

Remote Control
Manual

HP 37717C
Communications
Performance Analyzer

© Copyright Hewlett-Packard Ltd.1998

All rights reserved.
Reproduction, adaption,
or translation without prior
written permission is
prohibited, except as
allowed under the
copyright laws.

HP Part No. 37717-90430

First edition, 11/98

Printed in U.K.

Warranty

The information contained
in this document is subject
to change without notice.

*Hewlett-Packard makes no
warranty of any kind with
regard to this material,
including, but not limited
to, the implied warranties
or merchantability and
fitness for a particular
purpose.*

Hewlett-Packard shall not
be liable for errors
contained herein or for
incidental or
consequential damages in
connection with the
furnishing, performance,
or use of this material.

WARNING

Warning Symbols Used on the Product



The product is marked
with this symbol when the
user should refer to the
instruction manual in order
to protect the apparatus
against damage.

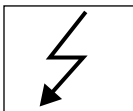

The product is marked
with this symbol to
indicate that hazardous
voltages are present



EN 60825 1991

The product is marked
with this symbol to
indicate that a laser is
fitted. The user should
refer to the laser safety
information in the
Calibration Manual.

HP Part Number 37717-90430

Printed in U.K. November 1998

**HP 37717C Communications
Performance Analyzer**

In This Book

This manual contains all the information necessary for remote control of the HP 37717C Communications Performance Analyzer.

1 Methods of Remote Control

Methods of Remote Control	1-2
Connecting the HP 37717C to HP-IB	1-3
Operating Distances	1-3
Communication with the System Controller	1-3
Connecting the HP 37717C to RS-232-C	1-4
Terminal Mode	1-4
Computer Mode	1-6
Communication with the Terminal/Computer	1-6
Connecting the HP 37717C to a LAN	1-10
Current Settings	1-11
New Settings (BOOTP)	1-11
New Settings (Keyboard Entry)	1-12
To Initialize the HP 37717C	1-14
Remote Control Hints & Tips	1-15
Default Settings	1-15
Instrument Coupling	1-15
Error Checking	1-15
Command Completion	1-16
Setup Delays	1-16
Status Registers	1-16
Gating Control	1-17
Frequency Offsets	1-18
User Locks	1-18

2 Common Commands

Common Commands	2-3
SCPI Command Format	2-3
Command Syntax	2-3

SCPI Long Form Command Headers	2-4
Linking Command Statements	2-4
Parameters	2-4
Remote Control Commands	2-6
Instrument Options	2-7
INSTRument subsystem	2-8
SOURce subsystem	2-9
SOURce subsystem - Transmitter Common Commands	2-11
INPut subsystem	2-14
SENSe subsystem	2-15
SENSe subsystem - Receiver Common Commands	2-17
SENSe subsystem - Test Timing	2-20
SENSe subsystem - Analysis Control	2-22
SENSe subsystem - Result Returning Commands	2-22
Common Results	2-22
SENSe subsystem - Trouble Scan Results	2-23
Common System Commands	2-26
SENSe subsystem - Configuring Graphics	2-27
SENSe subsystem - Managing Graphics Stores	2-29
SENSe subsystem - Retrieving Graphics Store Data	2-31
SENSe subsystem - Retrieving Data for a Single Graph	2-33
SENSe subsystem - Obtaining Graphics End of Measurement Results	2-35
STATus subsystem	2-44
SYSTEM Subsystem	2-47
IEEE common capabilities	2-62

3 PDH Command Reference

PDH Command Reference	3-3
OUTPut subsystem	3-4
SOURce subsystem- Transmitter Unstructured PDH Commands	3-9
SOURce subsystem -Transmitter Structured PDH Commands	3-17

SOURce subsystem - Transmitter SPDH Test Signal Settings Commands 3-28

SOURce subsystem - Transmitter SPDH Test Function Commands 3-36

INPut subsystem 3-51

SENSE subsystem - Receiver Unstructured PDH Settings 3-57

SENSE subsystem - Receiver Structured PDH Settings 3-62

SENSE subsystem - Receiver SPDH Test Signal Settings Commands 3-68

SENSE subsystem - Receiver SPDH Test Function Commands 3-74

SENSE subsystem - Analysis Control 3-75

SENSE subsystem - Alarm Scan Control 3-80

SENSE subsystem - SPDH Round Trip Delay Control 3-81

SENSE subsystem - Result Returning Commands 3-82

- Unstructured PDH Short Term Results 3-82
- Unstructured PDH Cumulative Results 3-82
- Unstructured PDH and Payload G.821 Analysis Results 3-83
- Unstructured PDH M.2100 Analysis Results 3-83
- Unstructured PDH FAS Error Analysis Results 3-84
- Unstructured PDH CRC Error Analysis Results 3-84
- Unstructured PDH REBE Error Analysis Results 3-85
- Unstructured PDH Alarm Seconds Results 3-85
- Frequency Results (PDH and SPDH) 3-86
- 3-86
- Structured PDH Short Term Results 3-86
- Structured PDH Cumulative Results 3-88
- Structured PDH and Payload G.821 Analysis Results 3-89
- Structured PDH 140 Mb/s G.826 Analysis Results 3-89
- Structured PDH 34 Mb/s G.826 Analysis Results 3-90
- Structured PDH 8 Mb/s G.826 Analysis Results 3-91
- Structured PDH 2 Mb/s G.826 Analysis Results 3-92
- Structured PDH DS1 G.826 Analysis Results 3-93
- Structured PDH DS3 G.826 Analysis Results 3-94
- Structured PDH BIT G.826 Analysis Results 3-95

Structured PDH M.2100 Analysis Results	3-95
Structured PDH M.2110 Analysis Results	3-97
Structured PDH M.2120 ANALysis Results	3-98
Structured PDH 2 Mb/S FAS Error Analysis Results	3-98
Structured PDH 8 Mb/S FAS Error Analysis Results	3-99
Structured PDH 34 Mb/S FAS Error Analysis Results	3-99
Structured PDH 140 Mb/S FAS Error Analysis Results	3-100
Structured PDH CRC Error Analysis Results	3-100
Structured PDH REBE Error Analysis Results	3-101
Structured PDH Alarm Seconds Results	3-102
Structured PDH Round Trip Delay Results	3-102
FETCh subsystem	3-103

4 SDH Command Reference

SDH Command Reference	4-3
OUTPut subsystem	4-4
SOURce subsystem - Transmitter SDH Settings Commands	4-7
SDH Clock settings	4-7
Thru mode settings	4-9
SDH Mapping Settings	4-11
AU Layer Selection	4-11
TU Layer Selection	4-12
Payload Layer Selection	4-13
TUG Channel	4-14
TU Payload and Test Pattern	4-15
Background Settings	4-18
Old Commands	4-22
SOURce subsystem - Transmitter SDH OVERHEAD SETUP	4-23
SOURce subsystem - Transmitter SDH Test Function Commands	4-36

INPut subsystem 4-63

SENSE subsystem - Receiver SDH Settings 4-67

- SDH Mapping settings 4-67
- AU Layer Selection 4-68
- TU Layer Selection 4-68
- Payload Layer Selection 4-69
- TUG Channel 4-70
- TU Payload and Test Pattern 4-71
- Old Commands 4-75

SENSE subsystem - Receiver SDH Test Function Commands 4-76

SENSE subsystem - Alarm Scan Control 4-83

SENSE subsystem - SDH Tributary Scan Control 4-85

SENSE subsystem - Optical Power Measurement Settings 4-87

SENSE subsystem - Result Returning Commands 4-88

- Frequency Results (SDH) 4-88
- SDH Short Term Results 4-88
- SDH Cumulative Results 4-89
- SDH RS B1 BIP Analysis Results 4-90
- SDH MS B2 BIP Analysis Results 4-90
- SDH Path MS FEBE Analysis Results 4-91
- SDH Path B3 BIP Analysis Results 4-92
- SDH Path FEBE Analysis Results 4-92
- SDH Path IEC Analysis Results 4-93
- SDH Tributary Path BIP Analysis Results 4-93
- SDH Tributary Path FEBE Analysis Results 4-94
- SDH Block Based Bit Analysis Results 4-94
- SDH M.2101 Analysis Results 4-95
- SDH Service Disruption Results 4-96
- SDH Optical Power Result 4-97
- SDH Pointer Activity Results 4-97
- SDH Alarm Seconds Results 4-98

FETCh subsystem 4-99

5 SONET Command Reference

- SONET Command Reference 5-3
- OUTPut subsystem 5-4
- SOURce subsystem - Transmitter SONET Settings Commands 5-7
 - SONET Clock settings 5-7
 - Thru mode settings 5-9
 - SONET Mapping Settings 5-11
 - SPE Layer Selection 5-11
 - VT Layer Selection 5-12
 - Payload Layer Selection 5-13
 - VT Group 5-13
 - VT Payload and Test Pattern 5-14
 - Background Settings 5-18
- SOURce subsystem - Transmitter SONET OVERHEAD SETUP 5-21
- :SOURce subsystem - Transmitter SONET Test Function Commands 5-32
- INPut subsystem 5-59
- SENSe subsystem - Receiver SONET Settings 5-63
 - SONET Mapping settings 5-63
 - SPE Layer Selection 5-64
 - VT Layer Selection 5-64
 - Payload Layer Selection 5-65
 - VT Group 5-66
 - VT Payload and Test Pattern 5-67
- SENSe subsystem - Receiver SONET Test Function Commands 5-71
- SENSe subsystem - Alarm Scan Control 5-77
- SENSe subsystem - SONET Tributary Scan Control 5-79
- SENSe subsystem - Optical Power Measurement Settings 5-81
- SENSe subsystem - Result Returning Commands 5-82
 - Frequency Results (SONET) 5-82
 - SONET Short Term Results 5-82
 - SONET Cumulative Results 5-83
 - SONET Section B1 BIP (CV-S) Analysis Results 5-84

SONET Line B2 BIP (CV-L) Analysis Results 5-84
SONET Line FEBE (REI-L) Analysis Results 5-85
SONET Path B3 BIP (CV-P) Analysis Results 5-85
SONET Path FEBE (REI-P) Analysis Results 5-86
SONET CV-IEC Analysis Results 5-86
SONET Virtual Tributary Path BIP (CV-V) Analysis Results 5-87
SONET Virtual Tributary Path FEBE (REI-V) Analysis Results 5-87
SONET Block Based Bit Analysis Results 5-88
SONET M.2101 Analysis Results 5-88
SONET Service Disruption Results 5-90
SONET Optical Power Result 5-90
SONET Pointer Activity Results 5-90
SONET Alarm Seconds Results 5-91
FETCh subsystem 5-93

6 ATM Command Reference

ATM Command Reference 6-3
OUTPut subsystem 6-4
SOURce subsystem- Transmitter ATM Commands 6-6
INPut subsystem 6-20
SENSE subsystem - Receiver ATM Settings 6-22
 ATM Layer 6-22
SENSE subsystem - Result Returning Commands 6-30
 ATM Short Term Results 6-30
 ATM Cumulative Results 6-31
 ATM EM BIP Analysis Results 6-33
 ATM FEBE/REI Analysis Results 6-33
 ATM REBE Analysis Results 6-34
 ATM CRC4 Analysis Results 6-34

ATM Alarm Seconds Results 6-35
ATM Mean Cell Transfer Delay Results 6-35
FETCh subsystem 6-36

7 Jitter Command Reference

Jitter Command Reference 7-3
OUTPut subsystem 7-4
SOURce subsystem - Transmitter Jitter Commands 7-6
INPut subsystem 7-18
SENSE subsystem - Receiver Jitter Settings 7-21
SENSE subsystem - Result Returning Commands 7-24
 Jitter/Wander Results 7-24
FETCh subsystem 7-26

8 Status Reporting

Status Reporting 8-2
 Status Byte 8-5
 Standard Event Status Register 8-6
 QUEStionable Status Register 8-7
 OPERation Status Register 8-8
 INSTrument Status Register 8-9
 DATA Status Register 8-10
 PDH Status Register 8-11
 FAS Status Register 8-12
 BINary Status Register 8-13
 SDH Status Register 8-14
 SDH2 Status Register 8-15

SONet Status Register	8-16
SONet2 Status Register	8-17
JITTer Status Register	8-18
SPDH Status Register	8-19
M140 Status Register	8-20
M34 Status Register	8-21
M8 Status Register	8-22
M2 Status Register	8-23
DS3 Status Register	8-24
DS2 Status Register	8-25
DS1 Status Register	8-26
ATM Status Register	8-27
DISK Status Register	8-28
Variations in BINARY Input to DATA Status Register	8-31
Programmed Status Reporting	8-32

9 General Information

General Information	9-2
SCPI Overview	9-2
HP-IB Universal Commands	9-3
Device Clear (CLEAR)	9-3
Serial Poll (SPOLL)	9-3
Remote Enable (REMOTE)	9-3
Local Lockout (LOCAL LOCKOUT)	9-4
Local (LOCAL)	9-4

10 Application Program Examples

Initializing the HP 37717C	10-2
Setup the HP 37717C PDH Tx (Main Settings)	10-3
Setup the HP 37717C PDH Rx (Main Settings)	10-4
Setup the HP 37717C PDH Tx (Main & Structured Settings)	10-5
Setup the HP 37717C PDH Rx (Main & Structured Settings)	10-7
Setup the HP 37717C PDH Tx to add Errors & Alarms	10-8
Setup the HP 37717C PDH Rx to perform Bit Error Measurements	10-9
Setup the HP 37717C SDH Tx	10-10
Setup the HP 37717C SDH Rx	10-12
Setup the HP 37717C SDH Tx to add Errors & Alarms	10-13
Setup the HP 37717C SDH Tx Overhead Bytes	10-14
Setup the HP 37717C SDH Tx for Overhead Byte Sequencing	10-15
Perform HP 37717C SDH Rx Measurements	10-16
Setup the HP 37717C SDH Rx to retrieve Overhead Monitor Bytes	10-17
Setup the HP 37717C SDH Rx to perform Overhead Byte Capture	10-18
Setup the HP 37717C SONET Tx	10-19
Setup the HP 37717C SONET Rx	10-21
Setup the HP 37717C SONET Tx to add Errors & Alarms	10-22
Setup the HP 37717C SONET Tx Overhead Bytes	10-23
Setup the HP 37717C SONET Tx for Overhead Byte Sequencing	10-24
Perform HP 37717C SONET Rx Measurements	10-25
Setup the HP 37717C SONET Rx to retrieve Overhead Monitor Bytes	10-26
Setup the HP 37717C SONET Rx to perform Overhead Byte Capture	10-27

11 Backwards Compatibility

Backwards Compatibility	11-2
-------------------------	------

12 SCPI Error Messages

SCPI Error Messages 12-2

General Index

Methods of Remote Control

Methods of Remote Control

Methods of Remote Control

The HP 37717C can be remotely controlled in one of four ways :

HP-IB Options

A3B, A3D (1A8) Provides a parallel interface that allows the connection of other devices to the system for example : Frequency Counter; Printer; Signal Generator. Allows great flexibility in communicating data and controlling data and provides one of the easiest methods of constructing automatic systems. If long distance communication is required, suitable HP-IB Extenders must be connected within the test system at both ends of the communication link.

RS-232-C Options

A3B, A3D (1CW) Provides a serial interface that can be connected directly to the RS-232-C port of a terminal or computer. Only the controller and the HP 37717C can be connected within the system. If long distance communication is required, the HP 37717C can be connected directly to the RS-232-C port of a Modem and carried over a telephone line.

LAN Option A3B

(1F7) Provides a parallel interface that allows the connection of other instruments and controllers to the system for example : workstations; other HP 37717C's; other test sets that have a LAN interface.

DNA Option USS

Provides control via a Front Panel displayed on a PC connected to a LAN. Other test sets that have the Virtual Remote capability can be connected to the LAN and controlled via the same PC. *See HP E4540A Manual, HP part number E4540-90004.*

Methods of Remote Control

Connecting the HP 37717C to HP-IB

The following points should be considered when connecting the HP 37717C to HP-IB :

- Operating distances
- Communication with the system controller

Operating Distances

1. The total length of HP-IB cable must not exceed 2 meters (6 feet) × the number of devices in the system.
2. The total length of HP-IB cable, used to interconnect all devices in the system, must not exceed 20 meters (65 feet).

Operating distances can be increased by using HP-IB Extenders, HP 37204A or HP 37201A :

Up to 1250 meters use HP 37204A.

Over 1250 meters use two HP 37201A and two suitable Modems.

Communication with the System Controller

Each device in the system must have a unique address to allow the controller to access each one individually. On the HP 37717C the address is set on the OTHER display under REMOTE CONTROL :

To set the HP-IB Address press OTHER; REMOTE CONTROL and set the display as shown opposite. Address 5 has been selected but any Address in the range 0 to 30 can be selected.

FUNCTION	[REMOTE CONTROL]
REMOTE CONTROL PORT	[HP-IB]
PRINTER PORT	[DISK]
ADDRESS	[5]
SRQ STATE	
ERROR NUMBER	
STATUS:	
HP-IB	RS232
LAN	MULTIPLE WINDOW

Methods of Remote Control

Connecting the HP 37717C to RS-232-C

Two methods of controlling the HP 37717C via RS-232-C are available :

Terminal	Simple method of control on a command by command basis.
Computer	More extensive method of control allows programs to be run.

Terminal Mode

Terminal mode is provided to allow the HP 37717C to be controlled by a "dumb" terminal and provides the following features :

When connection is established via RS-232-C the HP 37717C responds with a "prompt".

Any command sent to the HP 37717C is echoed back to the terminal to provide a local record.

If a mistake is made in the command, the appropriate SCPI Error Message and the "entered" command is returned to the terminal to provide a local record.

A command history buffer is provided with a capacity of 20 commands. This allows frequently used commands to be retransmitted without having to retype the command :

To list the history buffer contents type : **!l** (lower case L)

To retransmit the last Command sent type :

To retransmit a previously sent command type : **!n** where n = the commands listed number.

When REMOTE CONTROL PORT [RS232] is selected on the OTHER REMOTE CONTROL display the HP 37717C acts as DCE (Data Communications Equipment). Dumb terminals act as DTE (Data Terminal Equipment). This makes connection of the HP 37717C to a dumb terminal straightforward as shown in Table 1-1.

RS-232-C cable HP Part Number 5060-4461 will provide this connection.

Methods of Remote Control

Table 1-1

HP 37717C (Options A3B & A3D) to RS-232-C Terminal

37717C Pin #	Signal	Terminal Pin #	Signal
2	Transmit Data (TX)	2	Transmit Data (TX)
3	Receive Data (RX)	3	Receive Data (RX)
5	Signal Ground	7	Signal Ground

RS-232-C cable HP Part Number 24542U will provide this connection.

Connection via a Modem

Full Modem control is not possible and the Modem should be configured to force DSR, CD, CTS and DTR true.

Since Modems are always configured as DCE (Data Communications Equipment), the same as the HP 37717C, a crossover is required in the three wire connection as shown in Table 1-2.

Table 1-2

HP 37717C (Options A3B & A3D) to Modem

37717C Pin #	Signal	Modem Pin #	Signal
2	Transmit Data (TX)	3	Receive Data (RX)
3	Receive Data (RX)	2	Transmit Data (TX)
5	Signal Ground	7	Signal Ground

RS-232-C cable HP Part Number 24542M will provide this connection.

Methods of Remote Control

Computer Mode

Computer mode is provided to allow the HP 37717C to be controlled by a RS-232-C computer allowing programs to be run. Unlike Terminal mode commands are not echoed back and SCPI Error Messages are not returned unless the appropriate query command is issued.

When REMOTE CONTROL PORT [RS232] is selected on the OTHER REMOTE CONTROL display the HP 37717C acts as DCE (Data Communications Equipment). The Computer should be configured to act as DTE (Data Terminal Equipment). This makes connection of the HP 37717C to a computer straightforward as shown in Table 1-3.

Table 1-3

HP 37717C (Option A3B & A3D) to RS-232-C Computer

37717C Pin #	Signal	Computer Pin #	Signal
2	Transmit Data (TX)	2	Transmit Data (TX)
3	Receive Data (RX)	3	Receive Data (RX)
5	Signal Ground	7	Signal Ground

RS-232-C cable HP Part Number 24542U will provide this connection.

Connection via a Modem



Full Modem control is not possible and the Modem should be configured to force DSR, CD, CTS and DTR true.

Since Modems are always configured as DCE (Data Communications Equipment), the same as the HP 37717C, a crossover is required in the three wire connection as shown in Table 1-2 .

Communication with the Terminal/Computer

Remote control via RS-232-C requires that the HP 37717C RS-232-C interface settings match those of the terminal/computer. These settings are made on the OTHER display under REMOTE CONTROL.

Methods of Remote Control

Using  ,  and the display softkeys set REMOTE CONTROL PORT [RS232]. Set CONTROLLER TYPE, XON/XOFF, SPEED, PARITY and STOP BITS to match the settings on your terminal/computer.

FUNCTION	[REMOTE CONTROL]
REMOTE CONTROL PORT	[RS232]
PRINTER PORT	[DISK]
CONTROLLER TYPE	[TERMINAL]
XON/XOFF	[RX & TX]
SPEED	[9600 BRUD]
PARITY (7 BIT DATA)	[ODD]
STOP BITS	[1]
ERROR NUMBER	

STATUS: COMPUTER TERMINAL MULTIPLE WINDOW

Methods of Remote Control

Controlling the HP 37717C

The simplest way to verify the connection and become familiar with remote RS-232-C operation is to send a few commands and observe their effect. In this example using a terminal we will :

- Take the HP 37717C under remote control
- Initialize the HP 37717C
- Read the contents of the error register
- Start a test period
- Add errors
- Obtain the result (Option dependent)
- Return the HP 37717C to local operation

NOTE

Select CONTROLLER TYPE [TERMINAL] on the OTHER REMOTE CONTROL display and connect the PDH OUT port to the PDH IN port for the duration of this exercise.

Table 1-4

HP 37717C to RS-232-C Computer

Terminal Input	Comment
:SYST:REM	Takes the HP 37717C under remote control. On the instrument the indicator above LOCAL is lit.
*RST	Default settings, registers cleared.
:SYST:ERR?	The SCPI Error Message and number can be read, even in local operation mode. (+0, "No error")
:SENS:DATA:TEL:TEST :TYPE MAN	Selects a manual test period.
:SENS:DATA:TEL:TEST ON	Starts the manual test period. On the instrument the indicator above RUN/STOP is lit.

Methods of Remote Control

Table 1-4

HP 37717C to RS-232-C Computer

Terminal Input	Comment
:SOUR:DATA:TEL:ERR :BIT ONCE	Adds a single bit error.
:SOUR:DATA:TEL:ERR :BIT ONCE	Adds a single bit error.
:SOUR:DATA:TEL:ERR :BIT ONCE	Adds a single bit error.
:SENS:DATA:TEL:TEST OFF	Halts the manual test period. On the instrument the indicator above RUN/STOP is extinguished.
:SENS:DATA "ECO:PDH :BIT"	Option UKK, Unstructured PDH -Returns the bit error count in numeric form, in this example 3.
or	
:SENS:DATA "ECO:SPDH :BIT" RETURN	Option UKJ, Structured PDH - Returns the bit error count in numeric form, in this example 3.
:SYST:LOC	Returns the HP 37717C to local control. On the instrument the indicator above LOCAL is extinguished.

Methods of Remote Control

Connecting the HP 37717C to a LAN

Two methods of controlling the HP 37717C via a LAN are available :

Terminal Simple method of control on a command by command basis.

Computer More extensive method of control allows programs to be run.

The following information should be obtained from the LAN System Administrator before connecting to the LAN:

- Internet address (Example 015.144.180.205)
- Subnet Mask (Example 255.255.248.0).
- Default Gateway IP Address (Example 15.144.176.1).

The PORT NUMBER and MAC ADDRESS are assigned to the HP 37717C at the time of shipment.

Connect the HP 37717C LAN interface to the LAN network.

The HP 37717C must now be configured to accept the IP address, Subnet Mask and Default Gateway IP Address.

Press **OTHER**, **REMOTE CONTROL**
and set up the display as shown opposite.

The HP 37717C can be configured to accept the IP address, Subnet Mask and Default Gateway IP Address in one of two ways:

FUNCTION		[REMOTE CONTROL]
REMOTE CONTROL PORT		[LAN]
PRINTER PORT		DISK
CONFIGURATION		[CURRENT SETTINGS]
IP ADDRESS		15.144.181.41
PORT NUMBER		5001
SUBNET MASK		255.255.248.000
GATEWAY IP ADDRESS		15.144.175.181
MAC ADDRESS		080090000000
ERROR NUMBER		
STATUS:		
HP1B	RS232	LAN
MULTIPLE WINDOW		

Methods of Remote Control

Current Settings

The IP Address, Subnet Mask and Gateway IP Address will adopt the current settings.

The Port Number and MAC Address are displayed for information.

FUNCTION	[REMOTE CONTROL]
REMOTE CONTROL PORT	[LAN]
PRINTER PORT	DISK
CONFIGURATION	<input checked="" type="radio"/> CURRENT SETTINGS
IP ADDRESS	15.144.181.41
PORT NUMBER	5001
SUBNET MASK	255.255.248.000
GATEWAY IP ADDRESS	15.144.175.181
MAC ADDRESS	080090000000
ERROR NUMBER	
STATUS:	
<input checked="" type="radio"/> CURRENT SETTINGS	<input type="radio"/> NEW SETTINGS
<input type="radio"/> MULTIPLE WINDOW	

New Settings (BOOTP)

To use BOOTP your system administrator must set up a BOOTP server on the network.

When YES is selected the power must be cycled on the HP 37717C to allow for a change of settings.



When power is restored the HP 37717C will issue BOOTP requests until it receives a reply from a suitably configured BOOTP server.



FUNCTION	[REMOTE CONTROL]
REMOTE CONTROL PORT	[LAN]
PRINTER PORT	DISK
CONFIGURATION	[NEW SETTINGS]
USE BOOTP	<input checked="" type="radio"/> YES
NEW Settings take effect on next power up	
ERROR NUMBER	
STATUS:	
<input type="radio"/> NO	<input type="radio"/> YES
<input type="radio"/> MULTIPLE WINDOW	

The Settings of IP Address, Subnet Mask and Gateway IP Address will be adopted as the Current Settings.

Methods of Remote Control



New Settings (Keyboard Entry)

Use **DECREASE DIGIT**   and **INCREASE DIGIT** to set the IP Address, Subnet Mask and Gateway IP Address.

Use  and  to move between the IP Address, Subnet Mask and Gateway IP Address.

The New Settings will not become active until the power is cycled (power off/ power on) on the HP 37717C.

FUNCTION	[REMOTE CONTROL]
REMOTE CONTROL PORT	[LAN]
PRINTER PORT	[DISK]
CONFIGURATION	[NEW SETTINGS]
USE BOOTP	[NO]
IP ADDRESS	[15 144 180 205]
SUBNET MASK	[15 144 180 205]
GATEWAY IP ADDRESS	[15 144 180 205]
NEW Settings take effect on next power up	
ERROR NUMBER	

STATUS:
DECREASE DIGIT **INCREASE DIGIT**   **MULTIPLE WINDOW**

The entered New settings are checked to ensure they conform to the relationships that should exist between the IP Address, Subnet Mask and Gateway IP Address. If the entered data contravenes these relationships, the HP 37717C will change the data to more sensible values.

Configuration

The HP 37717C can only accept one tcp connection at a time and it cannot establish an outgoing call. The connection has to be directed to port 5001.

For Example (from a UNIX system):

```
telnet <IP address> 5001
```

If ping <IP address> is issued (from a UNIX system), commands issued will be echoed at the local end of the connection.

Controlling the HP 37717C

The simplest way to verify the connection and become familiar with remote LAN operation is to send a few commands and observe their effect. In this example using a terminal we will:

- Take the HP 37717C under remote control
- Initialize the HP 37717C
- Read the contents of the error register
- Start a test period
- Add errors
- Obtain the result (Option dependent)
- Return the HP 37717C to local operation

Methods of Remote Control

NOTE

Connect the PDH OUT port to the PDH IN port for the duration of this exercise.

Table 1-5 HP 37717C to RS-232-C Computer

Terminal Input	Comment
:SYST:REM	Takes the HP 37717C under remote control. On the instrument the indicator above LOCAL is lit.
*RST	Default settings, registers cleared.
:SYST:ERR?	The SCPI Error Message and number can be read, even in local operation mode. (+0, "No error")
:SENS:DATA:TEL:TEST :TYPE MAN	Selects a manual test period.
:SENS:DATA:TEL:TEST ON	Starts the manual test period. On the instrument the indicator above RUN/STOP is lit.
:SOUR:DATA:TEL:ERR :BIT ONCE	Adds a single bit error.
:SOUR:DATA:TEL:ERR :BIT ONCE	Adds a single bit error.
:SOUR:DATA:TEL:ERR :BIT ONCE	Adds a single bit error.
:SENS:DATA:TEL:TEST OFF	Halts the manual test period. On the instrument the indicator above RUN/STOP is extinguished.
:SENS:DATA "ECO:PDH :BIT"	Option UKK, Unstructured PDH -Returns the bit error count in numeric form, in this example 3.
or	
:SENS:DATA? "ECO:SPDH :BIT"	Option UKJ, Structured PDH -Returns the bit error count in numeric form, in this example 3.
:SYST:LOC	Returns the HP 37717C to local control. On the instrument the indicator above LOCAL is extinguished.

Methods of Remote Control

To Initialize the HP 37717C

Regardless of the current setup the following command will initialize the HP 37717C. It sets the HP 37717C to the factory default settings and clears all registers.

*RST

It is recommended that you do not rely on default settings but program each setting to what you require.

Remote Control Hints & Tips

Remote Control Hints & Tips

The following section gives some Hints & Tips on how to control the HP 37717C via remote control. Before writing any program to control the HP 37717C it may help to manually go through the steps required to setup the desired configuration. The order in which you should send the corresponding SCPI commands will usually follow the order in which you set up the HP 37717C's Front Panel. This can be seen in the Application Examples listed in the Manual. These could be used as a starting point in order to find the SCPI commands that correspond to particular HP 37717C Front Panel settings.

Default Settings

In general, default settings should not be assumed. It is recommended that each instrument setting should be explicitly programmed to the desired value.

Also commands that affect higher level settings such as Signal Rate or Payload Type should be sent before commands to set up lower level settings e.g. Pattern. This is because, in some cases, higher level setting changes can affect the values of lower settings.

Instrument Coupling

If you wish to set the HP 37717C Transmitter and Receiver to the same settings then you can save time by selecting Transmitter/Receiver Coupling and then programming the Receiver only.

To turn coupling on use the :INSTRument:COUPlE RTTX command.

Error Checking

It is recommended that, when sending SCPI commands to the HP 37717C, you also periodically send the SYSTem:ERRor? command to check for any Remote Control Errors reported by the instrument. This command returns 0, "No Error" if there are no errors in the error queue. If the SYSTem:ERRor? command is sent after every setup command then it makes debugging any reported errors much easier since you will know exactly which command caused the error.

The actual error queue within the HP 37717C can be cleared by sending the *CLS command.

Remote Control Hints & Tips

Command Completion

When programming the instrument over RS-232, it is important to realize that a buffer (of 128 bytes) exists in the HP 37717C between the RS-232 port and the SCPI parser.

The effect of this is that even if the HP 37717C accepts the last character of a command, it cannot be assumed that it will immediately be executed - there could be several commands ahead of this one waiting in the buffer.

If you need to know when a command, or sequence of commands has been accepted by the instrument, follow them with a query command. When the response to the query command is returned, then you know that all commands prior to that have been executed.

Suitable query commands to use are *OPC? or SYST:ERRor? (which also gives the additional benefit of error checking as described above).

Note that this effect does not apply with HPIB. When HPIB is used to remotely control the HP 37717C then, after the last character of a SCPI command has been accepted by the instrument, its execution is imminent. However, it is still good practice to send a SYSTem:ERRor? after each command in order to check for error free completion.

Setup Delays

Even after the HP 37717C has accepted a SCPI command it may take some time for it to execute the requested operation (e.g. payload change, single error add). It is therefore recommended that at least 200ms is allowed after the command has completed before expecting the instrument operation to occur. One way of determining if such delays exist is to perform the desired operation manually using the HP 37717C's Front Panel and checking if there is any noticeable delay in execution.

Status Registers

Status registers in general are only updated every 100ms by the HP 37717C. Therefore you should avoid reading them any faster than that since, although it does not do any harm if they are read faster, it means that less processing power will be available to update the display.

If you need to detect a status register bit that is momentarily changing state, avoid using the condition register in the hope of catching both states. Instead it is much better to program the PTRansition and NTRansition registers to catch the event of interest, and then use the event register to monitor for the event.

Remote Control Hints & Tips

For example, say you wished to detect when the K1 and K2 bytes in the Multiplex Section Line Overhead of a STM-1/STS-3 signal had changed. There is a K1K2 bit defined (DB6) in the SDH2/SONet2 Status Register that is set when these bytes change value.

However, if you monitored the SDH2/SONet2 status register simply by sending the STATus:SDH2:CONDition? or STATus:SON2:ConDition? command then it is very likely that you would miss any transition in the K1K2 bit.

A better method is as follows..

```
Set transition filter to pass positive      : STATus : SDH2 : PTR 64 ; NTR 0
transitions in K1K2 (DB6)                  : STATus : SON2 : PTR 64 ; NTR 0

Periodically read SDH2/SON2 event          : STATus : SDH2 : EVENT ?
register.                                   : STATus : SON2 : EVENT ?
Check for K1K2 (DB6) being set.
```

Using this technique you will detect any changes in the K1 and K2 bytes.

If you needed to monitor a number of status bits then using this method would not be ideal since it would have the disadvantage of having to regularly read a number of status registers. A general rule is to minimize the number of status register reads required and, to achieve this, use can be made of the Summary register. For details on how to use the Summary register and also the SRQ mechanism see Programmed Status Reporting on page 8-32.

Gating Control

There are a number of status register bits that can be used to indicate the state of the HP 37717C's measurement system.

When you send the start gating command to the HP 37717C you should check the MEAS bit (DB4) in the OPERation status register. This is because the HP 37717C takes a finite period of time (the actual length of time can be affected by factors such as whether Stored Measurement Graphics is selected or not) to start gating. When the MEAS bit is set to one it means that the HP 37717C is gating.

If it is required to retrieve Short Term results while the HP 37717C is gating then the STP bit (DB6) in the INSTRument status register can be used to determine when short term results can read i.e. when the first short term test period has completed.

The EOT bit (DB2) in the INSTRument status register can be used to determine when the HP 37717C gating period is complete.

Remote Control Hints & Tips

Frequency Offsets

If the HP 37717C Transmitter's PDH signal rate or frequency offset is changed it will take some time for the Internal VCXO's to settle. This is indicated on the HP 37717C's Front Panel by a flashing status message. The state of the VCXO's can also be checked by monitoring the LOC Bit (DB8) in the SPDH Status Register.

User Locks

User locks are a mechanism used within the HP 37717C to prevent the user selecting a particular instrument feature when some other selection takes priority. An example of this would be if you tried to modify the value of a SDH/SONET Overhead byte using the :SOURCE:DATA:TELEcom:SDH:OVERhead:DATA or :SOURCE:DATA:TELEcom:SONet:OVERhead:DATA command at the same time as a sequence was being generated in the same byte. If you tried to do this manually via the HP 37717C's Front PANEL than a status message warns you that this operation is not possible. If you tried to do it via remote control then a "-200, Execution Error" would result. The solution is to switch of the particular feature (in this example sequence generation) that has priority before sending the command.

SCPI Command Format, see page 2-3.

Remote Control Commands, see page 2- 6.

Instrument Options, see page 2-7.

INSTRument subsystem, see page 2-8.

SOURce subsystem, see page 2-9.

SOURce subsystem - Transmitter Common Commands, see page 2-11.

INPut subsystem, see page 2- 14.

SENSe subsystem, see page 2-15.

SENSe subsystem - Receiver Common Commands, see page 2- 17.

SENSe subsystem - Test Timing, see page 2-20.

SENSe subsystem - Analysis Control, see page 2-22.

SENSe subsystem - Trouble Scan Results, see page 2-23.

SENSe subsystem - Configuring Graphics,see page 2- 27.

SENSe subsystem - Managing Graphics Stores, see page 2- 29.

SENSe subsystem - Retrieving Graphics Store Data, see page 2-31.

SENSe subsystem - Retrieving Data for a Single Graph, see page 2- 33.

SENSe subsystem -Obtaining Graphics End of Measurement Results, see page 2-35.

STATus Subsystem, see page 2- 44.

SYSTem Subsystem, see page 2-47.

IEEE common capabilities, see page 2- 62.

Common Commands

Common Commands

Common Commands

Common Commands

Common Commands

This chapter contains general information on SCPI commands, and detailed information on the commands that are common for all types of instrument operation, i.e. PDH, SDH, SONET, ATM and Jitter.

SCPI Command Format

Instrument functions such as making measurements, retrieving data, and querying status, are performed by stringing together SCPI "nodes" into commands. The SCPI commands are based on a hierarchical structure called a "subsystem" that comprises a top level "root" node and one or more lower-level nodes and their parameters as follows:

:INPut:TELEcom:PDH:CODE CMI or AMI or HDB3

- :INPut is the root node
- :TELEcom is a second level node
- :PDH is a third level node
- :CODE is a fourth level node
- CMI, AMI and HDB3 are parameters of the fourth-level :CODE node.

Command Syntax

Commands are shown as a mix of upper and lowercase characters.

Commands can be abbreviated for shorter program line lengths. The uppercase characters define the abbreviated form of the command.

Commands are formed by linking the root node with lower-level nodes. A colon (:) is used to link nodes.

If the command requires a parameter, a space must separate the lowest level node and the parameter. If there is more than one parameter, a comma (,) is used to separate the parameters.

Common Commands

SCPI Command Format

An example of typical commands and their abbreviated form are shown below :

:INPut:TELEcom:PDH:CODE <AMI>	full Form
:INP:TEL:PDH:CODE <AMI>	abbreviated form
:SOURce:DATA:TELEcom:PDH:PAYLoad:PATtern <PRBS23>	- full form
:SOUR:DATA:TEL:PDH:PAYL:PATT <PRBS23>	- abbreviated form

SCPI Long Form Command Headers

The general rule for SCPI long form command headers that are greater than four characters in length is as follows:

- Abbreviated short form mnemonics - the first four characters from the long form command header are used unless the fourth character is a vowel. In such cases, the vowel is dropped and only the first three characters are used.
- If the command is four characters long then all four characters are used, irrespective of whether the fourth character is a vowel or not.

Linking Command Statements

Command statements can be linked using semicolons (;). For example :

```
:INPut:TELEcom:PDH:CODE <AMI>;:SOURce:DATA:TELEcom:PDH:  
PAYLoad:PATtern <PRBS23>
```

Parameters

In this manual, parameters are shown in angled brackets < >. There are five parameter types used in commands as listed in table 2-1.

Common Commands
SCPI Command Format

Table 2-1

Parameter Types

Parameter Types	Description
<Numeric>	All commonly used decimal numbers including optional signs, decimal points, and scientific notation. Examples are 123, 123E2, -123, -1.23E2, .123, .123E2 and 1.2300E-01. Special cases include MINimum and MAXimum. A numeric parameter can also be specified in hex, octal, and/or binary. Examples are #H7B, #Q173 and #B11110111.
<Boolean>	A single binary condition that is either true or false. Examples are ON, OFF, 1 and 0.
<Discrete>	Values that are represented by a string of alphanumeric characters. Examples are INTernal and EXTernal.
<String>	Any set of ASCII characters enclosed within single quotes or double quotes. Examples are '1111111111111111' and "0000000000000000".
<Block>	Used to transfer large quantities of related data. Blocks can be sent as definite length blocks (#<numeric><numeric>) or indefinite length blocks (#0).

Common Commands
Remote Control Commands

Remote Control Commands

The remote control commands in this manual have been grouped into Sections that relate to instrument functions. These have then been split into Subsystems

The Subsystems used in the HP 37717C are listed in table 2-2.

Table 2-2

SCPI Subsystems

Instrument Functions	Subsystem
To control SIGNAL OUT port, STM-1/STS-3 OUT port , Optical OUT port .	:OUTPut
To control instrument coupling.	:INSTrument
To control the transmitter.	:SOURce
To control the SIGNAL IN port, STM-1/STS-3 IN port , Optical IN port.	:INPut
To control the receiver, results and graphics	:SENSe
To obtain results directly accumulated by the instrument.	:FETCh
To control the instrument OTHER functions.	:SYSTem
To control Status Reporting.	:STATus

Instrument Options

The HP 37717C Communications Performance Analyzer is a modular product allowing a wide range of test options to be fitted. SCPI commands with the following node names need the appropriate options to be fitted.

PDH - needs unstructured PDH option

SPDH - needs structured PDH option

SDH - needs SDH option

SONET - needs SONET option

ATM - needs ATM option

JITTER - needs Jitter option

Commands are not valid unless the correct option has been fitted e.g.

:SOURCE:DATA:TELEcom:ATM:CBWidth <string> only works if an ATM option has been fitted.

Common Commands
INSTRUMENT subsystem

INSTRUMENT subsystem

The INSTRUMENT subsystem is used to control the coupling between the transmitter and the receiver as provided on the OTHER SETTINGS CONTROL display.

:INSTRUMENT:COUPLE <mode>

<mode> =	OFF	Independent
	RTTX	Coupled

After a reset the receiver and transmitter coupling will be OFF. If the instrument is testing and the receiver and transmitter are coupled, changing certain transmitter settings will generate an error because the coupled receiver setting cannot be changed because of testing lock.

The corresponding query returns the Coupling state in discrete form as listed above.

:INSTRUMENT:COUPLE?

Returns : <mode>

SOURce subsystem

The SOURce subsystem contains commands that allow the transmitter settings to be set.

The commands within the SOURce subsystem have been arranged as follows :

Chapter 2

SOURce subsystem - Transmitter Common Commands

Chapter 3

SOURce subsystem- Transmitter Unstructured PDH Commands



SOURce subsystem -Transmitter Structured PDH Commands



SOURce subsystem - Transmitter SPDH Test Signal Settings Commands



SOURce subsystem - Transmitter SPDH Test Function Commands



Chapter 4

SOURce subsystem - Transmitter SDH Settings Commands



SOURce subsystem - Transmitter SDH OVERHEAD SETUP



SOURce subsystem - Transmitter SDH Test Function Commands



Chapter 5

SOURce subsystem - Transmitter SONET Settings Commands



SOURce subsystem - Transmitter SONET OVERHEAD SETUP



:SOURce subsystem - Transmitter SONET Test Function Commands



Chapter 7

SOURce subsystem - Transmitter Jitter Commands



Chapter 6

SOURce subsystem- Transmitter ATM Commands



Common Commands

SOURce subsystem

Unstructured PDH and Structured PDH are mutually exclusive and therefore only one of these options will be present in any one instrument.

SDH, SONET and Jitter are allowed with both Unstructured and Structured PDH.

ATM is not available with Unstructured PDH.

Where commands are applicable to more than one category these are included in all the applicable categories.

SOURce subsystem - Transmitter Common Commands**SOURce subsystem - Transmitter Common Commands**

:SOURce:DATA:TELEcom:SOURce <discrete>

<discrete> =	PDH	UPDH or SPDH
	SDH	STM- 0/STM-1 Electrical
	SONet	As SDH (requires a SONET option)
	OPT1	STM-1 Optical (opt UH1)
	OC3	STS-3 Optical (opt UH1 and 120)
	OPT4	STM-0/STM-1/STM-4 Optical (opt 130)
	OC12	As OPT4 (opt 130)
	ATM	ATM

Selects the output port. The output characteristics of each port are controlled by the :OUTPut subsystem.

Recommended use: This command selects which transmitter output port is in use, and also selects the TRANSMITTER OUTPUT selection on the transmitter page. The parameters refer to the physical ports on the instrument but do not select the interface rate.

After this command has been used to select the applicable port and interface, the interface rate commands should be used to set the required line rate. See the Associated Commands.

Associated Commands: For each parameter of this command, the command to set the interface rate is listed here.

(Unstructured PDH) :OUTPut:TELEcom:PDH:RATE <discrete>

(Structured PDH) :OUTPut:TELEcom:SPDH:RATE <discrete>

(SDH) :OUTPut:TELEcom:SDH:RATE <discrete>

(SONET) :OUTPut:TELEcom:SONet:RATE <discrete>

(OPT1) None - only one rate (STM-1) is possible with module UH1

(OC3) None - only one rate (STS-3) is possible with module UH1

Common Commands

SOURce subsystem - Transmitter Common Commands

(OPT4) :OUTPut:TELEcom:OPT4:RATE <discrete>

(OC12) :OUTPut:TELEcom:OC12:RATE <discrete>

(ATM) :OUTPut:DATA:TELEcom:ATM:RATE <discrete>

The corresponding query returns the selected output port in discrete form as listed above.

:SOURce:DATA:TELEcom:SOURce?

Returns : <discrete>

:SOURce:DATA:TELEcom:TFUNction <discrete>

<discrete> =	NONE	Test function off
	SDH	
	SONet	
	PDHPayload	requires a SDH/SONET option
	PDH	SPDH options only
	ATM	
	UPDH	Unstructured PDH
	TRIBscan	Tributary scan
	SDISruption	Service Disruption

Selects the transmitter test function source.

The corresponding query returns the transmitter test function source in discrete form as shown above.

:SOURce:DATA:TELEcom:TFUNction?

Returns: <discrete>

:SOURce:DATA:TELEcom:ERRor:BIT <discrete>

Common Commands

SOURce subsystem - Transmitter Common Commands

<discrete> =	NONE	Off
	ONCE	Single Error Add

Selects the required bit error add rate.

This command is retained for backwards compatibility only. The recommended commands are:

:SOURce:DATA:TELEcom:SDH:ERRor:TYPE <discrete> and
:SOURce:DATA:TELEcom:SDH:ERRor:RATE <discrete> for SDH errors,
:SOURce:DATA:TELEcom:SONet:ERRor:TYPE <discrete> and
:SOURce:DATA:TELEcom:SONet:ERRor:RATE <discrete> for SONET errors,
:SOURce:DATA:TELEcom:SDH:PDHPayload:ERRor:TYPE <discrete> and
:SOURce:DATA:TELEcom:SPDH:ERRor:TYPE <discrete> for SDH PDH payload
errors, :SOURce:DATA:TELEcom:SONet:PDHPayload:ERRor:TYPE <discrete>
and :SOURce:DATA:TELEcom:SPDH:ERRor:TYPE <discrete> for SONET PDH
payload errors, and :SOURce:DATA:TELEcom:SPDH:ERRor:RATE <discrete> for
SPDH errors.

INPut subsystem

INPut subsystem

This subsystem controls the characteristics of the instrument's input ports.

:INPut:TELEcom:LEVel <discrete>

<discrete> = TERMinate
 MONitor

Sets the input level for the SDH, SONET, UPDH or SPDHelectrical input port when that port is selected by :SENSe:DATA:TELEcom:SENSe <discrete> , type= SDH, SONet or PDH.

The corresponding query returns the input level in discrete form, as listed above.

:INPut:TELEcom:LEVel?

Returns : <discrete>

SENSe subsystem

SENSe subsystem

The SENSE subsystem contains the commands that control the Receiver. These have been arranged in the following manner :

Chapter 2

SENSe subsystem - Receiver Common Commands

Chapter 3

SENSe subsystem - Receiver Unstructured PDH Settings



SENSe subsystem - Receiver Structured PDH Settings



SENSe subsystem - Receiver SPDH Test Signal Settings Commands



SENSe subsystem - Receiver SPDH Test Function Commands



Chapter 4

SENSe subsystem - Receiver SDH Settings



SENSe subsystem - Receiver SDH Test Function Commands



Chapter 5

SENSe subsystem - Receiver SONET Settings



SENSe subsystem - Receiver SONET Test Function Commands



Chapter 7

SENSe subsystem - Receiver Jitter Settings



Chapter 6

SENSe subsystem - Receiver ATM Settings



Chapter 2

SENSe subsystem - Test Timing











SENSe subsystem - Analysis Control



Common Commands

SENSe subsystem

Chapter 3	SENSe subsystem - Alarm Scan Control		PDH ALM SCAN
Chapter 4	SENSe subsystem - SDH Tributary Scan Control		SDH 
Chapter 5	SENSe subsystem - SONET Tributary Scan Control		SONET 
Channel 3	SENSe subsystem - SPDH Round Trip Delay Control		PDH TRIP DELAY
Channel 4	SENSe subsystem - Optical Power Measurement Settings		SDH
Channel 5	SENSe subsystem - Optical Power Measurement Settings		SONET
Channel 3	SENSe subsystem - Trouble Scan Results		
	SENSe subsystem - Result Returning Commands		
	SENSe subsystem - Configuring Graphics		
	SENSe subsystem - Managing Graphics Stores		
	SENSe subsystem - Retrieving Graphics Store Data		
	SENSe subsystem - Retrieving Data for a Single Graph		
	SENSe subsystem - Obtaining Graphics End of Measurement Results		

SENSe subsystem - Receiver Common Commands**SENSe subsystem - Receiver Common Commands****:SENSe:DATA:TELEcom:SENSe <discrete>**

<discrete> =	PDH	UPDH or SPDH (Option UKK, UKJ or 110)
	SDH	SDH Electrical (Option A3R or 120)
	SONet	As SDH (Option 120 only)
	OPT1	STM-1 Optical (Option UH1)
	OC3	STS-3 Optical (Option UH1 and 120)
	OPT4	STM-0/STM-1/STM-4 Optical (Option 130/1)
	OC12	As OPT4 (Option 130/1 and 120)
	ATM	ATM (Option UKN only)
	JITT	SDH Jitter

Selects the input port. The input characteristics of each port are controlled by the INPut subsystem.

Recommended use: This command selects which receiver input port is in use, and also selects the top level field on the receiver page. The parameters refer to the physical ports on the instrument but do not select the interface rate. After this command has been used to select the applicable port and interface, the interface rate commands should be used to set the required line rate. See the Associated Commands.

Associated Commands: For each parameter of this command, the command to set that interface's rate is listed here.

(PDH option UKK) :INPut:TELEcom:PDH:RATE <discrete>

(PDH options UKJ or 110) :INPut:TELEcom:SPDH:RATE <discrete>

(SDH) :INPut:TELEcom:SDH:RATE <discrete>

(SONet) :INPut:TELEcom:SONet:RATE <discrete>

(OPT1) None - only one rate (STM-1) is possible with module UH1

(OC3) None - only one rate (STS-3) is possible with module UH1

Common Commands

SENSe subsystem - Receiver Common Commands

(OPT4) :INPut:TELEcom:OPT4:RATE <discrete>

(OC12) :INPut:TELEcom:OC12:RATE <discrete>

(ATM) :INPut:TELEcom:ATM:RATE <discrete>

(JITTer) :INPut:TELEcom:SDH:RATE <discrete>

The corresponding query returns the selected input port in discrete form, as listed above.

:SENSe:DATA:TELEcom:SENSe?

Returns : <discrete>

:SENSe:DATA:TELEcom:AUTOsetup

Causes the receiver to perform an autosetup. The instrument attempts to lock onto the incoming signal by matching the clock rate, interface and payload patterns. If a match cannot be found, the receiver reverts to default settings.

If :INSTrument:COUPlE <mode> is set to RTTX, the transmitter will also adopt the autosetup conditions.

:SENSe:DATA:TELEcom:TEST <boolean>

<boolean> =	0 or OFF	Stop the current test
	1 or ON	Start a new test

Start/Stop the test as **RUN/STOP**.

The corresponding query returns the test state as 0 or 1.

:SENSe:DATA:TELEcom:TEST?

Returns : <boolean>

:SENSe:DATA:TELEcom:TFUNction <discrete>

<discrete>=	NONE	
	SDH	
	SONet	
	SDISruption	Service Disruption

Common Commands

SENSe subsystem - Receiver Common Commands

Sets the Receiver test function.

The corresponding query returns the receiver test function in discrete form as listed above.

:SENSe:DATA:TELeom:TFUNction?

Returns: <discrete>

Common Commands
SENSe subsystem - Test Timing

SENSe subsystem - Test Timing

:SENSe:DATA:TELEcom:TEST:TYPE <discrete>

<discrete> =	MANual	Manual Test period
	SINGle	Single Test period
	TIMed	Timed Start Test period

Selects the type of test period. If SING or TIM is selected, the duration is set using :SENS:DATA:TEL:TEST:PER. If TIM is selected, the start time is selected using :SENS:DATA:TEL:TEST:STAR.

The corresponding query returns the type of test period in discrete form, as listed above.

:SENSe:DATA:TELEcom:TEST:TYPE?

Returns : <discrete>

:SENSe:DATA:TELEcom:TEST:PERiod <numeric> <suffix>

<numeric> =	1 to 99	
<suffix> =	d	Days
<suffix> =	h	Hours
<suffix> =	m	Minutes
<suffix> =	s	Seconds

Sets the duration of the test period. Is only valid when :SENS:DATA:TEL:TEST:TYPE SING or TIM is selected.

The corresponding query returns the test duration.

:SENSe:DATA:TELEcom:TEST:PERiod?

Returns : <period> <numeric>,<suffix>

Common Commands

SENSe subsystem - Test Timing

:SENSe:DATA:TELEcom:TEST:STARt <numeric>,<numeric>,<numeric>,<numeric>,<numeric>

<numeric> =	1970 to 2069	Year
<numeric> =	1 to 12	Month
<numeric> =	1 to 31	Day
<numeric> =	0 to 23	Hour
<numeric> =	0 to 59	Minute

Sets the test period start time when :SENS:DATA:TEL:TEST:TYPE <TIM> is selected.

The corresponding query returns the test period start time in numeric form.

:SENSe:DATA:TELEcom:TEST:STARt?

Returns: <numeric>,<numeric>,<numeric>,<numeric>,<numeric>

:SENSe:DATA:TELEcom:STERm:PERiod <numeric>,<suffix>

<numeric> =	1 to 100	
<suffix> =	s	Seconds

Sets the short term results calculation period.

The corresponding query returns the short term results period.

:SENSe:DATA:TELEcom:STERm:PERiod?

Returns : <numeric>
<suffix>

Common Commands

SENSe subsystem - Analysis Control

SENSe subsystem - Analysis Control

:SENSe:DATA:TELEcom:TEST:SUSPend <boolean>

<boolean> =	0 or OFF	G821 Analysis
	1 or ON	Suspend test during Signal Loss

Sets the state of Analysis Control.

The corresponding query returns the state of Analysis Control as 0 or 1.

:SENSe:DATA:TELEcom:TEST:SUSPend?

Returns : <boolean>

SENSe subsystem - Result Returning Commands

Common Results

:SENSe:DATA? <"result">

Result =	"ETIME"	Elapsed Time
	"ASEconds:PLOSS"	Power Loss Alarm Seconds
	"ASEconds:PSLoss	Pattern Sync Loss Alarm Seconds

SENSe subsystem - Trouble Scan Results

SENSe subsystem - Trouble Scan Results

:SENSe:DATA:TELEcom:TSCan:TYPE?

Returns:	<discrete>	NTR	No Trouble
		ADET	Alarms Detected
		ERR	Errors Detected

Returns the Trouble Scan state.

:SENSe:DATA:TELEcom:TSCan:ERRors?

Returns:	<numeric>,<result>	
<numeric> =	0 to 4	Number of Troublescan error messages
<discrete>	See Table below	Error name and number of errors

Returns the number of active Trouble Scan error messages. If no error messages are active, returns 0. If error message is active, returns the type of error and the error count separated by a comma e.g.

2
FAS140 ERR, 6
BIT ERROR, 1

This indicates that 2 trouble scan error messages are active and 6 140 Mb/s frame errors and 1 bit error have occurred.

Common Commands

SENSe subsystem - Trouble Scan Results

Trouble Scan Results and Priority

SDH (Options US1[US5], A1T[A1U], A3R[A3S])	RS B1 BIP MS B2 BIP PATH B3 BIP VC3 PATH BIP TU2 BIP TU12 BIP A1A2 FRAME MS FEBE/MS-REI PATH FEBE/HP-REI PATH IEC /HP-IEC VC3 PATH FEBE TU2 FEBE TU12 FEBE BIT
SONET(Option 120)	CV-S (B1) CV-L (B2) CV-P (B3) CV-V (V5) A1A2 FRAME CV-IEC (DSn near-end errors except BIT) REI-L REI-P REI-V BIT (DSn far-end errors)
SPDH (Options UKJ[USA], UKL[USC])	CRC BIT CODE FAS 140M FAS 34M FAS 8M FAS 2M REBE
UPDH (Options UKK[USB])	CRC BIT CODE FRAME REBE

Common Commands

SENSe subsystem - Trouble Scan Results

ATM (Option UKN) + SDH	RS B1 BIP (SDH only) MS B2 BIP (SDH only) PATH B3 BIP (SDH only) Non Corrected HEC Corrected HEC Lost Cells Misinserted Cells Path FEBE/HP-REI Bit Errored Cells
ATM (Option UKN) +SPDH	EM BIP Non Corrected HEC Corrected HEC Lost Cells Misinserted Cells EM FEBE Bit Errored Cells

Common System Commands

SENSe subsystem - Configuring Graphics,

SENSe subsystem - Managing Graphics Stores,

SENSe subsystem - Retrieving Graphics Store Data,

SENSe subsystem - Retrieving Data for a Single Graph,

SENSe subsystem -Obtaining Graphics End of Measurement Results,

STATus Subsystem,

SYSTem Subsystem,

IEEE common capabilities

SENSe subsystem - Configuring Graphics

SENSe subsystem - Configuring Graphics

:SENSe:DATA:TELEcom:SMG <discrete>

<discrete> =	OFF	Graphics Off
	ON or T1Second	1 Second resolution
	T1Minutes	1 Minute resolution
	T15Minutes	15 Minute resolution
	T1Hour	1 Hour resolution

Sets the resolution of the stored measurement graphics (SMG).

The corresponding query returns the SMG resolution in discrete short form.

:SENSe:DATA:TELEcom:SMG?

Returns: <discrete>

:SENSe:DATA:TELEcom:SMG:RESolution <discrete>

<discrete> =	COMPRESS	Storage capacity 20,000 Events
	FULL	Storage capacity 10,000 Events

Sets the resolution of the graphics storage.

The corresponding query returns the storage resolution in discrete short form.

:SENSe:DATA:TELEcom:SMG:RESolution?

Returns: <discrete>

:SENSe:DATA:TELEcom:SMG:STORe <discrete>

<discrete> =	INTernal	Graphics store location
	DISK	Disk storage

Selects the storage location for the stored measurement graphics (SMG).

The corresponding query returns the storage location in discrete short form.

Common Commands

SENSe subsystem - Configuring Graphics

:SENSe:DATA:TELeom:SMG:STORe?

Returns: <discrete>

SENSe subsystem - Managing Graphics Stores

SENSe subsystem - Managing Graphics Stores

:SENSe:DATA:TELEcom:SMG:CATalog?

Returns: <numeric> = store number: range -9 to 0
 <numeric> = graph type: range 0 or 1 (1 -
 Demo; 0 -Graph)
 <numeric> = year: range 1970 to 2069
 <numeric> = month: range 1 to 12
 <numeric> = day: range 1 to 31
 <numeric> = hour: range 0 to 23
 <numeric>= minute: range 0 to 59
 <numeric> = number of samples: range 1 to n
 <numeric> = number of seconds per sample:
 1, 60, 900 or 3600

Requests a catalogue of the SMG store data. A record is described above is produced for each SMG store being used. The final record is followed by EOI.

:SENSe:DATA:TELEcom:SMG:SIZE?

Returns: <numeric> = size: always 70200
 <numeric> = stores used: range 0 to 70200

Requests the capacity of the graphics store and the number of store locations in use. The store size is a constant for a given instrument.

In the HP 37717C <size> is 70200 indicating that the maximum storage capacity is 70200 samples at the current resolution. <stores-used> indicates the number of samples currently allocated.

:SENSe:DATA:TELEcom:SMG:DELeTe <numeric>

 <numeric> = store: range -9 to 0

Deletes the given store.

Common Commands

SENSe subsystem - Managing Graphics Stores

:SENSe:DATA:TELEcom:SMG:DELEte:ALL

Deletes all stores.

:SENSe:DATA:TELEcom:SMG:SINFormation? <numeric>

This command returns details of the specified SMG store.

<numeric> = store: range -9 to 0

Returns:	<numeric>	1 60 900 3600	Number of seconds per sample
	<discrete>	COMP	Resolution: compressed or
	<discrete>	FULL	full.
	<non-standard>		Start Time & Date for store
	<numeric>		Store Duration in seconds

SENSe subsystem - Retrieving Graphics Store Data

SENSe subsystem - Retrieving Graphics Store Data

The data used to construct all the bar graphs within a given store location can be extracted from the instrument and processed in a PC.

Each bar graph is identified by a label. To obtain the labels use:

:SENSe:DATA:TELEcom:SMG:LABels? <numeric>

<numeric> =	-9 to 0	Graphics Store Location
	-10	Disk Storage

Returns all possible graph labels from the given SMG store even if some of those graphs are not applicable to the particular instrument configuration at the time the measurement was made.

A SMG graph is defined as:

- An error source Bar graph - Data from which the error source graph is constructed
- Alarm Bar graph - an 8 bit binary string recording the state of a group of alarms

Returns: (first row)	<numeric>
(other rows)	<string>,
(last row)	<string>

The data for all graphs can be obtained using one of two commands:

:SENSe:DATA:TELEcom:SMG:HDATA:NORMAL? <numeric>

<numeric> =	-9 to 0	Graphics Store Location
	-10	Disk Storage

Returns a series of numerics (error source bar graph) and 8 bit binary strings (alarm bar graph), separated by commas. All results are returned even if some of those graphs are not applicable to the particular HP configuration at the time the measurement was made.

One complete record is returned for each SMG measurement sample in the selected store location. The position of the data within this record corresponds to the labels obtained using :SENSe:DATA:TELEcom:SMG:LABels? <numeric>

Common Commands

SENSe subsystem - Retrieving Graphics Store Data

:SENSe:DATA:TELEcom:SMG:HDATA:PACKed? <numeric>

<numeric> =	-9 to 0	Graphics Store Location
	-10	Disk Storage

Returns a series of numerics, (Number of unchanged samples, error source bar graph data, alarm bar graph data), separated by commas. All results are returned even if some of those graphs are not applicable to the particular HP configuration at the time the measurement was made.

One complete record is returned for each SMG measurement sample in the selected store location unless the data in consecutive samples is the same. In that case only one record is returned and the first numeric value in each record indicates the number of SMG measurement samples in which the data was unchanged.

The position of the data within this record corresponds to the labels obtained using :SENSe:DATA:TELEcom:SMG:LABels? <numeric>

If an alarm string, whose value is other than "00000000", is returned, this indicates an alarm has occurred. To identify which alarm has occurred obtain the Alarm Labels using:

:SENSe:DATA:TELEcom:SMG:ALABels? <numeric>,<numeric>

<numeric> = (first parameter)	-9 to 0	Graphics Store Location
	-10	Disk Storage
<numeric> = (second parameter)		Graph number

Requests the Alarm labels from the selected SMG store and graph.

Returns:	<numeric>	Number of graph labels being returned
	{<string>}, <string>	List of alphanumeric strings separated by commas. The first label returned corresponds to the most significant bit (MSB) of the alarm string.

SENSe subsystem - Retrieving Data for a Single Graph

SENSe subsystem - Retrieving Data for a Single Graph

The data associated with each individual graph may be obtained using one of the following commands:

:SENSe:DATA:TELEcom:SMG:EDATa? <numeric>,<numeric>

<numeric> = -9 to 0 Graphics Store Location
(first parameter)

 -10 Disk Storage

<numeric> = Graph number
(second parameter)

Returns: <numeric> = 0 to 20,000 Number of events to follow
(first result)

<numeric> = 1 to 86,400,000 Seconds since start of test
(second result)

<numeric> = <numeric> Error Count or Alarm
(third result) Value

Returns the number of events that contributed to the graph, the time elapsed since the start of the graph and the error count or alarm value.

:SENSe:DATA:TELEcom:SMG:VDATa? <numeric>,<numeric>

<numeric> = -9 to 0 Graphics Store Location
(first parameter)

 -10 Disk Storage

<numeric> = Graph number
(second parameter)

Common Commands

SENSe subsystem - Retrieving Data for a Single Graph

Returns:	<numeric> = (first result)	0 to 20,000	Number of events to follow
	<numeric> = (second result)	1 to 2,147,483,647	Seconds since January 1 st 1970
	<numeric> = (third result)	<numeric>	Error Count or Alarm Value

Returns the number of events that contributed to the graph, the time elapsed since January 1st 1970 and the error count or alarm value.

NOTE

PCs calculate time based on January 1st 1970.

:SENSe:DATA:TELEcom:SMG:TINformation? <numeric>,<numeric>

	<numeric> = (first parameter)	-9 to 0	Graphics Store Location
		-10	Disk Storage
	<numeric> = (second parameter)		Graph number
Returns:	<numeric> = (first result)	0 1	Graph not valid Graph valid
	<numeric> = (second result)	0 to 20,000	Number of events to follow
	<numeric> = (third result)	ALAR HIST	Alarm Bar Graph Error Source Bar Graph

Returns the validity of the graph, the number of events that have contributed to the graph and the type of graph.

SENSe subsystem -Obtaining Graphics End of Measurement Results

:SENSe:DATA:TELEcom:SMG:DATA? <numeric>,<string>

<numeric> = (first parameter)	-9 to 0	Graphics Store Location
	-10	Disk Storage
<numeric> = (second parameter - result selection)	<"ECOunt:PDH:BIT">	UPDH bit error count
	<"ECOunt:PDH:CODE">	UPDH code error count
	<"ECOunt:PDH:FAS">	UPDH FAS error count
	<"ECOunt:PDH:CRC">	UPDH CRC error count
	<"ECOunt:PDH:REBE">	UPDH FAS REBE count
	<"ERATio:PDH:BIT">	UPDH bit error ratio
	<"ERATio:PDH:CODE">	UPDH code error ratio
	<"ERATio:PDH:FAS">	UPDH FAS error ratio
	<"ERATio:PDH:CRC">	UPDH CRC error ratio
	<"ERATio:PDH:REBE">	UPDH REBE error ratio
	<"ASECnds:PDH:LOS">	UPDH Loss of Signal seconds
	<"ASECnds:PWL">	Power Loss seconds
	<"ASECnds:PDH:LOF">	UPDH Loss of frame seconds
	<"ASECnds:PDH:MFM">	UPDH M'frame loss seconds
	<"ASECnds:PDH:AIS">	UPDH AIS seconds
	<"ASECnds:PDH:RAI">	UPDH Remote loss seconds
	<"ASECnds:PDH:RMFR">	UPDH Remote m'frame loss seconds
	<"ASECnds:PDH:PSL">	UPDH Pattern sync loss seconds
	<"ECOunt:SPDH:BIT">	SPDH bit error count

Common Commands

SENSE subsystem -Obtaining Graphics End of Measurement Results

<"ECOunt:SPDH:CODE">	SPDH code error count
<"ECOunt:SPDH:M2:FAS">	SPDH 2 Mb/s FAS error count
<"ECOunt:SPDH:M8:FAS">	SPDH 8 Mb/s FAS error count
<"ECOunt:SPDH:M34:FAS">	SPDH 34 Mb/s FAS error count
<"ECOunt:SPDH:M140:FAS">	SPDH 140 Mb/s FAS error count
<"ECOunt:SPDH:PBITs">	SPDH P Parity error count
<"ECOunt:SPDH:CPBits">	SPDH CP Parity error count
<"ECOunt:SPDH:DS3:FAS">	SPDH DS3 FAS error count
<"ECOunt:SPDH:DS1:FAS">	SPDH DS1 FAS error count
<"ECOunt:SPDH:CRC">	SPDH CRC6 error count
<"ECOunt:SPDH:REBE">	SPDH FAS REBE error count
<"ECOunt:SPDH:FEBE">	DS3 FEBE error count
<"ERATio:SPDH:BIT">	SPDH bit error ratio
<"ERATio:SPDH:CODE">	SPDH code error ratio
<"ERATio:SPDH:M2:FAS">	SPDH 2 Mb/s FAS error ratio
<"ERATio:SPDH:M8:FAS">	SPDH 8 Mb/s FAS error ratio
<"ERATio:SPDH:M34:FAS">	SPDH 34 Mb/s FAS error ratio
<"ERATio:SPDH:M140:FAS">	SPDH 140 Mb/s FAS error ratio
<"ERATio:SPDH:PBITs">	SPDH P Parity error ratio
<"ERATio:SPDH:CPBits">	SPDH CP Parity error ratio
<"ERATio:SPDH:DS3:FAS">	SPDH DS3 FAS error ratio
<"ERATio:SPDH:DS1:FAS">	SPDH DS1 FAS error ratio
<"ERATio:SPDH:CRC">	SPDH CRC error ratio
<"ERATio:SPDH:REBE">	SPDH REBE error ratio
<"ERATio:SPDH:FEBE">	DS3 FEBE error ratio
<"ASEConds:SPDH:LOS">	Loss of Signal seconds
<"ASEConds:SPDH:M2:LOF">	Loss of frame seconds 2 Mb/s
<"ASEConds:SPDH:M8:LOF">	Loss of frame seconds 8 Mb/s

Common Commands

SENSe subsystem -Obtaining Graphics End of Measurement Results

<"ASEConds:SPDH:M34:LOF">	Loss of frame seconds 34 Mb/s
<"ASEConds:SPDH:M140:LOF">	Loss of frame seconds 140 Mb/s
<"ASEConds:SPDH:DS1:OOF">	Out of frame seconds DS1
<"ASEConds:SPDH:DS3:OOF">	Out of frame seconds DS3
<"ASEConds:SPDH:DS3:EXZ">	DS3 Excess zeros
<"ASEConds:SPDH:DS1:EXZ">	DS1 Excess zeros
<"ASEConds:SPDH:DS3:IDLE">	DS3 Idle
<"ASEConds:SPDH:MFM">	M'frame loss seconds
<"ASEConds:SPDH:AIS">	AIS seconds
<"ASEConds:SPDH:RAI">	Remote loss seconds
<"ASEConds:SPDH:RMFR">	Remote m'frame loss seconds
<"ASEConds:SPDH:PSL">	Pattern sync loss seconds
<"TR1:SPDH:TRANsmit:ANALysis:M2120">	15 minute TX threshold report
<"TR1:SPDH:RECeive:ANALysis:M2120">	15 minute RX threshold report
<"TR2:SPDH:TRANsmit:ANALysis:M2120">	24 hour TX threshold report
<"TR2:SPDH:RECeive:ANALysis:M2120">	24 hour RX threshold report
<"ECOunt:SDH:FRAME">	SDH Frame error count
<"ECOunt:SDH:RSBip">	B1 RS BIP error count
<"ECOunt:SDH:MSBip">	MS B2 BIP error count
<"ECOunt:SDH:MFEBe"> or <"ECOunt:SDH:MSRei">	MS FEBE/MS REI error count
<"ECOunt:SDH:PBIP">	Path B3 BIP error count
<"ECOunt:SDH:FEBE"> or <"ECOunt:SDH:REI">	Path FEBE/HP-REI error count
<"ECOunt:SDH:PIEC">	Path IEC error count

Common Commands

SENSE subsystem -Obtaining Graphics End of Measurement Results

<"ECOunt:SDH:TRIB:FEBe"> or <"ECOunt:SDH:TRIB:REI">	TU FEBe/LP-REI error count
<"ECOunt:SDH:TRIB:PBIP">	TU path BIP error count
<"ERATio:SDH:FRAMe">	SDH Frame error ratio
<"ERATio:SDH:RSBip">	B1 RS BIP error ratio
<"ERATio:SDH:MSBip">	MS B2 BIP error ratio
<"ERATio:SDH:MFEBe"> or <"ERATio:SDH:MSRei">	MS FEBe/RS-REI error ratio
<"ERATio:SDH:PBIP">	Path B3 BIP error ratio
<"ERATio:SDH:FEBe"> or <"ERATio:SDH:FEBe">	Path FEBe/HP-REI error ratio
<"ERATio:SDH:PIEC">	Path IEC error ratio
<"ERATio:SDH:TRIB:FEBe"> or <"ERATio:SDH:TRIB:REI">	TU FEBe/LP-REI error ratio
<"ERATio:SDH:TRIB:PBIP">	TU path BIP error ratio
"PACTivity:SDH:NDFSeconds"	AU Pointer NDF seconds
"PACTivity:SDH:MNDFseconds"	AU Pointer MNDF seconds
"PACTivity:SDH:PCOunt"	AU Pointer +ve Adj Count
"PACTivity:SDH:NCOunt"	AU Pointer -ve Adj Count
"PACTivity:SDH:TRIButary:NDFSec onds"	TU Pointer NDF seconds
"PACTivity:SDH:TRIButary:MNDFse conds"	TU Pointer MNDF seconds
"PACTivity:SDH:TRIButary:PCOunt"	TU Pointer +ve Adj Count
"PACTivity:SDH:TRIButary:NCOunt"	TU Pointer -ve Adj Count
<"ASEConds:SDH:PLOSs">	Power loss seconds
<"ASEConds:SDH:LOS">	Loss of signal seconds
<"ASEConds:SDH:LOF">	Loss of frame seconds
<"ASEConds:SDH:OOF">	Out of frame seconds
<"ASEConds:SDH:H4MF">	H4 multiframe loss seconds

Common Commands

SENSE subsystem -Obtaining Graphics End of Measurement Results

<"ASECnds:SDH:LOP">	Loss of pointer seconds
<"ASECnds:SDH:MSAis">	MS AIS seconds
<"ASECnds:SDH:PAIS">	Path AIS seconds
<"ASECnds:SDH:PSLoss">	Pattern Sync Loss seconds
<"ASECnds:SDH:MSFerf"> or <"ASECnds:SDH:MSRDi">	MS FERF/MS-RDI seconds
<"ASECnds:SDH:K1K2">	K1K2 change seconds
<"ASECnds:SDH:PFERf"> or <"ASECnds:SDH:RDI">	STM Path FERF/HP-RDI seconds
<"ASECnds:SDH:OPSL">	Overhead Pattern Sync Loss
<"ASECnds:SDH:TRIB:LOP">	TU Loss of pointer seconds
<"ASECnds:SDH:TRIB:PAIS">	TU Path AIS seconds
<"ASECnds:SDH:TRIB:PFERf"> or <"ASECnds:SDH:TRIB:RDI">	TU Path FERF/LP-RDI seconds
<"ECOunt:SONet:FRAMe">	SONET Frame error count
<"ECOunt:SONet:CVS">	CV-S (Section B1 BIP) error count
<"ECOunt:SONet:CVL">	CV-L (Section B2 BIP) error count
<"ECOunt:SONet:REIL">	REI-L (Line FEBE) error count
<"ECOunt:SONet:CVP">	CV-P (Path B3 BIP) error count
<"ECOunt:SONet:REIP">	REI-P (Path FEBE) error count
<"ECOunt:SONet:CVIec">	CV-IEC error count
<"ECOunt:SONet:TRIB:REIV">	REI-V (VT FEBE) error count
<"ECOunt:SONet:TRIB:CVV">	CV-V (VT path BIP) error count
<"ERATio:SONet:FRAMe">	SONET Frame error ratio
<"ERATio:SONet:CVS">	CV-S (Section B1 BIP) error ratio
<"ERATio:SONet:CVL">	CV-L (Line B2 BIP) error ratio
<"ERATio:SONet:REIL">	REI-L (Line FEBE) error ratio
<"ERATio:SONet:CVP">	CV-P (Path B3 BIP) error ratio
<"ERATio:SONet:REIP">	REI-P (Path FEBE) error ratio

Common Commands

SENSE subsystem -Obtaining Graphics End of Measurement Results

<"ERATio:SONet:CVIec">	CV-IEC error ratio
<"ERATio:SONet:TRIB:REIV">	REI-V (VT FEBE) error ratio
<"ERATio:SONet:TRIB:CVV">	CV-V (VT path BIP) error ratio
"PACTivity:SONet:NDFSeconds"	SPE Pointer NDF seconds
"PACTivity:SONet:MNDFseconds"	SPE Pointer MNDF seconds
"PACTivity:SONet:PCOunt"	SPE Pointer +ve Adj Count
"PACTivity:SONet:NCOunt"	SPE Pointer -ve Adj Count
"PACTivity:SONet:TRIButary:NDFS econds"	VT Pointer NDF seconds
"PACTivity:SONet:TRIButary:MNDF seconds"	VT Pointer MNDF seconds
"PACTivity:SONet:TRIButary:PCOu nt"	VT Pointer +ve Adj Count
"PACTivity:SONet:TRIButary:NCOu nt"	VT Pointer -ve Adj Count
<"ASEConds:SONet:PLOSs">	Power loss seconds
<"ASEConds:SONet:LOS">	Loss of signal seconds
<"ASEConds:SONet:LOF">	Loss of frame seconds
<"ASEConds:SONet:SEF">	Severely Errored Frame Defect seconds
<"ASEConds:SONet:H4MF">	H4 multiframe loss seconds
<"ASEConds:SONet:LOPP">	LOP-P (Loss of pointer) seconds
<"ASEConds:SONet:AISL">	AIS-L (Line AIS) seconds
<"ASEConds:SONet:AISP">	AIS-P (Path AIS) seconds
<"ASEConds:SONet:PSLoss">	Pattern Sync Loss seconds
<"ASEConds:SONet:RDIL">	RDI-L (Line FERF) seconds
<"ASEConds:SONet:K1K2">	K1K2 change seconds
<"ASEConds:SONet:RDIP">	RDI-P (Path FERF) seconds
<"ASEConds:SONet:OPSL">	Overhead Pattern Sync Loss
<"ASEConds:SONet:TRIB:LOPV">	LOP-V (VT Loss of pointer) seconds

Common Commands

SENSE subsystem -Obtaining Graphics End of Measurement Results

<"ASEConds:SONet:TRIB:AISV">	AIS-V (VT Path AIS) seconds
<"ASEConds:SONet:TRIB:RDIV">	RDI-V (VT Path FERF) seconds
<"COUNt:JITT:HITS">	Jitter Hit count
<"SLIPs:JITT:WANDer:FRAMe">	estimated frame slips
<"SLIPs:JITT:WANDer:BIT">	estimated bit slips
<"ECOunt:ATM:EMBip">	EM BIP count
<"ECOunt:ATM:FEBE"> or <"ECOunt:ATM:REI">	FEBE/REI count
<"ECOunt:ATM:CHEC">	Corrected HEC count
<"ECOunt:ATM:NCHeC">	Non Corrected HEC count
<"ECOunt:ATM:BIT">	Cell Bit count
<"ECOunt:ATM:LCELI">	Cell loss count
<"ECOunt:ATM:NCCell">	Non Conforming Cell count
<"ECOunt:ATM:RCELI">	Received cell count
<"ECOunt:ATM:MCELI">	Misinserted cell count
<"ECOunt:ATM:ECELI">	Errored cell count
<"ECOunt:ATM:CRC4">	CRC4 Error count
<"ECOunt:ATM:REBE">	REBE Error count
<"ECOunt:ATM:BEDC">	BEDC Error count
<"ECOunt:ATM:PLCP:BIP">	DS3 PLCP BIP error count
<"ECOunt:ATM:PLCP:FEBE">	DS3 PLCP FEBE error count
<"ECOunt:ATM:PLCP:TRailer">	DS3 PLCP Trailer error count
<"ERATio:ATM:EMBip">	EM BIP ratio
<"ERATio:ATM:FEBE"> or <"ERATio:ATM:REI">	FEBE/REI ratio
<"ERATio:ATM:CHEC">	Corrected HEC ratio
<"ERATio:ATM:NCHeC">	Non Corrected HEC ratio
<"ERATio:ATM:BIT">	Cell Bit ratio
<"ERATio:ATM:LCELI">	Cell loss ratio

Common Commands

SENSE subsystem -Obtaining Graphics End of Measurement Results

<"ERATio:ATM:NCCell">	Non Conforming Cell ratio
<"ERATio:ATM:RCELI">	Received cell rate
<"ERATio:ATM:MCELI">	Misinserted cell rate
<"ERATio:ATM:ECELI">	Errored cell ratio
<"ERATio:ATM:CRC4">	CRC4 Error ratio
<"ERATio:ATM:REBE">	REBE Error ratio
<"ERATio:ATM:BEDC">	BEDC Error ratio
<"ERATio:ATM:PLCP:BIP">	DS3 PLCP BIP Error ratio
<"ERATio:ATM:PLCP:FEBE">	DS3 PLCP FEBE Error ratio
<"ERATio:ATM:PLCP:TRAIler">	DS3 PLCP Trailer Error ratio
<"ASEConds:ATM:PSLoss">	Pattern loss seconds
<"ASEConds:ATM:CSLoss">	Cell sync loss seconds
<"ASEConds:ATM:SCNReceived">	Selected cell not received seconds
<"ASEConds:ATM:CEXPerienced">	Congestion experienced seconds
<"ASEConds:ATM:VPAis">	Virtual Path AIS seconds
<"ASEConds:ATM:VPFerf"> or <"ASEConds:ATM:VPRDi">	Virtual Path FERF/RDI seconds
<"ASEConds:ATM:VPLoc">	Virtual Path Loss of continuity seconds
<"ASEConds:ATM:VCAis">	Virtual Channel AIS seconds
<"ASEConds:ATM:VCFerf"> or <"ASEConds:ATM:VCRDi">	Virtual Channel FERF/RDI seconds
<"ASEConds:ATM:VCLoc">	Virtual Channel Loss of continuity seconds
<"ASEConds:ATM:TCLoss">	Test Cell loss seconds
<"ASEConds:ATM:LPM">	Performance Management OAM loss seconds
<"ASEConds:ATM:PLCP:OOF">	DS3 PLCP Out of frame
<"ASEConds:ATM:PLCP:RAI">	DS3 PLCP Remote Alarm Indication
ECOUNT:ATM:AAL1:RCELI	Cumulative cell (AAL1 PDU) count

Common Commands

SENSE subsystem -Obtaining Graphics End of Measurement Results

ECOUNT:ATM:AAL1:LCELL	Cumulative lost cell count
ECOUNT:ATM:AAL1:NCCRC	Cumulative non-corr seq no prot code error
ECOUNT:ATM:AAL1:CCRC	Cumulative corrected seq num prot code error
ECOUNT:ATM:AAL3:RCELL	Cumulative cell (AAL3 PDU) count
ECOUNT:ATM:AAL3:CRC	Cumulative CRC10 error count
ECOUNT:ATM:AAL3:STYPE	Cumulative CRC10 error count
ECOUNT:ATM:AAL3:RPDU	Cumulative CPCS PDU count
ECOUNT:ATM:AAL3:ABORT	Cumulative ABORT SAR PDU count
ECOUNT:ATM:AAL5:CRC	Cumulative CRC32 error count
ECOUNT:ATM:AAL5:CRC	Cumulative length error count
ECOUNT:ATM:AAL5:RPDU	Cumulative AAL5 CPCS PDU count
ECOUNT:ATM:AAL5:ABORT	Cumulative ABORT CPCS PDU count
ECOUNT:ATM:AAL5:ABORT	Cumulative ABORT CPCS PDU count
ECOUNT:ATM:AAL5:LOVerrun	Cumulative overrun (>65536 ocets) count
ERATIO:ATM:AAL1:NCCRC	Cumulative Non-corr SNP code error ratio
ERATIO:ATM:AAL1:CCRC	Cumulative corr SNP code error ratio
ERATIO:ATM:AAL3:CRC	Cumulative CRC10 error ratio
ERATIO:ATM:AAL5:CRC	Cumulative CRC32 error ratio
ASECONDS:ATM:AAL:AALLoss	AAL Loss alarm seconds count

STATus subsystem

STATus subsystem

This subsystem controls the status reporting registers. SCPI defined status registers QUEStionable, OPERation and INSTRument are provided. In addition instrument defined status registers DATA, UPDH, FAS, SPDH, SDH, SDH2, SON, SON2, JITT and ATM are provided. For detailed information on status reporting refer to Section 8 of this manual.

:STATus:CHIStory

Clear the contents of all History registers, and the front panel led history.

:STATus:PRESet

Sets all Status registers to the default state as defined in Appendix A, *Default Settings*.

Common Commands

STATus subsystem

For each of the **<Status Registers>**'s listed in Table 8-1 (excluding the Standard Event Register) the following commands exist.

:STATus:<Status Register>:ENABle <numeric>

Sets the Event Enable register mask which allows true conditions in the Event register to be reported in the **<Status Register>**'s summary bit. If a bit is 1 in the Event Enable register and its associated event bit makes the transition to true, a positive transition will occur in the **<Status Register>**'s summary bit.

The corresponding query returns the current mask setting.

:STATus:<Status Register>:ENABle?

Returns : <numeric>

:STATus:<Status Register>:PTRansition <numeric>

Sets the positive Transition Filter. Setting a bit in the positive Transition filter shall cause a 0 to 1 transition in the corresponding bit of the **<Status Register>**'s Condition register to cause a 1 to be written in the corresponding bit of the **<Status Register>**'s Event register.

The corresponding query returns the current setting.

:STATus:<Status Register>:PTRansition?

Returns : <numeric>

:STATus:<Status Register>:NTRansition <numeric>

Sets the negative Transition filter. Setting a bit in the negative Transition Filter shall cause a 1 to 0 transition in the corresponding bit of the **<Status Register>**'s Condition register to cause a 1 to be written in the corresponding bit of the **<Status Register>**'s Event register.

The corresponding query returns the current setting.

:STATus:<Status Register>:NTRansition?

Returns : <numeric>

:STATus:<Status Register>:EVENT?

Returns : <numeric>

Common Commands

STATus subsystem

Returns the contents of the Event register associated with the <Status Register>. Reading this register clears its contents.

:STATus:<Status Register>:CONDition?

Returns : <numeric>

Returns the contents of the Condition register associated with the <Status Register>. Reading this register does not clear its contents.

:STATus:<Status Register>:HISTory?

Returns : <numeric>

Returns the contents of the History register associated with the <Status Register>. This is in effect a latched version of the Condition register. A bit set to 1 in the Condition register will set the corresponding bit in the History register. This register is not cleared when it is read. The only time the History register is cleared is at a start of test, when **RESET HISTORY** is pressed or when the commands *RST or :STATus:CHIStory are sent.

SYSTEM Subsystem

SYSTEM Subsystem

:SYSTEM:WINDOW<type>

Selects the display type, Single or Multiple. Selection of SINGLE results in faster remote operation.

<type> =	SINGLE	Selects single window display
	MULTIPLE	Selects multiple window display

The corresponding query returns the display type.

:SYSTEM:WINDOW?

Returns : <type>

:SYSTEM:DATE <year>,<month>,<day>

<year> =	<numeric>	1970 to 2069
<month> =	<numeric>	1 to 12
<day> =	<numeric>	1 to 31

Sets the date within the OTHER TIME & DATE function.

The corresponding query returns the date in numeric form.

:SYSTEM:DATE?

Returns : <year>,<month>,<day>

:SYSTEM:TIME <hour>,<minute>,<second>

<hour> =	<numeric>	0 to 23
<minute> =	<numeric>	0 to 59
<second> =	<numeric>	0 to 59

Sets the time within the OTHER TIME & DATE function.

Common Commands

SYSTem Subsystem

The corresponding query returns the time in numeric form.

:SYSTem:TIME?

Returns : <hour>,<minute>,<second>

:SYSTem:KLOCK <boolean>

<boolean> =	0 or OFF	Keyboard unlocked
	1 or ON	Keyboard locked

Selects the state of the OTHER KEYBOARD LOCK function.

The corresponding query returns the state of KEYBOARD LOCK as 0 or 1.

:SYSTem:KLOCK?

Returns : <numeric> 0 or 1

:SYSTem:LOCal

Set the HP 37717C to Local (keyboard) control.

:SYSTem:REMOte

Set the HP 37717C to Remote control.

:SYSTem:PRESet

Sets the instrument to the same state as the front panel reset key (power). This command is similar to *RST but differs in that it duplicates the action of the front panel power on/off key.

:SYSTem:SERial?

The serial number is returned as a string in the form "GBnnnnnnnn". GB signifies the country of origin (Great Britain).

:SYSTem:CONF <block>

<block> = #0 type Block

Sets the HP 37717C to the state defined by the Block data.

The corresponding query returns the instrument state in block form.

Common Commands

SYSTem Subsystem

:SYSTem:CONF?

Returns : #0<block>

:SYSTem:VERSion?

Requests the revision state of the SCPI remote control.

The revision state is returned in the form YYYY.V. YYYY signifies the year and V signifies the revision number.

Returns : <version> = YYYY.V

:SYSTem:ERRor?

Requests the HP 37717C remote control Error status.

The error status is returned as a numeric value and a string containing a description of the error.

Returns : <numeric>,<string>

:SYSTem:PRINt

The current results are logged to the selected printer.

:SYSTem:PRINt:AUTO <boolean>

<boolean> = 0 or OFF
1 or ON

Determines whether the selected results are logged to the selected logging device. If OFF is selected results can only be logged using :SYSTem:PRINt. If ON is selected further selection of :SYSTem:PRINt:PERiod <period> is required.

The corresponding query returns the logging state as 0 or 1.

:SYSTem:PRINt:AUTO?

Returns : 0 or 1

:SYSTem:PRINt:PERiod <period>

<period> = OFF Log at end of test

Common Commands

SYSTem Subsystem

MIN10	Log at 10 minute intervals
HR1	Log at 1 hour intervals
HR24	Log at 24 hour intervals
NEST	Nested Logging (PDH Only)
USER	User defined Logging interval

Determines the interval at which the results are logged to the selected logging device. If anything other than OFF is selected further selection of :SYSTem:PRINt:RESults <type> is required. If USER is selected further selection of :SYSTem:PRINt:UPERiod <numeric>,<discrete> is required.

The corresponding query returns the logging interval in discrete form, as listed above.

:SYSTem:PRINt:PERiod?

Returns : <period>

:SYSTem:PRINt:UPERiod <numeric>,<discrete>

<numeric> = 1 to 99

<discrete> = HR Hours (1 - 99)

MIN Minutes (10 - 99)

Sets the USER defined logging period in the range 10 to 99 minutes or 1 to 99 hours.

The corresponding query returns the User defined period in numeric, discrete form, as listed above.

:SYSTem:PRINt:UPERiod?

Returns : <numeric>,<discrete>

:SYSTem:PRINt:RESults <type>

<type> = ALL Print All results

SELEct Print selected results

Determines which results are logged to the selected logging device. If SEL is selected further selections of :SYSTem:PRINt:CONTent <content> ,

Common Commands

SYSTem Subsystem

:SYSTem:PRINt:WHEN <select> and :SYSTem:PRINt:SPAN <content> are required.

The corresponding query returns the logged results selection in discrete form, as listed above.

:SYSTem:PRINt:RESults?

Returns : <type>

:SYSTem:PRINt:CONtEnt <content>

<content> =	ERATio	Error Ratio results
	ANALysis	Analysis results
	BOTH	Error Ratio & Analysis results

In conjunction with ::SYSTem:PRINt:SPAN <content> determines the type of selected results to be logged to the selected logging device.

The corresponding query returns the result content in discrete form, as listed above.

:SYSTem:PRINt:CONtEnt?

Returns : <content>

:SYSTem:PRINt:SPAN <content>

<content> =	PERiod	Period results
	CUMulative	Cumulative results
	BOTH	Period & Cumulative results

In conjunction with ::SYSTem:PRINt:CONtEnt <content> determines the type of selected results to be logged to the selected logging device.

Common Commands

SYSTem Subsystem

The corresponding query returns the result content in discrete form, as listed above.

:SYSTem:PRINt:SPAN?

Returns : <content>

:SYSTem:PRINt:WHEN <select>

<select> =	ALWays	Logged at specified interval
	ECOut	Logged if bit error count is > 0

Determines the conditions for logging results when :SYSTem:PRINt:RESults <type> is set to <SEL>.

The corresponding query returns the logging conditions in discrete form, as listed above.

:SYSTem:PRINt:WHEN?

Returns : <select>

:SYSTem:PRINt:MODE <mode>

<mode> =	NORMAl	Normal print format
	COMPRESSED	Compressed print format

Only valid when RS232 or Parallel printer is selected. Determines the column width of the printed results.

The corresponding query returns the print mode in discrete form, as listed above.

:SYSTem:PRINt:MODE?

Returns : <mode>

:SYSTem:PRINt:ESEConds <boolean>

<boolean> =	0 or OFF
	1 or ON

Determines whether occurrences of error seconds are logged on the selected logging device.

Common Commands

SYSTEM Subsystem

The corresponding query returns the error second logging state as 0 or 1.

:SYSTEM:PRINT:ESECONDS?

Returns : <boolean>

:SYSTEM:LOGGING:DEVICE <type>

<type> =	INTERNAL	Internal printer
	HPIB	HPIB external printer
	RS232	RS-232-C external printer
	DISK	Internal Disc Drive
	PARALLEL	Centronics external printer

Selects the logging device for results logging.

The corresponding query returns the logging device selected in discrete form as listed above.

:SYSTEM:LOGGING:DEVICE?

Returns : <type>

:SYSTEM:PRINT:DEMAND:MODE <mode>

<mode> =	RESULTS	Print results snapshot
	OVERHEAD	Print overhead snapshot
	OCAPTURE	Print overhead capture results
	PGRAPH	Print pointer graph
	TRIBSCAN	Print SDH/SONET tributary scan
	SDUMP	Copies the current display to the internal disc drive
	ALMSCAN	Print alarm scan information

Option A1T, A3R only. Selects the Log on Demand item to be printed.

The corresponding query returns the log on demand item selected in discrete short form.

Common Commands

SYSTEM Subsystem

:SYSTEM:PRINT:DEMAND?

Returns: <mode>

:SYSTEM:DISK:FORMAT

Format a Disk.

:SYSTEM:DISK:Label <string>

Label the disk with a string of up to 11 alphanumeric characters e.g. "SiteB 28/5"

The corresponding query returns the filename as a string.

:SYSTEM:DISK:Label?

Returns : <string>

:SYSTEM:DISK:SAVE <extension>,<filename>,<overwrite>

<extension> =	CNF	Instrument Configuration
	SMG	Stored Measurement Graphics
	PRN	Data Logging

<filename> = Up to 8 Alphanumeric character string

<overwrite> =	0	If file exists will not overwrite
	1	Will overwrite automatically

Saves required information to disk. If PRN is selected further selection of :SYSTEM:DISK:SAVE:MODE <discrete> is required.

:SYSTEM:DISK:SAVE:MODE <discrete>

<discrete> =	APPend	Add to file
	OVERwrite	Overwrite existing file

Designates the position within the file to which the results are saved if the file type is PRN.

The corresponding query returns the save mode in discrete form as listed above.

:SYSTEM:DISK:SAVE:MODE?

Common Commands

SYSTEM Subsystem

Returns : <discrete>

:SYSTEM:DISK:RECall <extension>,<filename>,<confirm>

<extension> =	CNF	Instrument Configuration
	SMG	Stored Measurement Graphics

<filename> = Up to 8 Alphanumeric character string

<confirm> = 0 If Option structure is different from stored configuration will not recall.
1 Will recall stored configuration automatically.

Recalls stored measurement graphics or instrument configuration from Disk to instrument.

:SYSTEM:DISK:FILE;COPY:CNF

<to>,<store>,<directory>,<filename>,<overwrite>

<to> =	DISK	Copy to Disk
	MEMory	Copy to Instrument store
<store> =	1 to 4	Instrument store number

<directory> = Up to 256 Alphanumeric character string

<filename> = Up to 8 Alphanumeric character string

<overwrite> = 0 **Copying to Disk:** If file exists will not overwrite.
Copying to Instrument: If Option structure is different from stored configuration will not copy.
1 **Copying to Disk:** Will copy automatically.
Copying to Instrument: Will copy automatically.

Common Commands

SYSTEM Subsystem

Copy instrument configuration from Disk to instrument store or from instrument store to Disk. When TO = MEMORY OVERWRITE must be 1.

:SYSTEM:DISK:FILE:COPY:SMG:FORMat <type>

<type> =	NORMAL	Normal SMG format
	CSV	Comma Separated Variable

Sets the format of the SMG data to be copied to Disk. This should be set before the :SYSTEM:DISK:FILE:COPY:SMG command is issued.

:SYSTEM:DISK:FILE:COPY:SMG:FORMat?

Returns : <discrete>

:SYSTEM:DISK:FILE:COPY:SMG

<store>,<directory>,<filename>,<overwrite>

<store> = -9 to 0 Instrument store number

<directory> = Up to 256 Alphanumeric character string

<filename> = Up to 8 Alphanumeric character string

<overwrite> = 0 If file exists will not overwrite

1 Will overwrite automatically

Copy stored measurement graphics from instrument store to Disk. Set :SYSTEM:DISK:FILE:COPY:SMG:FORMat <type> to NORM or CSV before issuing this command.

:SYSTEM:DISK:FILE:DELEte <filename>

<filename> = Up to 12 Alphanumeric character string including extension

:SYSTEM:DISK:DIRectory:DELEte

Delete current directory.

Common Commands

SYSTEM Subsystem

:SYSTEM:DISK:FILE:REName <from_filename>,<to_dir>, <filename>,
<overwrite>

<from_filename> = Up to 12 Alphanumeric character string including extension

<to_dir> = Up to 256 Alphanumeric character string

<to_filename> = Up to 12 Alphanumeric character string including extension

<overwrite> = 0 If file exists will not overwrite

1 Will overwrite automatically

Rename file. Cannot rename directories.

:SYSTEM:DISK:DIRectory:CREate <filename>

<filename> Up to 8 Alphanumeric character string

Create a directory.

:SYSTEM:DISK:DIRectory? <extension>,<format>

<extension> = ALL List all files

CNF List only files with CNF extension

SMG List only files with SMG extension

PRN List only files with PRN extension

<format> = SHORT List file name only

LONG List file name, file size, date & time modified

DESCRiption list file name, file description

Returns directory list.

:SYSTEM:DISK:PWD?

Returns : <string>

Returns directory name.

Common Commands

SYSTEM Subsystem

:SYSTEM:DISK:FREE?

Returns : <numeric>

Returns free space on disk in bytes.

:SYSTEM:DISK:CD <string>

<directory> =	"dir_name"	Up to 8 alphanumeric characters
	".."	CD to parent directory
	"\"	CD to root directory

Change directory.

:SYSTEM:COMMunicate:SERial:BAUD <rate>

<rate> =	300
	600
	1200
	1800
	2400
	4800
	9600

Determines the speed (Baud Rate) at which the RS-232-C remote control and printer interface operates.

The corresponding query returns the Baud Rate in numeric form as listed above.

:SYSTEM:COMMunicate:SERial:BAUD?

Returns : <rate>

:SYSTEM:COMMunicate:SERial:MODE <type>

<type> =	COMPUter	RS-232-C computer control
	TERMIal	RS-232-C terminal control

Determines the type of controller to be used on the RS-232-C remote control interface.

Common Commands

SYSTEM Subsystem

The corresponding query returns the type of controller in discrete form as listed above.

:SYSTEM:COMMunicate:SERial:MODE?

Returns : <type>

:SYSTEM:COMMunicate:SERial:PARity <type>

<type> = ODD
EVEN
ZERO
ONE

Determines the type of parity to be used on the RS-232-C remote control interface. The corresponding query returns the type of parity in discrete form as listed above.

:SYSTEM:COMMunicate:SERial:PARity?

Returns : <type>

:SYSTEM:COMMunicate:SERial:SBITs <numeric>

<numeric> = 1 One stop bit
2 Two stop bits

Determines the number of stop bits used on the RS-232-C remote control interface. The corresponding query returns the number of stop bits in numeric form as listed above.

:SYSTEM:COMMunicate:SERial:SBITs?

Returns : <numeric>

:SYSTEM:COMMunicate:SERial:XON <type>

<type> = OFF
RXTX Receive and Transmit

Determines the Xon/Xoff setting used on the RS-232-C remote control interface.

Common Commands

SYSTEM Subsystem

The corresponding query returns the Xon/Xoff setting in discrete form as listed above.

:SYSTEM:COMMunicate:SERial:XON?

Returns : <type>

:SYSTEM:SSETting:LOCK <boolean>

<boolean> =	0 or OFF	Lock Off
	1 or ON	Lock On

Selects the state of OTHER Stored Settings lock.

The corresponding query returns the state of Stored Settings lock as 0 or 1.

:SYSTEM:SSETting:LOCK?

Returns : <boolean>

:SYSTEM:SSETting:LABel <numeric>,<title>

<numeric> =	1 to 9	Stored Setting number
<title> =	String	1 to 24 ASCII characters

Titles the Store Setting location with the contents of the string.

The corresponding query returns the title of the selected Stored Setting location as a string.

:SYSTEM:SSETting:LABel? <numeric>

Returns : <string> 1 to 24 ASCII characters

:SYSTEM:BEEPer:STATe <boolean>

<boolean> =	0 or OFF	Beep Off
	1 or ON	Beep On

Selects the state of the OTHER BEEP ON ERROR function.

Common Commands

SYSTem Subsystem

The corresponding query returns the state of the BEEP ON ERROR function as 0 or 1.

:SYSTem:BEEPer:STATe?

Returns : <boolean>

:SYSTem:TELEcom:PDH:MODE <discrete>

<discrete> = OUTService Out of Service testing
 INService In Service testing

Selects the testing mode. OUTS (TX and RX) or INS monitoring (RX only).

The corresponding query returns the testing mode in discrete form, as listed above.

:SYSTem:TELEcom:PDH:MODE?

Returns : <discrete>

Common Commands
IEEE common capabilities

IEEE common capabilities

***CLS**

Clear Status - Clears all status registers and the error queue.

***ESE <numeric>**

Event Status Enable - Sets the mask of the Event Status Register.

<numeric> =	1	Operation Complete
	2	Request Control
	4	Query Error
	8	Device Dependent Error
	16	Execution Error
	32	Command Error
	64	User Request
	128	Power On

***ESE?**

Event Status Enable Query - Returns the current mask setting.

***ESR?**

Event Status Register Query - Returns the state of the Event Status Register in numeric form.

***IDN?**

Identification Query - Returns the Manufacture Name, Model Number & Name, Serial Number, Firmware Revision Number as a string :

"HEWLETT-PACKARD, COMMUNICATIONS PERFORMANCE ANALYZER, GBnnnnnnnn, A.nn.nn" GB signifies the country of origin (Great Britain).

***LRN?**

Learn Query - Returns the instrument settings configuration in <#0 Block> form.

Common Commands
IEEE common capabilities

***OPC**

Operation Complete - Masks the OPC bit in the Event Status Register.

***OPC?**

Operation Complete Query - Returns a 1 when the OPC bit in the Event Status Register is set to 1 (true).

***OPT?**

Option Identification Query - Returns the Option and Plug-in state of the instrument
 :

Option/Plug-In Fitted	Returned Result
None	0
Unstructured PDH	UKK
Structured PDH	UKJ
G.707 ANSI/ETSI Payloads	110
G.707 SONET Mappings	120
Rx Only Structured PDH	UKL
PDH Binary Interfaces	UH3
SDH + Frequency Offset + Alarm/Error Generation	US1
SDH + Frequency Offset + Overhead Access	A1T
SDH + Frequency Offset + Overhead Access + STM-0	A3R
STM-0/STM-1/STM-4 Optical Interface 1310/1550 nm	130
STM-0/STM-1/STM-4 Optical Interface 1310 nm	131
STM-0/STM-1/STM-4 Binary Interfaces	0YH
STM-1 Optical Interface	UH1
STM-1/STM-4 Optical Interface 1310 nm	UH2
STM-1/STM-4 Optical Interface 1550 nm	URU
STM-1/STM-4 Optical Interface 1310/1550 nm	USN
STM-1/STM-4 Optical Interface 1310 nm	UKT
ATM Cell Level	UKN
ATM Services	USK

Common Commands

IEEE common capabilities

Option/Plug-In Fitted	Returned Result
Broadband Auxiliary Testing	OYK
ATM Cell Level + PDH / DS _n interfaces	UKZ
Jitter Generation	UHK
Jitter Generation	A3K
PDH Jitter Measurement + Wander/Slips	UHN
STM-1 Electrical Jitter Measurement	A1M
STM-1 Optical Jitter Measurement	A1N
STM-1/4 Optical Jitter Measurement	A1P
STM-1 Electrical Jitter Measurement & Jitter Transfer	A3L
STM-1 Optical Jitter Measurement & Jitter Transfer	A3V
STM-1/4 Optical Jitter Measurement & Jitter Transfer	A3N
In Lid Printer	UKX
HP-IB / RS-232-C Remote Control + Parallel Printer Port	A3D
HP-IB / RS-232-C / LAN Remote Control + Parallel Printer Port	A3B
Distributed Network Analysis	USS

If more than one Option/Plug-In combination is fitted a complete list is returned with each list item separated by a comma : UKJ,A3B,A1T,USN,UHK,A1P

***PSC <numeric>**

Sets the value of the Power On Status Clear flag. Controls the automatic clearing of SRQ Enable register, Standard ESR & Parallel Poll Enable register after power on. See IEE 488.2 Section 10.25.

***PSC?**

Returns the status of the PSC flag.

***RCL <numeric>**

Recall Stored Settings - Sets the instrument to a set of previously stored settings. Numeric is in the range 0 to 9 and determines which set of stored settings is recalled.

Common Commands

IEEE common capabilities

***RST**

Set the instrument to the Default settings listed in Appendix A.

***SAV <numeric>**

Save Stored Settings - Stores the current instrument settings. Numeric is in the range 1 to 9 and determines the store location.

***SRE <numeric>**

Service Request Enable - Sets the status byte mask.

<numeric> =	8	QUES Status Summary
	16	Message Available
	32	Event Status Summary
	64	Request Service
	128	OPER Status Summary

***SRE?**

Service Request Enable Query - Returns the current mask setting in numeric form.

***STB?**

Status Byte Query - Returns the value of the status byte in numeric form.

***TRG**

Trigger - Not implemented on HP 37717C .

***TRG?**

Trigger Query - Not implemented on HP 37717C .

***WAI**

Wait To Continue - Not implemented on the HP 37717C.

Common Commands
IEEE common capabilities

PDH SCPI Command Reference

OUTPut subsystem, see page 3- 4.

SOURce subsystem- Transmitter Unstructured PDH Commands, see page 3-9.

SOURce subsystem -Transmitter Structured PDH Commands,see page 3- 17.

SOURce subsystem - Transmitter SPDH Test Signal Settings Commands, see page 3-28.

SOURce subsystem - Transmitter SPDH Test Function Commands, see page 3- 36.

INPut subsystem, see page 3-51.

SENSe subsystem - Receiver Unstructured PDH Settings, see page 3-57.

SENSe subsystem - Receiver Structured PDH Settings, see page 3-62.

SENSe subsystem - Receiver SPDH Test Signal Settings Commands, see page 3- 68.

SENSe subsystem - Receiver SPDH Test Function Commands, see page 3- 74.

SENSe subsystem - Analysis Control, see page 3- 75.

SENSe subsystem - Alarm Scan Control, see page 3-80.

SENSe subsystem - SPDH Round Trip Delay Control,see page 3- 81.

SENSe subsystem - Result Returning Commands, see page 3-82.

FETCh subsystem, see page 3- 103.

PDH Command Reference

PDH Command Reference

PDH Command Reference

This chapter contains detailed information on the SCPI (Standard Commands for Programming Instruments) and IEEE 488.2 common commands you will use when writing programs to control your HP 37717C for PDH operation.

Please also refer to chapter 2 Common Commands for general information on SCPI command formats and for a list of commands that are common to PDH, SDH, SONET, ATM or Jitter operation; they are as follows:

SCPI Command Format

Remote Control Commands

Instrument Options

INSTRument subsystem

SOURce subsystem

SOURce subsystem - Transmitter Common Commands

INPut subsystem

SENSe subsystem

SENSe subsystem - Receiver Common Commands

SENSe subsystem - Test Timing

SENSe subsystem - Analysis Control

SENSe subsystem - Trouble Scan Results

SENSe subsystem - Configuring Graphics,

SENSe subsystem - Managing Graphics Stores

SENSe subsystem - Retrieving Graphics Store Data

SENSe subsystem - Retrieving Data for a Single Graph

SENSe subsystem - Obtaining Graphics End of Measurement Results

STATus Subsystem

SYSTem Subsystem

IEEE common capabilities

PDH Command Reference

OUTPut subsystem

<discrete> =	UNBalanced	75 Ω Unbalanced
	BALanced	120 Ω Balanced

Selects the Unstructured PDH transmitter termination level. 120 Ω Balanced is only allowed when :OUTPut:TELEcom:PDH:RATE <discrete> is set to M2 or K704.

The corresponding query returns the Unstructured PDH level in discrete form as listed above.

:OUTPut:TELEcom:PDH:BALance?

Returns : <discrete>

:OUTPut:TELEcom:PDH:BINary:INTerface <discrete>

<discrete> =	CODeD	Non Binary interface
	BINary	Binary interface

Selects between coded and binary interfaces.

The corresponding query returns the interface type in discrete form as listed above.

:OUTPut:TELEcom:PDH:BINary:INTerface?

Returns : <discrete>

:OUTPut:TELEcom:SPDH:RATE <discrete>

<discrete> =	M140	140Mb/s (Option UKJ only)
	M34	34Mb/s
	M8	8Mb/s (Option UKJ only)
	M2	2Mb/s
	DS1	1.544 Mb/s (Option 110 only)
	DS3	44.736 Mb/s (Option 110 only)

Sets the output rate for the PDH electrical output port. This command is only valid when :SOURce:DATA:TELEcom:SOURce <discrete> is set to PDH .

PDH Command Reference

OUTPut subsystem

The corresponding query returns the Structured PDH rate in discrete form as listed above.

:OUTPut:TELEcom:SPDH:RATE?

Returns : <discrete>

:OUTPut:TELEcom:SPDH:CODE <discrete>

<discrete> =	AMI	8 Mb/s, 2 Mb/s, 704 kb/s
	HDB3	34 Mb/s, 8 Mb/s, 2 Mb/s, 704 kb/s
	CMI	140 Mb/s only
	B3ZS	DS1
	B8ZS	DS3

Selects the Structured PDH interface line code for the transmitter.

The corresponding query returns the Structured PDH code in discrete form as listed above.

:OUTPut:TELEcom:SPDH:CODE?

Returns : <discrete>

:OUTPut:TELEcom:SPDH:DROP:CODE <discrete>

<discrete> =	AMI	2Mb/s, DS1
	HDB3	2Mb/s only
	B8ZS	DS1 only

Option 110 only. Selects the Structured PDH drop port interface line code for the receiver.

The corresponding query returns the line code in discrete form as listed above.

:OUTPut:TELEcom:SPDH:DROP:CODE?

Returns: <discrete>

PDH Command Reference

OUTPut subsystem

:OUTPut:TELEcom:SPDH:LEVel <discrete>

<discrete> =	DSX	
	HIGH	DS3 only
	FT900	
	LOW	DS1 only

Sets the DS3/DS1 output level. The corresponding query command returns the current setting.

:OUTPut:TELEcom:SPDH:LEVel?

Returns	<discrete>
---------	------------

:OUTPut:TELEcom:SPDH:BALance <discrete>

<discrete> =	UNBalanced	75 Ω Unbalanced
	BALanced	120 Ω Balanced

Selects the Structured PDH transmitter termination level. 120 Ω Balanced is only allowed when :OUTPut:TELEcom:SPDH:RATE <discrete> is set to M2 .

The corresponding query returns the Structured PDH level in discrete form as listed above.

:OUTPut:TELEcom:SPDH:BALance?

Returns :	<discrete>
-----------	------------

:OUTPut:TELEcom:SPDH:STATe <boolean>

<boolean> =	0 or OFF
	1 or ON

Disable or enable the transmitter output, equivalent to generating or disabling Loss Of Signal. Disabling the output is only permitted when :SOURce:DATA:TELEcom:TFUNction <discrete> is set to PDH or PDHPayload, and :SOURce:DATA:TELEcom:SPDH:TFUNction:TYPE <discrete> is set to ERRor.

PDH Command Reference

OUTPut subsystem

The corresponding query command returns the current state of the output.

NOTE

Issuing command :OUTPut:TELEcom:SPDH:STATe <boolean> has the effect of disabling any active SPDH alarm. Similarly, issuing any SPDH alarm command, for example, :SOURce:DATA:TELEcom:SPDH:M140:ALARm <discrete> has the effect of automatically enabling the transmitter output.

:OUTPut:TELEcom:SPDH:STATe?

Returns:

<boolean>

SOURce subsystem- Transmitter Unstructured PDH Commands

SOURce subsystem- Transmitter Unstructured PDH Commands

:SOURce:CLOCK:PDH:SOURce <discrete>

<discrete> =	INTernal	Internal Clock
	RECovered	Recovered Clock
	JITTer	External timing reference
	BINary	Binary interface only

Selects the clock source for the Unstructured PDH transmitter. RECovered is only valid when :OUTPut:TELEcom:PDH:RATE <discrete> is set to M2 or K704. JITTer is only valid when a Jitter Generation option is fitted and :OUTPut:TELEcom:PDH:RATE <discrete> is set to M2 . BINary is only valid if Binary Interfaces option is fitted.

The corresponding query returns the Unstructured PDH clock source in discrete form as listed above.

:SOURce:CLOCK:PDH:SOURce?

Returns : <discrete>

:SOURce:CLOCK:PDH:K704:FOFFset <discrete>

<discrete> =	NONE	Off
	PMAX	CCITT maximum +50 ppm
	NMAX	CCITT maximum -50 ppm
	USER	± 100 ppm

Selects the Unstructured PDH transmitter 704 kHz clock offset type. If USER is selected, the amount of offset is set using :SOURce:CLOCK:PDH:K704:FOFFset:OFFSet <numeric>.

The corresponding query returns the Unstructured PDH 704 kHz clock offset type in discrete form as listed above.

SOURce subsystem- Transmitter Unstructured PDH Commands

:SOURce:CLOCK:PDH:K704:FOFFset?

Returns : <discrete>

:SOURce:CLOCK:PDH:K704:FOFFset:OFFSet <numeric>

<numeric> = -100 to +100 1 ppm steps.

Sets the USER frequency offset in parts per million (ppm) for the Unstructured PDH transmitter 704 kHz clock if :SOURce:CLOCK:PDH:K704:FOFFset <discrete> is set to USER. Default = 0.

The corresponding query returns the USER 704 kHz clock offset in numeric form as listed above.

:SOURce:CLOCK:PDH:K704:FOFFset:OFFSet?

Returns : <numeric>

:SOURce:CLOCK:PDH:M2:FOFFset <discrete>

<discrete> =	NONE	Off
	PMAX	CCITT maximum +50 ppm
	NMAX	CCITT maximum -50 ppm
	USER	± 100 ppm

Selects the Unstructured PDH transmitter 2.048 MHz clock offset type. If USER is selected, the amount of offset is set using

:SOURce:CLOCK:PDH:M2:FOFFset:OFFSet <numeric>.

The corresponding query returns the Unstructured PDH 2.048 MHz clock offset type in discrete form as listed above.

:SOURce:CLOCK:PDH:M2:FOFFset?

Returns : <discrete>

:SOURce:CLOCK:PDH:M2:FOFFset:OFFSet <numeric>

<numeric> = -100 to +100 1 ppm steps.

SOURce subsystem- Transmitter Unstructured PDH Commands

Sets the USER frequency offset in parts per million (ppm) for the Unstructured PDH transmitter 2.048 MHz clock if `:SOURce:CLOCK:PDH:M2:FOFFset <discrete>` is set to USER .

The corresponding query returns the USER 2.048 MHz clock offset in numeric form as listed above.

:SOURce:CLOCK:PDH:M2:FOFFset:OFFSet?

Returns : `<numeric>`

:SOURce:CLOCK:PDH:M8:FOFFset <discrete>

<code><discrete> =</code>	NONE	Off
	PMAX	CCITT maximum +30 ppm
	NMAX	CCITT maximum -30 ppm
	USER	± 100 ppm

Selects the Unstructured PDH transmitter 8.448 MHz clock offset type. If USER is selected, the amount of offset is set using

`:SOURce:CLOCK:PDH:M8:FOFFset:OFFSet <numeric>`.

The corresponding query returns the Unstructured PDH 8.448 MHz clock offset type in discrete form as listed above.

:SOURce:CLOCK:PDH:M8:FOFFset?

Returns : `<discrete>`

:SOURce:CLOCK:PDH:M8:FOFFset:OFFSet <numeric>

`<numeric> =` -100 to +100 1 ppm steps.

Sets the USER frequency offset in parts per million (ppm) for the Unstructured PDH transmitter 8.448 MHz clock if `:SOURce:CLOCK:PDH:M8:FOFFset <discrete>` is set to USER.

The corresponding query returns the USER 8.448 MHz clock offset in numeric form as listed above.

:SOURce:CLOCK:PDH:M8:FOFFset:OFFSet?

SOURce subsystem- Transmitter Unstructured PDH Commands

Returns : <numeric>

:SOURce:CLOCK:PDH:M34:FOFFset <discrete>

<discrete> =	NONE	Off
	PMAX	CCITT maximum +20 ppm
	NMAX	CCITT maximum -20 ppm
	USER	± 100 ppm

Selects the Unstructured PDH transmitter 34.368 MHz clock offset type. If USER is selected, the amount of offset is set using

:SOURce:CLOCK:PDH:M34:FOFFset:OFFSet <numeric>.

The corresponding query returns the Unstructured PDH 34.368 MHz clock offset type in discrete form as listed above.

:SOURce:CLOCK:PDH:M34:FOFFset?

Returns : <discrete>

:SOURce:CLOCK:PDH:M34:FOFFset:OFFSet <numeric>

<numeric> = -100 to +100 1 ppm steps.

Sets the USER frequency offset in parts per million (ppm) for the Unstructured PDH transmitter 34.368 MHz clock if :SOURce:CLOCK:PDH:M34:FOFFset <discrete> is set to USER .

The corresponding query returns the USER 34.368 MHz clock offset in numeric form as listed above.

:SOURce:CLOCK:PDH:M34:FOFFset:OFFSet?

Returns : <numeric>

:SOURce:CLOCK:PDH:M140:FOFFset <discrete>

<discrete> =	NONE	Off
	PMAX	CCITT maximum +15 ppm

SOURce subsystem- Transmitter Unstructured PDH Commands

NMAX	CCITT maximum -15 ppm
USER	± 100 ppm

Selects the Unstructured PDH transmitter 139.264 MHz clock offset type. If USER is selected, the amount of offset is set using :SOURce:CLOCK:PDH:M140:FOFFset:OFFSet <numeric>.

The corresponding query returns the Unstructured PDH 139.264 MHz clock offset type in discrete form as listed above.

:SOURce:CLOCK:PDH:M140:FOFFset?

Returns : <discrete>

:SOURce:CLOCK:PDH:M140:FOFFset:OFFSet <numeric>

<numeric> = -100 to +100 1 ppm steps.

Sets the USER frequency offset in parts per million (ppm) for the Unstructured PDH transmitter 139.264 MHz clock if :SOURce:CLOCK:PDH:M140:FOFFset <discrete> is set to USER .

The corresponding query returns the USER 139.264 MHz clock offset in numeric form as listed above.

:SOURce:CLOCK:PDH:M140:FOFFset:OFFSet?

Returns : <numeric>

:SOURce:DATA:TELEcom:PDH:PAYLoad:PATtern <discrete>

<discrete> =	PRBS15	2 ¹⁵ -1
	PRBS23	2 ²³ -1
	AZERo	All Zero's
	AONE	All One's
	P1010	Word 1010
	P1000	Word 1000
	UWORD	16 Bit User Word

SOURce subsystem- Transmitter Unstructured PDH Commands

Selects the Unstructured PDH transmitter data pattern. If UWORD is selected, the word pattern is set using :SOURce:DATA:TELEcom:PDH:PAYLoad:UWORD <string>.

The corresponding query returns the data pattern in discrete form as listed above.

:SOURce:DATA:TELEcom:PDH:PAYLoad:PATtern?

Returns : <discrete>

:SOURce:DATA:TELEcom:PDH:PAYLoad:UWORD <string>

Sets the Unstructured PDH transmitter user word pattern in the range "0000000000 000000" to "1111111111111111"

The corresponding query returns the user word pattern as a string as listed above.

:SOURce:DATA:TELEcom:PDH:PAYLoad:UWORD?

Returns : <string>

:SOURce:DATA:TELEcom:PDH:ERRor:RATE <discrete>

<discrete> =	NONE	stop error generation
	E_3	1.0e-3 error rate
	ONCE	inject a single error

Sets the Unstructured PDH transmitter error rate.

The corresponding query returns the transmitter error rate in discrete form as listed above.

:SOURce:DATA:TELEcom:PDH:ERRor:RATE?

Returns: <discrete>

:SOURce:DATA:TELEcom:PDH:BINary:THREshold:CLOCK <discrete>

<discrete> =	ECL
	TTL

Binary interface option only. Selects the transmitter binary clock threshold.

SOURce subsystem- Transmitter Unstructured PDH Commands

The corresponding query returns the transmitter binary clock threshold level in discrete form as listed above.

:SOURce:DATA:TELEcom:PDH:BINary:THReshold:CLOCK?

Returns : <discrete>

:SOURce:DATA:TELEcom:PDH:BINary:POLarity:CLOCK <discrete>

<discrete> = NORMal
 INVerted

Binary Interface option only. Selects the transmitter binary clock polarity.

The corresponding query returns the transmitter binary clock polarity type in discrete form as listed above.

:SOURce:DATA:TELEcom:PDH:BINary:POLarity:CLOCK?

Returns : <discrete>

:SOURce:DATA:TELEcom:PDH:BINary:THReshold:DATA <discrete>

<discrete> = ECL
 TTL

Binary Interface option only. Selects the transmitter binary data threshold.

The corresponding query returns the transmitter binary data threshold level in discrete form as listed above.

:SOURce:DATA:TELEcom:PDH:BINary:THReshold:DATA?

Returns : <discrete>

:SOURce:DATA:TELEcom:PDH:BINary:POLarity:DATA <discrete>

<discrete> = NORMal
 INVerted

Binary Interface option only. Selects the transmitter binary data polarity.

PDH Command Reference

SOURce subsystem- Transmitter Unstructured PDH Commands

The corresponding query returns the transmitter binary data polarity type in discrete form as listed above.

:SOURce:DATA:TELEcom:PDH:BINary:POLarity:DATA?

Returns : <discrete>

SOURce subsystem -Transmitter Structured PDH Commands

SOURce subsystem -Transmitter Structured PDH Commands

:SOURce:CLOCK:SPDH:SOURce <discrete>

<discrete> =	INTernal	Internal Clock
	RECovered	Recovered Clock
	JITTer	External timing reference
	BINary	Binary Interface option only

Selects the clock source for the Structured PDH transmitter. JITTER is only valid when Jitter Generation option is fitted. BINary is only valid if Binary Interfaces option is fitted.

The corresponding query returns the Structured PDH clock source in discrete form as listed above.

:SOURce:CLOCK:SPDH:SOURce?

Returns : <discrete>

:SOURce:CLOCK:SPDH:M2:FOFFset <discrete>

<discrete> =	NONE	Off
	PMAX	CCITT max +50 ppm
	NMAX	CCITT max -50 ppm
	USER	± 100 ppm

Selects the Structured PDH transmitter 2.048 MHz clock offset type. If USER is selected, the amount of offset is set using

:SOURce:CLOCK:SPDH:M2:FOFFset:OFFSet <numeric>,<discrete>.

The corresponding query returns the Structured PDH 2.048 MHz clock offset type in discrete form as listed above.

SOURce subsystem -Transmitter Structured PDH Commands

:SOURce:CLOCK:SPDH:M2:FOFFset?

Returns : <discrete>

:SOURce:CLOCK:SPDH:M2:FOFFset:OFFSet <numeric>,<discrete>

<numeric> =	-100 to +100	parts per million
	-0.000100 to 0.000100	percentage or ratio
<discrete> =	PPM	parts per million
	PCT	Percentage

Sets the USER frequency offset for the Structured PDH transmitter 2.048 MHz clock if :SOURce:CLOCK:SPDH:M2:FOFFset <discrete> is set to USER is selected. If Ratio is chosen as the means of specifying offset then no <discrete> parameter is required.

The corresponding query returns the USER 2.048 MHz clock offset in parts per million.

:SOURce:CLOCK:SPDH:M2:FOFFset:OFFSet?

Returns : <numeric>

:SOURce:CLOCK:SPDH:M8:FOFFset <discrete>

<discrete> =	NONE	Off
	PMAX	CCITT maximum +30 ppm
	NMAX	CCITT maximum -30 ppm
	USER	± 100 ppm

Selects the Structured PDH transmitter (option UKJ only) 8.448 MHz clock offset type. If USER is selected, the amount of offset is set using

:SOURce:CLOCK:SPDH:M8:FOFFset:OFFSet <numeric>,<discrete>.

The corresponding query returns the Structured PDH 8.448 MHz clock offset type in discrete form as listed above.

SOURce subsystem -Transmitter Structured PDH Commands

:SOURce:CLOCK:SPDH:M8:FOFFset?

Returns : <discrete>

:SOURce:CLOCK:SPDH:M8:FOFFset:OFFSet <numeric>,<discrete>

<numeric> =	-100 to +100	parts per million
	-0.000100 to 0.000100	percentage or ratio
<discrete> =	PPM	parts per million
	PCT	Percentage

Sets the USER frequency offset for the Structured PDH transmitter (option UKJ only) 8.448 MHz clock if :SOURce:CLOCK:SPDH:M8:FOFFset <discrete> is set to USER. If Ratio is chosen as the means of specifying offset then no <discrete> parameter is required.

The corresponding query returns the USER 8.448 MHz clock offset in parts per million.

:SOURce:CLOCK:SPDH:M8:FOFFset:OFFSet?

Returns : <numeric>

:SOURce:CLOCK:SPDH:M34:FOFFset <discrete>

<discrete> =	NONE	Off
	PMAX	CCITT max +20 ppm; DS3
	NMAX	CCITT max -20 ppm; DS3
	USER	± 100 ppm

Selects the Structured PDH transmitter 34.368 MHz clock offset type. If USER is selected, the amount of offset is set using

:SOURce:CLOCK:SPDH:M34:FOFFset:OFFSet <numeric>,<discrete>.

The corresponding query returns the Structured PDH 34.368 MHz clock offset type in discrete form as listed above.

SOURce subsystem -Transmitter Structured PDH Commands

:SOURce:CLOCK:SPDH:M34:FOFFset?

Returns : <discrete>

:SOURce:CLOCK:SPDH:M34:FOFFset:OFFSet <numeric>,<discrete>

<numeric> =	-100 to +100	parts per million
	-0.000100 to 0.000100	percentage or ratio
<discrete> =	PPM	parts per million
	PCT	Percentage

Sets the USER frequency offset for the Structured PDH transmitter 34.368 MHz clock if :SOURce:CLOCK:SPDH:M34:FOFFset <discrete> is set to USER . If Ratio is chosen as the means of specifying offset then no <discrete> parameter is required.

The corresponding query returns the USER 34.368 MHz clock offset in parts per million.

:SOURce:CLOCK:SPDH:M34:FOFFset:OFFSet?

Returns : <numeric>

:SOURce:CLOCK:SPDH:M140:FOFFset <discrete>

<discrete> =	NONE	Off
	PMAX	CCITT maximum +15 ppm
	NMAX	CCITT maximum -15 ppm
	USER	± 100 ppm

Selects the Structured PDH transmitter (Option UKJ only) 139.264 MHz clock offset type. If USER is selected, the amount of offset is set using

:SOURce:CLOCK:SPDH:M140:FOFFset:OFFSet <numeric>,<discrete>.

The corresponding query returns the Structured PDH 139.264 MHz clock offset type in discrete form as listed above.

:SOURce:CLOCK:SPDH:M140:FOFFset?

Returns : <discrete>

SOURce subsystem -Transmitter Structured PDH Commands

:SOURce:CLOCK:SPDH:M140:FOFFset:OFFSet <numeric>,<discrete>

<numeric> =	-100 to +100	parts per million
	-0.000100 to 0.000100	percentage or ratio
<discrete> =	PPM	parts per million
	PCT	Percentage

Sets the USER frequency offset for the Structured PDH transmitter (Option UKJ only) 139.264 MHz clock if :SOUR:CLOC:SPDH:M140:FOFF <discrete> is set to USER. If Ratio is chosen as the means of specifying offset then no <discrete> parameter is required.

The corresponding query returns the USER 139.264 MHz clock offset in parts per million.

:SOURce:CLOCK:SPDH:M140:FOFFset:OFFSet?

Returns : <numeric>

:SOURce:CLOCK:SPDH:DS3:FOFFset <discrete>

<discrete> =	NONE	Off
	PMAX	ANSI maximum +20 ppm
	NMAX	ANSI maximum - 20 ppm
	USER	± 100 ppm

Selects the DSn transmitter (Option 110 only) DS3 clock offset type. If USER is selected, the amount of offset is set using

:SOURce:CLOCK:SPDH:DS3:FOFFset:OFFSet <numeric>,<discrete>.

The corresponding query returns the DS3 clock offset type in discrete form as listed above.

:SOURce:CLOCK:SPDH:DS3:FOFFset?

Returns : <discrete>

SOURce subsystem -Transmitter Structured PDH Commands

:SOURce:CLOCK:SPDH:DS3:FOFFset:OFFSet <numeric>,<discrete>

<numeric> =	-100 to +100	parts per million
	-0.000100 to 0.000100	percentage or ratio
<discrete> =	PPM	parts per million
	PCT	Percentage

Sets the USER frequency offset for the Structured PDH transmitter (Option 110 only) DS3 clock if :SOURce:CLOCK:SPDH:DS3:FOFFset <discrete> is set to USER . If Ratio is chosen as the means of specifying offset then no <discrete> parameter is required.

The corresponding query returns the USER DS3 clock offset in parts per million.

:SOURce:CLOCK:SPDH:DS3:FOFFset:OFFSet?

Returns : <numeric>

:SOURce:CLOCK:SPDH:DS1:FOFFset <discrete>

<discrete> =	NONE	Off
	PMAX	ANSI maximum +32 ppm
	NMAX	ANSI maximum - 32 ppm
	USER	± 100 ppm

Selects the DS_n transmitter DS1 (Option 110 only) clock offset type. If USER is selected, the amount of offset is set using

:SOURce:CLOCK:SPDH:DS1:FOFFset:OFFSet <numeric>,<discrete>.

The corresponding query returns the DS1 clock offset type in discrete form as listed above.

:SOURce:CLOCK:SPDH:DS1:FOFFset?

Returns : <discrete>

SOURce subsystem -Transmitter Structured PDH Commands

:SOURce:CLOCK:SPDH:DS1:FOFFset:OFFSet <numeric>,<discrete>

<numeric> =	-100 to +100	parts per million
	-0.000100 to 0.000100	percentage or ratio
<discrete> =	PPM	parts per million
	PCT	Percentage

Sets the USER frequency offset for the Structured PDH transmitter (Option 110 only) DS1 clock if :SOURce:CLOCK:SPDH:DS1:FOFFset <discrete> is set to USER. If Ratio is chosen as the means of specifying offset then no <discrete> parameter is required.

The corresponding query returns the USER DS1 clock offset in parts per million.

:SOURce:CLOCK:SPDH:DS1:FOFFset:OFFSet?

Returns : <numeric>

:SOURce:DATA:TELEcom:SPDH:PATtern <discrete>

<discrete> =	PRBS9	$2^9 - 1$
	PRBS11	$2^{11} - 1$
	PRBS15	$2^{15} - 1$
	PRBS20	$2^{20} - 1$
	QRSS	$2^{20} - 1$ with 14 zero limit (DS1 only with Option 110)
	PRBS23	$2^{23} - 1$
	AZERo	All zeros
	AONE	All ones
	STress	3-in-24 stress pattern (DS1 only with Option 110)
	P1010	word 1010

SOURce subsystem -Transmitter Structured PDH Commands

P1000	word 1000
UWORD	16 bit user word

Selects the Structured PDH transmitter data pattern. If UWORD is selected the word is set using :SOURce:DATA:TELEcom:SPDH:UWORD <string> . If service disruption is active a settings conflict error will occur.

The corresponding query returns the data pattern in discrete form as listed above.

:SOURce:DATA:TELEcom:SPDH:PATtern?

Returns : <discrete>

:SOURce:DATA:TELEcom:SPDH:UWORD <string>

Sets the Structured PDH transmitter user word pattern in the range "000000000000000" to "1111111111111111".

The corresponding query returns the user word pattern as a string as listed above.

:SOURce:DATA:TELEcom:SPDH:UWORD?

Returns : <string>

:SOURce:DATA:TELEcom:SPDH:PRBS:POLarity <discrete>

<discrete> =	INVerted	CCITT conformity
	NORMal	Non CCITT

Sets the polarity of the PRBS pattern of the Structured PDH transmitter.

The corresponding query returns the polarity in discrete form as listed above.

:SOURce:DATA:TELEcom:SPDH:PRBS:POLarity?

Returns: <discrete>

:SOURce:DATA:TELEcom:SPDH:PAYLoad:TYPE <discrete>

<discrete> =	UNFRamed	No Framing
	FRAMed	8, 34 and 140Mb/s

SOURce subsystem -Transmitter Structured PDH Commands

PCM30	2Mb/s only
PCM31	2Mb/s only
PCM30CRC	2Mb/s only
PCM31CRC	2Mb/s only
D4	DS1 only (Opt 110)
ESF	DS1 only (Opt 110)
SLC96	DS1 only (Opt 110)
M13	DS3 only (Opt 110)
CBIT	DS3 only (Opt 110)

Selects the Structured PDH transmitter interface rate framing.

Note that this command is not backwards compatible. To set the payload to be structured, use the command

:SOURce:DATA:TELEcom:SPDH:PAYLoad:STRucture <discrete>

The corresponding query returns the framing in discrete form as listed above.

:SOURce:DATA:TELEcom:SPDH:PAYLoad:TYPE?

Returns: <discrete>

:SOURce:DATA:TELEcom:SPDH:PAYLoad:STRucture <discrete>

<discrete> =	UNSTructured	All rates
	STRuctured	All framed formats

Selects whether or not the PDH signal is to have any further structure or not.

The corresponding query returns the type in discrete form as listed above.

:SOURce:DATA:TELEcom:SPDH:PAYLoad:STRucture?

Returns: <discrete>

SOURce subsystem -Transmitter Structured PDH Commands

:SOURce:DATA:TELEcom:SPDH:TSLot:SIGNaling:DATA:M2 <string>

<string> = 4 bit string

Selects the signaling bits for 2Mb/s CAS framing to be transmitted.

The corresponding query returns the signaling bits selected as a 4 bit binary string.

:SOURce:DATA:TELEcom:SPDH:TSLot:SIGNaling:DATA:M2?

Returns: <string>

:SOURce:DATA:TELEcom:SPDH:BINary:THREshold:CLOCK <discrete>

<discrete> = ECL
TTL

Binary Interfaces option only. Selects the transmitter binary clock threshold.

The corresponding query returns the transmitter binary clock threshold level in discrete form as listed above.

:SOURce:DATA:TELEcom:SPDH:BINary:THREshold:CLOCK?

Returns : <discrete>

:SOURce:DATA:TELEcom:SPDH:BINary:POLarity:CLOCK <discrete>

<discrete> = NORMal
INVerted

Binary Interfaces option only. Selects the transmitter binary clock polarity.

The corresponding query returns the transmitter binary clock polarity type in discrete form as listed above.

:SOURce:DATA:TELEcom:SPDH:BINary:POLarity:CLOCK?

Returns : <discrete>

SOURce subsystem -Transmitter Structured PDH Commands

:SOURce:DATA:TELEcom:SPDH:BINary:THReshold:DATA <discrete>

<discrete> = ECL

TTL

Binary Interfaces option only. Selects the transmitter binary data threshold.

The corresponding query returns the transmitter binary data threshold level in discrete form as listed above.

:SOURce:DATA:TELEcom:SPDH:BINary:THReshold:DATA?

Returns : <discrete>

:SOURce:DATA:TELEcom:SPDH:BINary:POLarity:DATA <discrete>

<discrete> = NORMal

INVerted

Binary Interfaces option only. Selects the transmitter binary data polarity.

The corresponding query returns the transmitter binary data polarity type in discrete form as listed above.

:SOURce:DATA:TELEcom:SPDH:BINary:POLarity:DATA?

Returns : <discrete>

SOURce subsystem - Transmitter SPDH Test Signal Settings Commands

SOURce subsystem - Transmitter SPDH Test Signal Settings Commands

:SOURce:DATA:TELEcom:SPDH:TSIGnal:RATE <discrete>

<discrete> =	M34	34 Mb/s
	M8	8 Mb/s
	M2	2 Mb/s
	K64	64 kb/s
	K64XN	Nx64 kb/s
	DS1	DS1 rate (Option 110 only)
	K56	56 kb/s (Option 110 only)
	K56XN	Nx56 kb/s (Option 110 only)

Selects the Structured PDH transmitter test signal rate.
The corresponding query returns the test signal rate in discrete form as listed above.

:SOURce:DATA:TELEcom:SPDH:TSIGnal:RATE?

Returns : <discrete>

:SOURce:DATA:TELEcom:SPDH:TSIGnal:PAYLoad <discrete>

<discrete> =	UNFRamed	2, 8 & 34 Mb/s
	FRAMed	8 & 34 Mb/s
	PCM30	2 Mb/s & 64 kb/s
	PCM31	2 Mb/s & 64 kb/s
	PCM30CRC	2 Mb/s & 64 kb/s
	PCM31CRC	2 Mb/s & 64 kb/s
	IM2	2 Mb/s

**SOURce subsystem - Transmitter SPDH Test Signal Settings
Commands**

D4	DS1 (Option 110 only)
ESF	DS1 (Option 110 only)
SLC96	DS1 (Option 110 only)
IDS1	Insert DS1 (Option 110 only)

Selects the Structured PDH transmitter test signal framing.

The corresponding query returns the framing in discrete form as listed above.

:SOURce:DATA:TELEcom:SPDH:TSIGnal:PAYLoad?

Returns : <discrete>

:SOURce:DATA:TELEcom:SPDH:TSIGnal:TRIButary:M34 <discrete>

<discrete> = TRIB1
TRIB2
TRIB3
TRIB4

Selects the Structured PDH transmitter 34 Mb/s tributary test signal.

The corresponding query returns the 34 Mb/s tributary test signal in discrete form.

:SOURce:DATA:TELEcom:SPDH:TSIGnal:TRIButary:M34?

Returns : <discrete>

:SOURce:DATA:TELEcom:SPDH:TSIGnal:TRIButary:M8 <discrete>

<discrete> = TRIB1
TRIB2
TRIB3
TRIB4

PDH Command Reference

SOURce subsystem - Transmitter SPDH Test Signal Settings Commands

Selects the Structured PDH transmitter 8 Mb/s tributary test signal.

The corresponding query returns the 8 Mb/s tributary test signal in discrete form.

:SOURce:DATA:TELEcom:SPDH:TSIGnal:TRIButary:M8?

Returns : <discrete>

:SOURce:DATA:TELEcom:SPDH:TSIGnal:TRIButary:M2 <discrete>

<discrete> = TRIB1
 TRIB2
 TRIB3
 TRIB4

Selects the Structured PDH transmitter 2 Mb/s tributary test signal.

The corresponding query returns the 2 Mb/s tributary test signal in discrete form.

:SOURce:DATA:TELEcom:SPDH:TSIGnal:TRIButary:M2?

Returns : <discrete>

:SOURce:DATA:TELEcom:SPDH:TSIGnal:TRIButary:DS1 <discrete>

<discrete> = TRIB1
 TRIB2
 TRIB3
 TRIB4

Selects the Structured PDH transmitter DS1 tributary test signal. This command applies to Option 110 only. The corresponding query returns the tributary in discrete form as listed above.

:SOURce:DATA:TELEcom:SPDH:TSIGnal:TRIButary:DS1?

Returns: <discrete>

PDH Command Reference

**SOURce subsystem - Transmitter SPDH Test Signal Settings
Commands**

:SOURce:DATA:TELEcom:SPDH:TSIGnal:TRIButary:DS2 <discrete>

<discrete> =	TRIB1
	TRIB2
	TRIB3
	TRIB4
	TRIB5
	TRIB6
	TRIB7

Selects the Structured PDH transmitter DS2 tributary test signal. This command applies to Option 110 only.

The corresponding query returns the tributary in discrete form as listed above.

:SOURce:DATA:TELEcom:SPDH:TSIGnal:TRIButary:DS2?

Returns: <discrete>

:SOURce:DATA:TELEcom:SPDH:TSIGnal:TSLot:DS1:K56 <numeric>

<numeric> 1 to 24 Any framing

Selects the PDH transmitter 56kb/s timeslot. Option 110 only.

The corresponding query returns the 56kb/s timeslot in numeric form.

:SOURce:DATA:TELEcom:SPDH:TSIGnal:TSLot:DS1:K56?

Returns: <numeric>

Option 110 only

:SOURce:DATA:TELEcom:SPDH:TSIGnal:TSLot:DS1:K64 <numeric>

**SOURce subsystem - Transmitter SPDH Test Signal Settings
Commands**

<numeric> 1 to 24 Any framing

Selects the PDH transmitter 56kb/s timeslot. Applies to Option 110 only.
The corresponding query returns the 56kb/s timeslot in numeric form.

:SOURce:DATA:TELEcom:SPDH:TSIGnal:TSLot:DS1:K64?

Returns: <numeric>

Option 110 only

:SOURce:DATA:TELEcom:SPDH:TSIGnal:TSLot:M2:K64 <numeric>

<numeric> 1 to 31 PCM31 & PCM31CRC
 1 to 15 & 17 PCM30 & PCM30CRC
 to 31

Selects the PDH transmitter 64kb/s timeslot. Applies to Option 110 only.
The corresponding query returns the 64kb/s timeslot in numeric form.

:SOURce:DATA:TELEcom:SPDH:TSIGnal:TSLot:M2:K64?

Returns: <numeric>

:SOURce:DATA:TELEcom:SPDH:TSIGnal:TSLot:M2:K64XN <string>

<string> = 31 bit string

Selects the 64XN kb/s timeslots of the 2mb/s test signal. A "1" in the nth position signifies selection of timeslot n. A "0" signifies deselection e.g. to select timeslots 1,8,15,22,29 "100000010000001000000100000010".

The corresponding query returns the 64XNkb/s timeslot as a 31 bit binary string.

:SOURce:DATA:TELEcom:SPDH:TSIGnal:TSLot:M2:K64XN?

**SOURce subsystem - Transmitter SPDH Test Signal Settings
Commands**

Returns: <string>

:SOURce:DATA:TELEcom:SPDH:TSIGnal:TSLot:DS1:K64XN <string>

<string> = 24 bit string

Selects the 64XN kb/s timeslots of the DS1 signal. A "1" in the nth position signifies selection of timeslot n. A "0" signifies deselection e.g. to select timeslots 1,8,15,22 "10000001000000100000010". Applies to Option 110 only.

The corresponding query returns the 64XNkb/s timeslot as a 24 bit binary string.

:SOURce:DATA:TELEcom:SPDH:TSIGnal:TSLot:DS1:K64XN?

Returns: <string>

:SOURce:DATA:TELEcom:SPDH:TSIGnal:TSLot:DS1:K56XN <string>

<string> = 24 bit string

Selects the 56XN kb/s timeslots. A "1" in the nth position signifies selection of timeslot n. A "0" signifies deselection e.g. to select timeslots 1,8,15,22 "10000001000000100000010". Applies to Option 110 only.

The corresponding query returns the 56XNkb/s timeslot as a 24 bit binary string.

:SOURce:DATA:TELEcom:SPDH:TSIGnal:TSLot:DS1:K56XN?

Returns: <string>

:SOURce:DATA:TELEcom:SPDH:TSIGnal:BACKground <discrete>

<discrete> = AIS Alarm Indication Sequence

**SOURce subsystem - Transmitter SPDH Test Signal Settings
Commands**

PRBS9	2 ⁹ -1 PRBS
AS_FG	As foreground pattern

Selects the pattern to fill the non test signal tributaries.

The corresponding query returns the background pattern type in discrete form as listed above.

:SOURce:DATA:TELEcom:SPDH:TSignal:BACKground?

Returns : <discrete>

:SOURce:DATA:TELEcom:SPDH:TSLot:SIGNaling:DATA:DS1:D4 <string>

<string> = 2 bit string (Option 110 only)

Selects the signaling bits for DS1 D4 framing to be transmitted.

The corresponding query returns the signaling bits selected as a 2 bit binary string.

:SOURce:DATA:TELEcom:SPDH:TSLot:SIGNaling:DATA:DS1:ESF?

Returns: <string>

**:SOURce:DATA:TELEcom:SPDH:TSLot:SIGNaling:DATA:DS1:ESF
<string>**

<string> = 4 bit string (Option 110 only)

Selects the signaling bits for DS1 ESF framing to be transmitted.

The corresponding query returns the signaling bits selected as a 4 bit binary string.

:SOURce:DATA:TELEcom:SPDH:TSLot:SIGNaling:DATA:DS1:ESF?

Returns: <string>

**SOURce subsystem - Transmitter SPDH Test Signal Settings
Commands**

**:SOURce:DATA:TELEcom:SPDH:TSLot:SIGNaling:DATA:DS1:SLC96
<string>**

<string> = 2 character string (Option 110 only)

Selects the signaling bits for DS1 SLC96 framing to be transmitted.

Note that to select 'alternating' for either bit use the character 'A'

The corresponding query returns the signaling bits selected as a 2 character string, where 'A' means alternating.

:SOURce:DATA:TELEcom:SPDH:TSLot:SIGNaling:DATA:DS1:SLC96?

Returns: <string>

See also:

:SOURce:DATA:TELEcom:SPDH:PATtern <discrete>

:SOURce:DATA:TELEcom:SPDH:UWORD <string>

:SOURce:DATA:TELEcom:SPDH:PRBS:POLarity <discrete>

SOURCE subsystem - Transmitter SPDH Test Function Commands

See also common commands:

:SOURCE:DATA:TELEcom:TFUNCTION <discrete>

SOURCE subsystem- Transmitter Unstructured PDH Commands

:SOURCE:DATA:TELEcom:TFUNCTION:SDISruption <boolean>

<boolean>= OFF
 ON

Selects the Structured PDH transmitter special service disruption mode. This command is only valid if Option 110 is fitted and the test function is set to service disruption with :SOURCE:DATA:TELEcom:TFUNCTION <discrete>.

The corresponding query returns the special service disruption mode setting in discrete form as listed above.

:SOURCE:DATA:TELEcom:TFUNCTION:SDISruption?

Returns: <boolean>

:SOURCE:DATA:TELEcom:SPDH:TFUNCTION:TYPE <discrete>

<discrete> = ERROR Errors & Alarms
 SBITS Spare Bits

Sets the Structured PDH transmitter test function type.

The corresponding query returns the current Structured PDH test function type as listed above.

:SOURCE:DATA:TELEcom:SPDH:TFUNCTION:TYPE?

Returns: <discrete>

SOURce subsystem - Transmitter SPDH Test Function Commands

USER	User error rate (Option 110)
ONCE	Add single error

Sets the SPDH Error Add rate of the error type selected by :SOURce:DATA:TELEcom:SPDH:ERRor:TYPE <discrete> . ONCE will add a single error if the current rate is NONE. This command is applicable when :SOURce:DATA:TELEcom:TFUNction <discrete> is set to PDH. Setting a preset rate will also force the user rate to be the same value.

Associated commands:

:SOUR:DATA:TEL:SPDH:ERR:RATE:USER

The corresponding query returns the error add rate in discrete form. Note that if this query returns USER, then :SOUR:DATA:TEL:SPDH:ERR:RATE:USER? must be used to discover the currently injected error rate.

:SOURce:DATA:TELEcom:SPDH:ERRor:RATE?

Returns : <discrete>

:SOURce:DATA:TELEcom:SPDH:ERRor:RATE:USER <numeric>

<numeric> 1.1E-3 to 9.9E-9 mantissa resolution 0.1,
exponent resolution 1

This command is only applicable when Option 110 is fitted. Sets the user defined SPDH Error Add rate. Note that if :SOURce:DATA:TELEcom:SPDH:ERRor:RATE <discrete> is not already set to USER, then this command will automatically set it to USER.

Associated commands:

:SOURce:DATA:TELEcom:SPDH:ERRor:RATE <discrete>

The corresponding query returns the user defined SPDH Error Add rate in numeric form.

:SOURce:DATA:TELEcom:SPDH:ERRor:RATE:USER?

SOURce subsystem - Transmitter SPDH Test Function Commands

Returns: <numeric>

:SOURce:DATA:TELEcom:SPDH:ERRor:FRAMe:NERRored <discrete>

<discrete> =	ONE	1 frame
	TWO	2 frames
	THRee	3 frames
	FOUR	4 frames
	FIVE	5 frames (Option 110 only)
	SIX	6 frames (Option 110 only)

Frame Error Add only. Selects the number of frames to be errored in the Structured PDH transmitter.

The corresponding query returns the number of frames errored in discrete form.

:SOURce:DATA:TELEcom:SPDH:ERRor:FRAMe:NERRored?

Returns : <discrete>

:SOURce:DATA:TELEcom:SPDH:ERRor:MFRAMe:NERRored <discrete>

<discrete> =	ONE	1 DS3 Multiframe errored
	TWO	2 DS3 Multiframes errored
	THRee	3 DS3 Multiframes errored
	FOUR	4 DS3 Multiframes errored

This command applies to Option 110 only. Sets the number of DS3 multi-frames to error.

The corresponding query command returns the current setting.

:SOURce:DATA:TELEcom:SPDH:ERRor:MFRAMe:NERRored?

Returns : <discrete>

SOURce subsystem - Transmitter SPDH Test Function Commands

:SOURce:DATA:TELEcom:SPDH:ERRor:EXZ:NUMBer <numeric>

<numeric> = 3 to 16

Sets the number of DS3/DS1 excess zeros sent (Option 110 only). The corresponding query command returns the current setting.

:SOURce:DATA:TELEcom:SPDH:ERRor:EXZ:NUMBer?

Returns : <numeric>

:SOURce:DATA:TELEcom:SPDH:FEAC <discrete>

<discrete> =	OFF	No Action
	ON	Alarm burst switched to continuous
	BURSt	Selected burst length transmitted

Sets the transmitter FEAC action (Option 110 only). Only valid if :SOURce:DATA:TELEcom:TFUNction <discrete> is set to SPDH and :SOURce:DATA:TELEcom:SPDH:DS3:ALARm <discrete> is set to FEAC . If set to 'ON' then the alarm burst will be switched to continuous. If 'BURSt' then the alarm burst length set up will be transmitted. The corresponding query command returns the current setting.

:SOURce:DATA:TELEcom:SPDH:FEAC?

Returns <discrete>

:SOURce:DATA:TELEcom:SPDH:FEAC:BURSt <numeric>

<numeric> = 0 to 15

Sets the transmitter FEAC alarm burst length (Option 110 only). Only valid if :SOURce:DATA:TELEcom:TFUNction <discrete> is set to SPDH and :SOURce:DATA:TELEcom:SPDH:DS3:ALARm <discrete> is set to FEAC. If set to 0 then the alarm burst will be switched to continuous. Any other value (1 to 15) will set the alarm burst length to that value. The corresponding query command returns the current setting.

SOURce subsystem - Transmitter SPDH Test Function Commands

:SOURce:DATA:TELEcom:SPDH:FEAC:BURSt?

Returns : <numeric> = 0 (Indicates continuous)
 1 to 15 (Indicates burst length)

:SOURce:DATA:TELEcom:SPDH:FEAC:CODE <string>

<string> = "nnnnnn" (n = 0,1)

Sets the user configurable section of the FEAC code (Option 110 only). Range "000000" to "111111". The corresponding query command returns the current setting.

:SOURce:DATA:TELEcom:SPDH:FEAC:CODE?

Returns : <string> = "000000" to "111111"

:SOURce:DATA:TELEcom:SPDH:FEAC:LOOPback:ACTion <discrete>

<discrete> =	DS1 Deactivat	Deactivate DS1 Loopback
	DS1 Activat	Activate DS1 Loopback
	DS3Deactivat	Deactivate DS3 Loopback
	DS3Activat	Activate DS3 Loopback

Sets the transmitter FEAC loopback action (Option 110 only). Only valid if :SOURce:DATA:TELEcom:TFUNction <discrete> is set to SPDH and :SOURce:DATA:TELEcom:SPDH:DS3:ALARm <discrete> is set to FEAC. The corresponding query command returns the current setting.

:SOURce:DATA:TELEcom:SPDH:FEAC:LOOPback:ACTion?

Returns : <discrete>

:SOURce:DATA:TELEcom:SPDH:FEAC:LOOPback:MESSAge <numeric>

<numeric> = 0 to 28 Sets the transmitter FEAC DS1 channel for loopback

SOURce subsystem - Transmitter SPDH Test Function Commands

This command only applies when Option 110 is fitted. Only valid if :SOURce:DATA:TELEcom:TFUNction <discrete> is set to SPDH and :SOURce:DATA:TELEcom:SPDH:DS3:ALARm <discrete> is set to FEAC. If set to 0 then ALL will be selected. Any other value (1 to 28) will set the DS1 channel for loopback to that value. The corresponding query command returns the current setting.

:SOURce:DATA:TELEcom:SPDH:FEAC:LOOPback:MESSage?

Returns : <numeric> = 0 (Indicates ALL)
 1 to 28 (Indicates channel number)

:SOURce:DATA:TELEcom:SPDH:FEAC:LOOPback:BURSt <numeric>, <numeric>

<numeric> = 1 to 15 Sets the FEAC loopback command durations
 <numeric> = 1 to 15 Sets the FEAC loopback message durations

This command only applies when Option 110 is fitted. Only valid if :SOURce:DATA:TELEcom:TFUNction <discrete> is set to SPDH and :SOURce:DATA:TELEcom:SPDH:DS3:ALARm <discrete> is set to FEAC. The corresponding query command returns the current setting.

:SOURce:DATA:TELEcom:SPDH:FEAC:LOOPback:BURSt?

Returns : <numeric>, <numeric>

:SOURce:DATA:TELEcom:SPDH:M140:ALARm <discrete>

<discrete> =	NONE	
	LOS	Loss of Signal
	AIS	Alarm Indication Signal
	LOFrame	Loss Of Framing
	RAI	Remote Alarm Indication

Set a 140 Mb/s transmit alarm. Command node :M139 can be used in place of :M140. Activating an alarm is only permitted when :SOURce:DATA:TELEcom:TFUNction <discrete> is set to PDH or PDHPayload,

SOURce subsystem - Transmitter SPDH Test Function Commands

and :SOURce:DATA:TELEcom:SPDH:TFUNction:TYPE <discrete> is set to ERRor.

The corresponding query command returns the current 140 Mb/s transmit alarm as listed above.

:SOURce:DATA:TELEcom:SPDH:M140:ALARm?

Returns: <discrete>

:SOURce:DATA:TELEcom:SPDH:M34:ALARm <discrete>

<discrete> =	NONE	
	LOS	Loss of Signal
	AIS	Alarm Indication Signal
	LOFrame	Loss Of Framing
	RAI	Remote Alarm Indication

Sets a 34Mb/s transmit alarm. Activating an alarm is only permitted when :SOURce:DATA:TELEcom:TFUNction <discrete> is set to PDH or PDHPayload, and :SOURce:DATA:TELEcom:SPDH:TFUNction:TYPE <discrete> is set to ERRor.

The corresponding query command returns the current 34 Mb/s transmit alarm as listed above.

:SOURce:DATA:TELEcom:SPDH:M34:ALARm?

Returns: <discrete>

:SOURce:DATA:TELEcom:SPDH:M8:ALARm <discrete>

<discrete> =	NONE	
	LOS	Loss of Signal
	AIS	Alarm Indication Signal
	LOFrame	Loss Of Framing
	RAI	Remote Alarm Indication

SOURce subsystem - Transmitter SPDH Test Function Commands

Set an 8 Mb/s transmit alarm. Activating an alarm is only permitted when :SOURce:DATA:TELEcom:TFUNction <discrete> is set to PDH or PDHPayload, and :SOURce:DATA:TELEcom:SPDH:TFUNction:TYPE <discrete> is set to ERRor.

The corresponding query command returns the current 8 Mb/s transmit alarm as listed above.

:SOURce:DATA:TELEcom:SPDH:M8:ALARm?

Returns: <discrete>

:SOURce:DATA:TELEcom:SPDH:M2:ALARm <discrete>

<discrete> =	NONE	
	LOS	Loss of Signal
	AIS	Alarm Indication Signal
	LOFrame	Loss Of Framing
	RAI	Remote Alarm Indication
	RMFRame	Remote Multiframe Alarm
	CMFLoss	CAS Multiframe Loss

Set a 2 Mb/s transmit alarm. RMFRame and CMFLoss are only valid when timeslot-16 CAS multiframe has been selected. Activating an alarm is only permitted when :SOURce:DATA:TELEcom:TFUNction is set to PDH or PDHPayload, and :SOURce:DATA:TELEcom:TFUNction:TYPE is set to ERRor.

The corresponding query command returns the current 2 Mb/s transmit alarm as listed above.

:SOURce:DATA:TELEcom:SPDH:M2:ALARm?

Returns: <discrete>

:SOURce:DATA:TELEcom:SPDH:DS3:ALARm <discrete>

<alarm> =	NONE	
	LOS	Loss of signal
	AIS	Alarm Indication Signal

SOURce subsystem - Transmitter SPDH Test Function Commands

OOFrame	Out Of Framing
RAI	Remote Alarm Indication
FEAC	FEAC alarm
IDLE	idle

Applies to Options 110 only. Sets a DS3 transmit alarm. Activating an alarm is only permitted when :SOURce:DATA:TELEcom:TFUNction <discrete> is set to PDH or PDHPayload, and :SOURce:DATA:TELEcom:SPDH:TFUNction:TYPE <discrete> is set to ERRor.

The corresponding query command returns the current DS3 transmit alarm as listed above.

:SOURce:DATA:TELEcom:SPDH:DS3:ALARm?

Returns: <discrete>

:SOURce:DATA:TELEcom:SPDH:DS1:ALARm <discrete>

<discrete> =	NONE	
	LOS	Loss of Signal
	AIS	Alarm Indication Signal
	OOFrame	Out Of Framing
	RAI	Remote Alarm Indication

Applies to Option 110 only. Sets a DS1 transmit alarm. Activating an alarm is only permitted when :SOURce:DATA:TELEcom:TFUNction <discrete> is set to PDH or PDHPayload, and :SOURce:DATA:TELEcom:SPDH:TFUNction:TYPE <discrete> is set to ERRor.

The corresponding query returns the framing in discrete form as listed above.

:SOURce:DATA:TELEcom:SPDH:DS1:ALARm?

Returns: <discrete>

:SOURce:DATA:TELEcom:SPDH:M140:SPARe <string>

<string> = "000" to "111"

SOURce subsystem - Transmitter SPDH Test Function Commands

Set the 140 Mb/s spare bits. This action is only permitted when :SOURce:DATA:TELEcom:TFUNction <discrete> is set to PDH or PDHPayload, and :SOURce:DATA:TELEcom:SPDH:TFUNction:TYPE <discrete> is set to SBITs. Command node :M139 can be used in place of :M140.

The corresponding query command returns the current 140 Mb/s spare bit values.

:SOURce:DATA:TELEcom:SPDH:M140:SPARe?

Returns: <string>

:SOURce:DATA:TELEcom:SPDH:M34:SPARe <string>

<string> = "0" to "1"

Set the 34Mb/s spare bit. This action is only permitted when :SOURce:DATA:TELEcom:TFUNction <discrete> is set to PDH or PDHPayload, and :SOURce:DATA:TELEcom:SPDH:TFUNction:TYPE <discrete> is set to SBITs.

The corresponding query command returns the current 34 Mb/s spare bit value.

:SOURce:DATA:TELEcom:SPDH:M34:SPARe?

Returns: <string>

:SOURce:DATA:TELEcom:SPDH:M8:SPARe <string>

<string> = "0" to "1"

Set the 8 Mb/s spare bit. This action is only permitted when :SOURce:DATA:TELEcom:TFUNction <discrete> is set to PDH or PDHPayload, and :SOURce:DATA:TELEcom:SPDH:TFUNction:TYPE <discrete> is set to SBITs.

The corresponding query command returns the current 8 Mb/s spare bit value.

:SOURce:DATA:TELEcom:SPDH:M8:SPARe?

Returns: <string>

:SOURce:DATA:TELEcom:SPDH:M2:SI <string>

SOURce subsystem - Transmitter SPDH Test Function Commands

<string> = "0" to "1"

Set the 2 Mb/s Spare International bit, valid for non-CRC4 multiframe. This action is only permitted when :SOURce:DATA:TELEcom:TFUNction <discrete> is set to PDH or PDHPayload, and :SOURce:DATA:TELEcom:SPDH:TFUNction:TYPE <discrete> is set to SBITS.

The corresponding query command returns the current 2 Mb/s Spare International bit.

:SOURce:DATA:TELEcom:SPDH:M2:SI?

Returns: <string>

:SOURce:DATA:TELEcom:SPDH:M2:SIE <string>

<string> = "00" to "11"

Set the 2 Mb/s E-bits, valid for CRC4 multiframe. This action is only permitted when :SOURce:DATA:TELEcom:TFUNction <discrete> is set to PDH or PDHPayload, and :SOURce:DATA:TELEcom:SPDH:TFUNction:TYPE <discrete> is set to SBITS.

The corresponding query command returns the current 2 Mb/s E-bits.

:SOURce:DATA:TELEcom:SPDH:M2:SIE?

Returns: <string>

:SOURce:DATA:TELEcom:SPDH:M2:NFAS <string>

<string> = "00000" to "11111"

Set the 2 Mb/s NFAS Sa bits 4 to 8. This action is only permitted when :SOURce:DATA:TELEcom:TFUNction <discrete> is set to PDH or PDHPayload, and :SOURce:DATA:TELEcom:SPDH:TFUNction:TYPE <discrete> is set to SBITS. The command will generate an error if the Sa sequence is active.

The corresponding query command returns the current 2 Mb/s NFAS Sa bit values.

:SOURce:DATA:TELEcom:SPDH:M2:NFAS?

SOURce subsystem - Transmitter SPDH Test Function Commands

Returns: <string>

If the Sa sequence is active, the underlying user-defined value of the affected bit is returned rather than the "X" that appears on the instrument display.

:SOURce:DATA:TELEcom:SPDH:M2:SASequence <boolean>

<boolean> = 0 or OFF
1 or ON

Set the 2 Mb/s NFAS Sa sequence generation ON or OFF, valid for CRC4 multiframe. The sequence that is generated is controlled by :SASequence:PATtern and the bit that it is inserted into is controlled by :SOURce:DATA:TELEcom:SPDH:M2:SASequence:BIT <numeric>. This action is only permitted when :SOURce:DATA:TELEcom:TFUNction <discrete> is set to PDH or PDHPayload, and :SOURce:DATA:TELEcom:SPDH:TFUNction:TYPE <discrete> is set to SBITs.

The corresponding query command returns the current sequence generation state.

:SOURce:DATA:TELEcom:SPDH:M2:SASequence?

Returns: <boolean>

:SOURce:DATA:TELEcom:SPDH:M2:SASequence:PATtern <string>

<string> = "00000000" to "11111111"

Set the 2 Mb/s NFAS Sa sequence pattern. The command will generate an error if the Sa sequence is active.

The corresponding query command returns the current 2 Mb/s NFAS Sa sequence pattern.

:SOURce:DATA:TELEcom:SPDH:M2:SASequence:PATtern?

Returns: <string>

:SOURce:DATA:TELEcom:SPDH:M2:SASequence:BIT <numeric>

<numeric> = 4 to 8

SOURce subsystem - Transmitter SPDH Test Function Commands

Set the bit in the 2 Mb/s NFAS timeslot into which the Sa sequence will be inserted. The command will generate an error if the Sa sequence is active.

The corresponding query command returns the currently selected bit.

:SOURce:DATA:TELEcom:SPDH:M2:SASequence:BIT?

Returns: <numeric>

:SOURce:DATA:TELEcom:SPDH:M2:CASMfm <string>

<string> = "000" to "111"

Set the 2 Mb/s MFAS spare bits 5, 7 and 8. This action is only permitted when :SOURce:DATA:TELEcom:TFUNction <discrete> is set to PDH or PDHPayload, and :SOURce:DATA:TELEcom:SPDH:TFUNction:TYPE <discrete> is set to SBITs.

The corresponding query command returns the current 2 Mb/s MFAS spare bit values.

:SOURce:DATA:TELEcom:SPDH:M2:CASMfm?

Returns: <string>

INPut subsystem

INPut subsystem

This subsystem controls the characteristics of the instrument's input ports.

:INPut:TELEcom:PDH:RATE <discrete>

<discrete> =	M140	140 Mb/s
	M34	34 Mb/s
	M8	8 Mb/s
	M2	2 Mb/s
	K704	704 kb/s

Selects the clock rate for the Unstructured PDH receiver.

The corresponding query returns the clock rate in discrete form, as listed above.

:INPut:TELEcom:PDH:RATE?

Returns : <discrete>

:INPut:TELEcom:PDH:CODE <discrete>

<discrete> =	AMI	8 Mb/s, 2 Mb/s, 704 kb/s
	HDB3	34 Mb/s, 8 Mb/s, 2 Mb/s, 704 kb/s
	CMI	140 Mb/s only

Selects the line code interface for the Unstructured PDH receiver.

The corresponding query returns the line code in discrete form, as listed above.

:INPut:TELEcom:PDH:CODE?

Returns : <discrete>

:INPut:TELEcom:PDH:BALance <discrete>

<discrete> =	UNBalanced	75Ω unbalanced
--------------	------------	----------------

INPut subsystem

BALanced 120Ω balanced

Selects the Unstructured PDH receiver termination levels. BALanced is only valid when :INPut:TELEcom:PDH:RATE <discrete> is set to M2 or K704.

The corresponding query returns the termination level in discrete form, as listed above.

:INPut:TELEcom:PDH:BALance?

Returns : <discrete>

:INPut:TELEcom:PDH:BINary:INTerface <discrete>

<discrete> =	CODed	Non Binary interface
	BINary	Binary interface

Option UH3 only. Selects between coded and binary interfaces.

The corresponding query returns the interface type in discrete form as listed above.

:INPut:TELEcom:PDH:BINary:INTerface?

Returns : <discrete>

:INPut:TELEcom:SPDH:RATE <discrete>

<discrete> =	M140	140 Mb/s (Option UKJ only)
	M34	34 Mb/s
	M8	8 Mb/s (Option UKJ only)
	M2	2 Mb/s
	DS1	1.544 Mb/s (Option 110 only)
	DS3	44.736 Mb/s (Option 110 only)

Sets the input rate for the PDH electrical input port. This command is only valid when :SENSe:DATA:TELEcom:SENSe <discrete> is set to PDH.

The corresponding query returns the clock rate in discrete form, as listed above.

PDH Command Reference

INPut subsystem

:INPut:TELEcom:SPDH:RATE?

Returns : <discrete>

This query is only valid if :SENSe:DATA:TELEcom:SENSe <discrete> is set to PDH.

:INPut:TELEcom:SPDH:CODE <discrete>

<discrete> =	AMI	8 Mb/s, 2 Mb/s
	HDB3	34 Mb/s, 8 Mb/s, 2 Mb/s
	CMI	140 Mb/s only
	B3ZS	DS1
	B8ZS	DS3

Selects the line code interface for the Structured PDH receiver.

The corresponding query returns the line code in discrete form, as listed above.

:INPut:TELEcom:SPDH:CODE?

Returns : <discrete>

:INPut:TELEcom:SPDH:INSert:CODE <discrete>

<discrete> =	AMI	2Mb/s, DS1
	HDB3	2Mb/s only
	B8ZS	DS1 only

Applies to option 110 only.

Selects the Structured PDH insert port interface line code for the transmitter.

The corresponding query returns the line code in discrete form as listed above.

:INPut:TELEcom:SPDH:INSert:CODE?

Returns: <discrete>

PDH Command Reference

INPut subsystem

:INPut:TELEcom:SPDH:EQualisation?

Returns : boolean

INPut subsystem

SENSe subsystem - Receiver Unstructured PDH Settings

GND Ground
AUTO

Requires a PDH Binary option. Selects the receiver binary clock threshold level.

The corresponding query returns the receiver binary clock threshold level in discrete form, as listed above.

:SENSe:DATA:TELEcom:PDH:BINary:THREshold:CLOCK?

Returns : <discrete>

:SENSe:DATA:TELEcom:PDH:BINary:THREshold:EXTClock <discrete>

<discrete> = ECL
 TTL
 GND Ground
 AUTO

Requires a PDH Binary option. Selects the external binary clock threshold level.

The corresponding query returns the external binary clock threshold level in discrete form, as listed above.

:SENSe:DATA:TELEcom:PDH:BINary:THREshold:EXTClock?

Returns : <discrete>

:SENSe:DATA:TELEcom:PDH:BINary:POLarity:CLOCK <discrete>

<discrete> = NORMal
 INVerted

Requires a PDH Binary option. Selects the receiver binary clock polarity type.

The corresponding query returns the receiver binary clock polarity type in discrete form, as listed above.

:SENSe:DATA:TELEcom:PDH:BINary:POLarity:CLOCK?

SENSe subsystem - Receiver Unstructured PDH Settings

Returns : <discrete>

:SENSe:DATA:TELEcom:PDH:BINary:POLarity:EXTClock <discrete>

<discrete> = NORMAL
 INVerted

Requires a PDH Binary option. Selects the external binary clock polarity type.

The corresponding query returns the external binary clock polarity type in discrete form, as listed above.

:SENSe:DATA:TELEcom:PDH:BINary:POLarity:EXTClock?

Returns : <discrete>

:SENSe:DATA:TELEcom:PDH:BINary:THReshold:DATA <discrete>

<discrete> = ECL
 TTL
 GND Ground

Requires a PDH Binary option. Selects the receiver binary data threshold level.

The corresponding query returns the receiver binary data threshold level in discrete form, as listed above.

:SENSe:DATA:TELEcom:PDH:BINary:THReshold:DATA?

Returns : <discrete>

:SENSe:DATA:TELEcom:PDH:BINary:POLarity:DATA <discrete>

<discrete> = NORMAL
 INVerted

Requires a PDH Binary option. Selects the receiver binary data polarity type.

The corresponding query returns the receiver binary data polarity type in discrete form, as listed above.

SENSe subsystem - Receiver Unstructured PDH Settings

:SENSe:DATA:TELEcom:PDH:BINary:POLarity:DATA?

Returns : <discrete>

:SENSe:DATA:TELEcom:PDH:ATYPe <discrete>

<discrete>= G821
M2100

Sets the Unstructured PDH analysis display mode.

The corresponding query returns the analysis display mode in discrete form as listed above.

:SENSe:DATA:TELEcom:PDH:ATYPe?

Returns: <discrete>

SENSe subsystem - Receiver Structured PDH Settings

SENSe subsystem - Receiver Structured PDH Settings

:SENSe:DATA:TELecom:SPDH:PAATtern <discrete>

<discrete> =	PRBS9	2^9-1
	PRBS11	$2^{11}-1$
	PRBS15	$2^{15}-1$
	PRBS20	$2^{20}-1$
	QRSS	$2^{20}-1$ with 14 zero limit (DS1 with Option 110 only)
	PRBS23	$2^{23}-1$
	AZERo	All Zero's
	AONE	All One's
	STRess	3-in-24 stress pattern (DS1 with Option 110 only)
	P1010	Word 1010
	P1000	Word 1000
	UWORD	16 Bit User Word
	LIVE	Live Traffic

Selects the Structured PDH receiver data pattern. If UWORD is selected the word is set using :SENSe:DATA:TELecom:SPDH:UWORD <string>.

The corresponding query returns the reference data pattern in discrete form, as listed above.

:SENSe:DATA:TELecom:SPDH:PAATtern?

Returns : <discrete>

SENSe subsystem - Receiver Structured PDH Settings

:SENSe:DATA:TELEcom:SPDH:UWORD <string>

Sets the user word pattern, of the Structured PDH receiver, in the range "00000000 00000000" to "1111111111111111".

The corresponding query returns the user word pattern as a string.

:SENSe:DATA:TELEcom:SPDH:UWORD?

Returns : <string>

:SENSe:DATA:TELEcom:SPDH:PRBS:POLarity <discrete>

<discrete> =	NORMAL	Non CCITT
	INVERTed	CCITT

Selects the Structured PDH receiver PRBS pattern polarity.

The corresponding query returns the PRBS pattern polarity in discrete form as listed above.

:SENSe:DATA:TELEcom:SPDH:PRBS:POLarity?

Returns : <discrete>

:SENSe:DATA:TELEcom:SPDH:PAYLoad:TYPE <discrete>

<discrete> =	UNFRamed	No framing
	FRAMed	8, 34 & 140 Mb/s
	PCM30	2 Mb/s Only
	PCM31	2 Mb/s Only
	PCM30CRC	2 Mb/s Only
	PCM31CRC	2 Mb/s Only
	D4	DS1 only (Option 110 only)
	ESF	DS1 only (Option 110 only)
	SLC96	DS1 only (Option 110 only)
	M13	DS3 only (Option 110 only)

SENSe subsystem - Receiver Structured PDH Settings

CBIT

DS3 only (Option 110 only)

Selects the Structured PDH receiver interface rate framing.

Note: This command is not backwards compatible, to set the framing type to be structured, use the command :SENSe:DATA:TELEcom:SPDH:PAYLoad:STRUcture <discrete>.

The corresponding query returns the interface frame type in discrete form, as listed above.

:SENSe:DATA:TELEcom:SPDH:PAYLoad:TYPE?

Returns : <discrete>

:SENSe:DATA:TELEcom:SPDH:PAYLoad:STRUcture <discrete>

<discrete> =	UNSTRUctured	All rates
	STRUctured	All framed formats

Selects whether or not the PDH receiver is to have any further structure or not.

The corresponding query returns the type in discrete form as listed above.

:SENSe:DATA:TELEcom:SPDH:PAYLoad:STRUcture?

Returns: <discrete>

:SENSe:DATA:TELEcom:SPDH:BINary:FREQ <discrete>

<discrete> =	RXCLk	Received clock
	EXTCLk	External Clock

Requires a PDH Binary option. Selects the binary clock source. If RXCLk is selected, further selections of

:SENSe:DATA:TELEcom:SPDH:BINary:THREshold:CLOCK <discrete> and :SENSe:DATA:TELEcom:SPDH:BINary:POLarity:CLOCK <discrete> are required.

The corresponding query returns the binary clock source in discrete form as listed above.

SENSe subsystem - Receiver Structured PDH Settings

:SENSe:DATA:TELEcom:SPDH:BINary:FREQ?

Returns : <discrete>

:SENSe:DATA:TELEcom:SPDH:BINary:THReshold:CLOCK <discrete>

<discrete> = ECL
TTL
GND Ground
AUTO

Requires a PDH Binary option. Selects the receiver binary clock threshold level.

The corresponding query returns the receiver binary clock threshold level in discrete form, as listed above.

:SENSe:DATA:TELEcom:SPDH:BINary:THReshold:CLOCK?

Returns : <discrete>

:SENSe:DATA:TELEcom:SPDH:BINary:THReshold:EXTClock <discrete>

<discrete> = ECL
TTL
GND Ground
AUTO

Requires a PDH Binary option. Selects the external binary clock threshold level.

The corresponding query returns the external binary clock threshold level in discrete form, as listed above.

:SENSe:DATA:TELEcom:SPDH:BINary:THReshold:EXTClock?

Returns : <discrete>

:SENSe:DATA:TELEcom:SPDH:BINary:POLarity:CLOCK <discrete>

<discrete> = NORMAL

SENSe subsystem - Receiver Structured PDH Settings

INVerted

Requires a PDH Binary option. Selects the receiver binary clock polarity type.

The corresponding query returns the receiver binary clock polarity type in discrete form, as listed above.

:SENSe:DATA:TELecom:SPDH:BINary:POLarity:CLOCK?

Returns : <discrete>

:SENSe:DATA:TELecom:SPDH:BINary:POLarity:EXTClock <discrete>

<discrete> = NORMAL

INVerted

Requires a PDH Binary option. Selects the external binary clock polarity type.

The corresponding query returns the external binary clock polarity type in discrete form, as listed above.

:SENSe:DATA:TELecom:SPDH:BINary:POLarity:EXTClock?

Returns : <discrete>

:SENSe:DATA:TELecom:SPDH:BINary:THREshold:DATA <discrete>

<discrete> = ECL

TTL

GND Ground

Requires a PDH Binary option. Selects the receiver binary data threshold level.

The corresponding query returns the receiver binary data threshold level in discrete form, as listed above.

:SENSe:DATA:TELecom:SPDH:BINary:THREshold:DATA?

Returns : <discrete>

SENSe subsystem - Receiver Structured PDH Settings

:SENSe:DATA:TELEcom:SPDH:BINary:POLarity:DATA <discrete>

<discrete> = NORMal

 INVerted

Requires a PDH Binary option. Selects the receiver binary data polarity type.

The corresponding query returns the receiver binary data polarity type in discrete form, as listed above.

:SENSe:DATA:TELEcom:SPDH:BINary:POLarity:DATA?

Returns : <discrete>

SENSe subsystem - Receiver SPDH Test Signal Settings Commands

SENSe subsystem - Receiver SPDH Test Signal Settings Commands

:SENSe:DATA:TELEcom:SPDH:TSIGnal:RATE <discrete>

<discrete> =	M34	34 Mb/s
	M8	8 Mb/s
	M2	2 Mb/s
	K64	64 kb/s
	K64XN	Nx64 kb/s
	DS1	DS1 rate (Option 110 only)
	K56	56 kb/s (Option 110 only)
	K56XN	N x 56 kb/s (Option 110 only)

Selects the Structured PDH receiver test signal rate.

The corresponding query returns the test signal rate in discrete form as listed above.

:SENSe:DATA:TELEcom:SPDH:TSIGnal:RATE?

Returns : <discrete>

:SENSe:DATA:TELEcom:SPDH:TSIGnal:PAYLoad <discrete>

<discrete> =	UNFRamed	2, 8 & 34 Mb/s
	FRAMed	8 & 34 Mb/s
	PCM30	2 Mb/s
	PCM31	2 Mb/s
	PCM30CRC	2 Mb/s
	PCM31CRC	2 Mb/s
	DM2	2 Mb/s Drop

SENSe subsystem - Receiver SPDH Test Signal Settings Commands

D4	DS1 (Option 110 only)
ESF	DS1 (Option 110 only)
SLC96	DS1 (Option 110 only)
DDS1	Drop DS1 (Option 110 only)

Selects the Structured PDH receiver test signal framing.

The corresponding query returns the framing in discrete form as listed above.

:SENSe:DATA:TELEcom:SPDH:TSIGnal:PAYLoad?

Returns : <discrete>

:SENSe:DATA:TELEcom:SPDH:TSIGnal:TRIButary:M34 <discrete>

<discrete> =
TRIB1
TRIB2
TRIB3
TRIB4

Selects the Structured PDH receiver 34 Mb/s tributary test signal.

The corresponding query returns the 34 Mb/s tributary test signal in discrete form.

:SENSe:DATA:TELEcom:SPDH:TSIGnal:TRIButary:M34?

Returns : <discrete>

:SENSe:DATA:TELEcom:SPDH:TSIGnal:TRIButary:M8 <discrete>

<discrete> =
TRIB1
TRIB2
TRIB3
TRIB4

Selects the Structured PDH receiver 8 Mb/s tributary test signal.

SENSe subsystem - Receiver SPDH Test Signal Settings Commands

The corresponding query returns the 8 Mb/s tributary test signal in discrete form.

:SENSe:DATA:TELEcom:SPDH:TSIGnal:TRIButary:M8?

Returns : <discrete>

:SENSe:DATA:TELEcom:SPDH:TSIGnal:TRIButary:M2 <discrete>

<discrete> = TRIB1
 TRIB2
 TRIB3
 TRIB4

Selects the Structured PDH receiver 2 Mb/s tributary test signal.

The corresponding query returns the 2 Mb/s tributary test signal in discrete form.

:SENSe:DATA:TELEcom:SPDH:TSIGnal:TRIButary:M2?

Returns : <discrete>

:SENSe:DATA:TELEcom:SPDH:TSIGnal:TRIButary:DS1 <discrete>

<discrete> = TRIB1
 TRIB2
 TRIB3
 TRIB4

Selects the Structured PDH receiver DS1 tributary test signal. Option 110 only.

The corresponding query returns the tributary in discrete from as listed above.

:SENSe:DATA:TELEcom:SPDH:TSIGnal:TRIButary:DS1?

Returns: <discrete>

SENSe subsystem - Receiver SPDH Test Signal Settings Commands

:SENSe:DATA:TELEcom:SPDH:TSIGnal:TRIButary:DS2 <discrete>

<discrete> =	TRIB1
	TRIB2
	TRIB3
	TRIB4
	TRIB5
	TRIB6
	TRIB7

Selects the Structured PDH receiver DS2 tributary test signal. Option 110 only.

The corresponding query returns the tributary in discrete form as listed above.

:SENSe:DATA:TELEcom:SPDH:TSIGnal:TRIButary:DS2?

Returns: <discrete>

PDH Command Reference

SENSe subsystem - Receiver SPDH Test Signal Settings Commands

In the following block of commands where an optional node has been added, the command replaces the original command which had no optional node.

:SENSe:DATA:TELEcom:SPDH:TSIGNal:TSLot:M2:K64 <numeric>

<numeric> = 1 to 31 PCM31 & PCM31CRC
 1 to 15 & 17 to 31 PCM30 & PCM30CRC

Selects the Structured PDH receiver 64 kb/s timeslot.

The corresponding query returns the 64 kb/s timeslot in numeric form.

:SENSe:DATA:TELEcom:SPDH:TSIGNal:TSLot:M2:K64?

Returns : <numeric>

:SENSe:DATA:TELEcom:SPDH:TSIGNal:TSLot:M2:K64XN <string>

<string> = 31 bit binary string

Selects the 64XN kb/s timeslots of the 2Mb/s test signal. a "1" in the nth position signifies selection of timeslot n. A "0" signifies deselection eg. to select timeslots 1,8,15,22,29 "1000000100000010000001000000100".

The corresponding query returns the 64XN kb/s timeslot as a 31 bit binary string.

:SENSe:DATA:TELEcom:SPDH:TSIGNal:TSLot:M2:K64XN?

Returns : <string>

:SENSe:DATA:TELEcom:SPDH:TSIGNal:TSLot:DS1:K56 <numeric>

<numeric> 1 to 24 Any framing (Option 110 only)

Selects the PDH receiver 56kb/s timeslot.

The corresponding query returns the 56kb/s timeslot in numeric form.

:SENSe:DATA:TELEcom:SPDH:TSIGNal:TSLot:DS1:K56?

Returns: <numeric>

SENSe subsystem - Receiver SPDH Test Signal Settings Commands

:SENSe:DATA:TELEcom:SPDH:TSIGnal:TSLot:DS1:K64 <numeric>

<numeric> 1 to 24 Any framing (Option 110 only)

Selects the PDH receiver 64kb/s timeslot.

The corresponding query returns the 64kb/s timeslot in numeric form.

:SENSe:DATA:TELEcom:SPDH:TSIGnal:TSLot:DS1:K64?

Returns: <numeric>

:SENSe:DATA:TELEcom:SPDH:TSIGnal:TSLot:DS1:K64XN <string>

<string> = 24 bit string (Option 110 only)

Selects the 64XN kb/s timeslots of the DS1 signal. a "1" in the nth position signifies selection of timeslot n. A "0" signifies deselection eg. to select timeslots 1,8,15,22 "100000010000001000000100".

The corresponding query returns the 64XNkb/s timeslot as a 24 bit binary string.

:SENSe:DATA:TELEcom:SPDH:TSIGnal:TSLot:DS1:K64XN? <string>

Returns: <string>

:SENSe:DATA:TELEcom:SPDH:TSIGnal:TSLot:DS1:K56XN <string>

<string> = 24 bit string (Option 110 only)

Selects the 56XN kb/s timeslots of the DS1 signal. a "1" in the nth position signifies selection of timeslot n. A "0" signifies deselection eg. to select timeslots 1,8,15,22 "100000010000001000000100".

The corresponding query returns the 64XN kb/s timeslot as a 24 bit binary string.

:SENSe:DATA:TELEcom:SPDH:TSIGnal:TSLot:DS1:K56XN? <string>

Returns: <string>

SENSe subsystem - Receiver SPDH Test Function Commands

SENSe subsystem - Receiver SPDH Test Function Commands

:SENSe:DATA:TELEcom:TFUNction:SDISruption <discrete>

<discrete>= OFF

ON

Sets the receiver service disruption mode. This command is only valid with option 110 fitted

The corresponding query returns the service disruption mode setting in discrete form as listed above.

:SENSe:DATA:TELEcom:TFUNction:SDISruption?

Returns: <discrete>

PDH Command Reference
SENSe subsystem - Analysis Control

SENSe subsystem - Analysis Control

:SENSe:DATA:TELeCom:SPDH:ANALysis:M2110 <discrete>

<discrete> =	PALlocation	Path Allocation
	USER	User Defined

Selects the structured PDH M.2110 threshold control source.

The corresponding query command returns the current control source in discrete form as listed above.

:SENSe:DATA:TELeCom:SPDH:ANALysis:M2110?

Returns : <discrete>

:SENSe:DATA:TELeCom:SPDH:ANALysis:M2110:PATH <discrete>

<discrete> =	SECTion	Multiplex Section Layer
	HIGH	High Order Path
	LOW	Low Order Path
	M140	140 Mb/s path
	M34	34 Mb/s path
	M8	8 Mb/s path
	M2	2 Mb/s path
	DS3	DS3 path
	DS1	DS1 path
	K64	64 Kb/s path
	K56	56 Kb/s path

Selects the path layer for analysis by the M.2110 and M.2120 analysis functions. The instrument measures and records all paths for M.2100 and M.2101

SENSe subsystem - Analysis Control

simultaneously, but only one path is measured and analysed for M.2110 and M.2120. This command selects that path.

The corresponding query returns the current path under test in discrete form as listed above.

:SENSe:DATA:TELEcom:SPDH:ANALysis:M2110:PATH?

Returns: <discrete>

:SENSe:DATA:TELEcom:SPDH:ANALysis:M2110 :PALlocation <numeric>

<numeric> = 0.5 to 63 Percentage

Sets the Structured PDH M2110 path allocation percentage.

The corresponding query returns the current path allocation percentage in numeric form.

:SENSe:DATA:TELEcom:SPDH:ANALysis:M2110: PALlocation?

Returns : <numeric>

**:SENSe:DATA:TELEcom:SPDH:ANALysis:M2110:USER:ESECond
<discrete>, <numeric>**

<discrete> =	S1H2	S1, 2 Hours
	S2H2	S2, 2 Hours
	S1D1	S1, 24 Hours
	S2D1	S2 24 Hours
	S1D7	S1, 7 Days
	S1M15	S1, 15 Minutes
	S2M15	S2, 15 Minutes
	S1H1	S1, 1 Hour
	S2H1	S2, 1 Hour
<numeric> =	0 to 90	S1M15 & S2M15

SENSe subsystem - Analysis Control

0 to 360	S1H1 & S2H1
0 to 720	S1H2 & S2H2
0 to 8640	S1D1 & S2D1
0 to 60480	S1D7

Sets the Structured PDH user programmable M.2110 Error Second thresholds. The corresponding query returns the selected M.2110 Error Second threshold in numeric form.

:SENSe:DATA:TELEcom:SPDH:ANALysis:M2110:USER: ESECond?
<discrete>

Returns : <numeric>

:SENSe:DATA:TELEcom:SPDH:ANALysis:M2110:USER: SESecond
<discrete>, <numeric>

<discrete> =	S1H2	S1, 2 Hours
	S2H2	S2, 2 Hours
	S1D1	S1, 24 Hours
	S2D1	S2 24 Hours
	S1D7	S1, 7 Days
	S1M15	S1, 15 Minutes
	S2M15	S2, 15 Minutes
	S1H1	S1, 1 Hour
	S2H1	S2, 1 Hour
	<numeric> =	0 to 90
0 to 360		S1H1 & S2H1
0 to 720		S1H2 & S2H2
0 to 8640		S1D1 & S2D1
0 to 60480		S1D7

SENSe subsystem - Analysis Control

Sets the Structured PDH user programmable M.2110 Severely Errored Seconds thresholds.

The corresponding query returns the selected user programmable M.2110 Severely Errored Seconds threshold in numeric form.

:SENSe:DATA:TELEcom:SPDH:ANALysis:M2110:USER: SESecond? <discrete>

Returns : <numeric>

:SENSe:DATA:TELEcom:SPDH:ANALysis:M2120 <discrete>

<discrete> =	PALlocation	Path Allocation
	USER	User Defined

Selects the Structured PDH M.2120 threshold control source.

The corresponding query returns the current control source in discrete form.

:SENSe:DATA:TELEcom:SPDH:ANALysis:M2120?

Returns : <discrete>

:SENSe:DATA:TELEcom:SPDH:ANALysis:M2120:MFACTOR <numeric>

<numeric> = 50 to 150 % Maintenance Factor

Sets the Structured PDH M.2120 maintenance factor percentage.

The corresponding query returns the current maintenance factor value in numeric form.

:SENSe:DATA:TELEcom:SPDH:ANALysis:M2120:MFACTOR?

Returns : <numeric>

:SENSe:DATA:TELEcom:SPDH:ANALysis:M2120:USER: ESECond <discrete>, <numeric>

<discrete> =	TR1	15 Minute period
	TR2	24 Hour period

PDH Command Reference

SENSe subsystem - Analysis Control

<numeric> =	0 to 900	TR1
	0 to 86400	TR2

Sets the Structured PDH user programmable M.2120 Error Seconds thresholds.

The corresponding query returns the selected user programmable M.2120 Error Second threshold in numeric form.

:SENSe:DATA:TELEcom:SPDH:ANALysis:M2120:USER: ESECond?
<discrete>

Returns : <numeric>

:SENSe:DATA:TELEcom:SPDH:ANALysis:M2120:USER: SESecond
<discrete>, <numeric>

<discrete> =	TR1	15 Minute period
	TR2	24 Hour period
<numeric> =	0 to 900	TR1
	0 to 86400	TR2

Sets the Structured PDH user programmable M.2120 Severely Errored Seconds thresholds.

The corresponding query returns the selected user programmable M.2120 Severely Errored Seconds threshold in numeric form.

:SENSe:DATA:TELEcom:SPDH:ANALysis:M2120:USER: SESecond?
<discrete>

Returns : <numeric>

SENSe subsystem - Alarm Scan Control

SENSe subsystem - Alarm Scan Control

:SENSe:DATA:TELEcom:SPDH:ASCan <boolean>

<boolean> =	0 or OFF	Stop the current alarm scan
	1 or ON	Start a new alarm scan

Option UKJ, UKL only. Start/Stop the structured PDH alarm scan. The corresponding query returns the alarm scan state as 0 or 1.

:SENSe:DATA:TELEcom:SPDH:ASCan?

Returns : <boolean> 0 or 1

SENSe subsystem - SPDH Round Trip Delay Control

SENSe subsystem - SPDH Round Trip Delay Control

:SENSe:DATA:TELecom:SPDH:RTDelay <boolean>

<boolean> = 0 or OFF Stop the round trip delay measurement

1 or ON Start a new round trip delay measurement

Option UKJ, UKL only. Start/Stop the structured PDH round trip delay measurement.

The corresponding query returns the round trip delay state as 0 or 1.

:SENSe:DATA:TELecom:SPDH:RTDelay?

Returns : <boolean> 0 or 1

SENSe subsystem - Result Returning Commands

Unstructured PDH Short Term Results

:SENSe:DATA? <"result">

Result =	"ECOut:PDH:STERm:BIT"	Bit error count
	"ERATio:PDH:STERm:BIT"	Bit error ratio
	"ECOut:PDH:STERm:CODE"	Code error count
	"ERATio:PDH:STERm:CODE"	Code error ratio
	"ECOut:PDH:STERm:FAS"	FAS error count
	"ERATio:PDH:STERm:FAS"	FAS error ratio
	"ECOut:PDH:STERm:CRC"	FAS CRC error count
	"ERATio:PDH:STERm:CRC"	FAS CRC error ratio
	"ECOut:PDH:STERm:REBE"	FAS REBE error count
	"ERATio:PDH:STERm:REBE"	FAS REBE error ratio

Unstructured PDH Cumulative Results

:SENSe:DATA? <"result">

Result =	"ECOut:PDH:BIT"	Bit error count
	"ERATio:PDH:BIT"	Bit error ratio
	"ECOut:PDH:CODE"	Code error count
	"ERATio:PDH:CODE"	Code error ratio
	"ECOut:PDH:FAS"	FAS error count
	"ERATio:PDH:FAS"	FAS error ratio
	"ECOut:PDH:REBE"	FAS REBE error count

PDH Command Reference

SENSe subsystem - Result Returning Commands

"ERATio:PDH:REBE"	FAS REBE error ratio
"ECOunt:PDH:CRC"	FAS CRC error count
"ERATio:PDH:CRC"	FAS CRC error ratio

Unstructured PDH and Payload G.821 Analysis Results

:SENSe:DATA? <"result">

Result = "ECOunt:PDH:BIT"	Error Count
"ESEConds:PDH:BIT:ANALysis"	Error Seconds
"PESeconds:PDH:BIT:ANALysis"	% Error Seconds
"PESD:PDH:BIT:ANALysis"	% Error Seconds (Annex D)
"EFSeconds:PDH:BIT:ANALysis"	Error Free Seconds
"PEFSeconds:PDH:BIT:ANALysis"	% Error Free Seconds
"SESeconds:PDH:BIT:ANALysis"	Severely Errored Seconds
"PSESeconds:PDH:BIT:ANALysis"	% Severely Errored Seconds
"UASeconds:PDH:BIT:ANALysis"	Unavailable Seconds
"PUASeconds:PDH:BIT:ANALysis"	% Unavailable Seconds
"DMINutes:PDH:BIT:ANALysis"	Degraded Minutes
"PDMINutes:PDH:BIT:ANALysis"	% Degraded Minutes
"ESEConds:PDH:CODE:ANALysis"	Code errored seconds

Unstructured PDH M.2100 Analysis Results

:SENSe:DATA? <"result">

Result = "ESEConds:PDH:TRANsmit:ANALysis:M2100"	TX error seconds
"ESEConds:PDH:RECeive:ANALysis:M2100"	RX error seconds
"SESeconds:PDH:TRANsmit:ANALysis:M2100"	TX severely errored seconds
"SESeconds:PDH:RECeive:ANALysis:M2100"	RX severely errored seconds

SENSe subsystem - Result Returning Commands

"UASeconds:PDH:TRANsmit:ANALysis:M2100" TX unavailable seconds
 "UASeconds:PDH:RECeive:ANALysis:M2100" RX unavailable seconds

Unstructured PDH FAS Error Analysis Results

:SENSe:DATA? <"result">

Result =	"ECOUNT:PDH:FAS"	Error count
	"ESECONDS:PDH:FAS:ANALYSIS"	Error Seconds
	"PESECONDS:PDH:FAS:ANALYSIS"	% Error Seconds
	"EFSECONDS:PDH:FAS:ANALYSIS"	Error Free Seconds
	"PEFSECONDS:PDH:FAS:ANALYSIS"	% Error Free Seconds
	"SESECONDS:PDH:FAS:ANALYSIS"	Severely Errored Seconds
	"PSESECONDS:PDH:FAS:ANALYSIS"	% Severely Errored Seconds
	"UASECONDS:PDH:FAS:ANALYSIS"	Unavailable Seconds
	"PUASECONDS:PDH:FAS:ANALYSIS"	% Unavailable Seconds
	"DMINUTES:PDH:FAS:ANALYSIS"	Degraded Minutes
	"PDMINUTES:PDH:FAS:ANALYSIS"	% Degraded Minutes
	"ESECONDS:PDH:CODE:ANALYSIS"	Code-errored seconds

Unstructured PDH CRC Error Analysis Results

:SENSe:DATA? <"result">

Result =	"ECOUNT:PDH:CRC"	Error Count
	"ESECONDS:PDH:CRC:ANALYSIS"	Error Seconds
	"PESECONDS:PDH:CRC:ANALYSIS"	% Error Seconds
	"EFSECONDS:PDH:CRC:ANALYSIS"	Error Free Seconds
	"PEFSECONDS:PDH:CRC:ANALYSIS"	% Error Free Seconds
	"SESECONDS:PDH:CRC:ANALYSIS"	Severely Errored Seconds

SENSe subsystem - Result Returning Commands

"PSECONDS:PDH:CRC:ANALYSIS"	% Severely Errored Seconds
"UASECONDS:PDH:CRC:ANALYSIS"	Unavailable Seconds
"PUASECONDS:PDH:CRC:ANALYSIS"	% Unavailable Seconds
"DMINUTES:PDH:CRC:ANALYSIS"	Degraded Minutes
"PDMINUTES:PDH:CRC:ANALYSIS"	% Degraded Minutes
"ESECONDS:PDH:CODE:ANALYSIS"	Code-errored seconds

Unstructured PDH REBE Error Analysis Results

:SENSe:DATA? <"result">

Result =	"ECOUNT:PDH:REBE"	Error Count
	"ESECONDS:PDH:REBE:ANALYSIS"	Error Seconds
	"PESECONDS:PDH:REBE:ANALYSIS"	% Error Seconds
	"EFSECONDS:PDH:REBE:ANALYSIS"	Error Free Seconds
	"PEFSECONDS:PDH:REBE:ANALYSIS"	% Error Free Seconds
	"SESECONDS:PDH:REBE:ANALYSIS"	Severely Errored Seconds
	"PSESECONDS:PDH:REBE:ANALYSIS"	% Severely Errored Seconds
	"UASECONDS:PDH:REBE:ANALYSIS"	Unavailable Seconds
	"PUASECONDS:PDH:REBE:ANALYSIS"	% Unavailable Seconds
	"DMINUTES:PDH:REBE:ANALYSIS"	Degraded Minutes
	"PDMINUTES:PDH:REBE:ANALYSIS"	% Degraded Minutes
	"ESECONDS:PDH:CODE:ANALYSIS"	Code-errored seconds

Unstructured PDH Alarm Seconds Results

:SENSe:DATA? <"result">

Result =	"ASECONDS:PLOSS"	Power loss
	"ASECONDS:PDH:LOS"	Loss Of Signal

SENSe subsystem - Result Returning Commands

"ASEConds:PDH:LOF"	Frame Loss
"ASEConds:PDH:AIS"	AIS
"ASEConds:PDH:MFM"	Multiframe Loss
"ASEConds:PDH:RAI"	Remote Alarm
"ASEConds:PDH:RMFRame"	Remote Multiframe Alarm
"ASEConds:PDH:PSLoss"	Pattern Sync Loss

Frequency Results (PDH and SPDH)

:SENSe:DATA? <"result">

Result =	"FREQuency:PDH"	RX UPDH clock measured over 16s
	"FOFPpm:PDH"	RX UPDH clock offset in ppm measured over 16s
	"FOFHz:PDH"	RX UPDH clock offset in Hz measured over 16s
	"FREQuency:KHZ:PDH"	RX UPDH clock in kHz measured over 1s
	"FOFHz:KHZ:PDH"	RX UPDH clock offset in kHz measured over 1s
	"FREQuency:SPDH"	RX SPDH clock frequency
	"FOFPpm:SPDH"	RX SPDH clock offset in ppm
	"FOFHz:SPDH"	RX SPDH clock offset in Hz

Structured PDH Short Term Results

:SENSe:DATA?<"result">

Result =	"ECOunt:SPDH:STERm:BIT"	Bit error count
	"ERATio:SPDH:STERm:BIT"	Bit error ratio
	"ECOunt:SPDH:STERm:CODE"	Code error count
	"ERATio:SPDH:STERm:CODE"	Code error ratio

PDH Command Reference

SENSE subsystem - Result Returning Commands

"ECOut:SPDH:STERm:M2:FAS"	2 Mb/s FAS error count
"ERATio:SPDH:STERm:M2:FAS"	2 Mb/s FAS error ratio
"ECOut:SPDH:STERm:M8:FAS"	8 Mb/s FAS error count
"ERATio:SPDH:STERm:M8:FAS"	8 Mb/s FAS error ratio
"ECOut:SPDH:STERm:M34:FAS"	34 Mb/s FAS error count
"ERATio:SPDH:STERm:M34:FAS"	34 Mb/s FAS error ratio
"ECOut:SPDH:STERm:EMBip"	PDH M34 EM-BIP error count *
"ERATio:SPDH:STERm:EMBip"	PDH M34 EM-BIP error count *
"ECOut:SPDH:STERm:M140:FAS"	140 Mb/s FAS error count
"ERATio:SPDH:STERm:M140:FAS"	140 Mb/s FAS error ratio
"ECOut:SPDH:STERm:FEBE"	PDH FEBE error count *
"ERATio:SPDH:STERm:FEBE"	PDH FEBE error ratio
"ECOut:SPDH:STERm:PBITs"	PDH DS3 P-BITs error count *
"ERATio:SPDH:STERm:PBITs"	PDH DS3 P-BITs error ratio *
"ECOut:SPDH:STERm:CPBits"	PDH DS3 CP-Bits error count *
"ERATio:SPDH:STERm:CPBits"	PDH DS3 CP-Bits error ratio *
"ECOut:SPDH:STERm:DS1:FAS"	PDH Frame short term error count *
"ERATio:SPDH:STERm:DS1:FAS"	PDH Frame short term error ratio
"ECOut:SPDH:STERm:DS3:FAS"	PDH Frame short term error count *
"ERATio:SPDH:STERm:DS3:FAS"	PDH Frame short term error ratio *
"ECOut:SPDH:STERm:CRC"	CRC error count
"ERATio:SPDH:STERm:CRC"	CRC error ratio
"ECOut:SPDH:STERm:REBE"	REBE error count
"ERATio:SPDH:STERm:REBE"	REBE error ratio

* Option UKZ and 110 only

PDH Command Reference
SENSe subsystem - Result Returning Commands

Structured PDH Cumulative Results

:SENSe:DATA? <"result">

Result =	"ECOunt:SPDH:BIT"	Bit error count
	"ERATio:SPDH:BIT"	Bit error ratio
	"ECOunt:SPDH:CODE"	Code error count
	"ERATio:SPDH:CODE"	Code error ratio
	"ECOunt:SPDH:M2:FAS"	2 Mb/s FAS error count
	"ERATio:SPDH:M2:FAS"	2 Mb/s FAS error ratio
	"ECOunt:SPDH:M8:FAS"	8 Mb/s FAS error count
	"ERATio:SPDH:M8:FAS"	8 Mb/s FAS error ratio
	"ECOunt:SPDH:M34:FAS"	34 Mb/s FAS error count
	"ERATio:SPDH:M34:FAS"	34 Mb/s FAS error ratio
	"ECOunt:SPDH:EMBip"	PDH M34 EM-BIP error count *
	"ERATio:SPDH:EMBip"	PDH M34 EM-BIP error ratio *
	"ECOunt:SPDH:M140:FAS"	140 Mb/s FAS error count
	"ERATio:SPDH:M140:FAS"	140 Mb/s FAS error ratio
	"ECOunt:SPDH:FEBE"	PDH / DS _n FEBE error count *
	"ERATio:SPDH:FEBE"	PDH / DS _n FEBE error ratio *
	"ECOunt:SPDH:PBITs"	DS3 P-BITs error count *
	"ERATio:SPDH:PBITs"	PDH DS3 P-BITs error ratio *
	"ECOunt:SPDH:CPBits"	DS3 CP-Bits error count *
	"ERATio:SPDH:CPBits"	DS3 CP-Bits error ratio *
	"ECOunt:SPDH:DS1:FAS"	DS1 Frame error count *
	"ERATio:SPDH:DS1:FAS"	DS1 Frame error ratio *
	"ECOunt:SPDH:DS3:FAS"	DS3 Frame error count *
	"ERATio:SPDH:DS3:FAS"	DS3 Frame error ratio *
	"ECOunt:SPDH:REBE"	REBE error count

SENSe subsystem - Result Returning Commands

"ERATio:SPDH:REBE"	REBE error ratio
"ECount:SPDH:CRC"	CRC error count
"ERATio:SPDH:CRC"	CRC error ratio

* Option UKZ and 110only

Structured PDH and Payload G.821 Analysis Results

:SENSe:DATA? <"result">

Result = "ECount:SPDH:BIT"	Error Count
"ESEconds:SPDH:BIT:ANALysis"	Error Seconds
"PESeconds:SPDH:BIT:ANALysis"	% Error Seconds
"PESD:SPDH:BIT:ANALysis"	% Error Seconds (Annex D)
"EFSeconds:SPDH:BIT:ANALysis"	Error Free Seconds
"PEFSeconds:SPDH:BIT:ANALysis"	% Error Free Seconds
"SESeconds:SPDH:BIT:ANALysis"	Severely Errored Seconds
"PSESeconds:SPDH:BIT:ANALysis"	% Severely Errored Seconds
"UASeconds:SPDH:BIT:ANALysis"	Unavailable Seconds
"PUASeconds:SPDH:BIT:ANALysis"	% Unavailable Seconds
"DMINutes:SPDH:BIT:ANALysis"	Degraded Minutes
"PDMinutes:SPDH:BIT:ANALysis"	% Degraded Minutes
"ESEconds:SPDH:CODE:ANALysis"	Code-errored seconds

Structured PDH 140 Mb/s G.826 Analysis Results

:SENSe:DATA? <"result">

Result = "ESEconds:SPDH:M140:TRANsmit:ANALysis:G826"	TX Errored Seconds
"SESeconds:SPDH:M140:TRANsmit:ANALysis:G826"	TX Severely Errored Seconds

PDH Command Reference

SENSe subsystem - Result Returning Commands

"UASeconds:SPDH:M140:TRANsmit:ANALysis:G826"	TX Unavailable Seconds
"PUASeconds:SPDH:M140:TRANsmit:ANALysis:G826"	TX Path Unavailable Seconds
"ESRatio:SPDH:M140:TRANsmit:ANALysis:G826"	TX Errored Second Ratio
"SESRatio:SPDH:M140:TRANsmit:ANALysis:G826"	TX Severely Errored Second Ratio
"ESEConds:SPDH:M140:RECeive:ANALysis:G826"	RX Errored Seconds
"SESeconds:SPDH:M140:RECeive:ANALysis:G826"	RX Severely Errored Seconds
"UASeconds:SPDH:M140:RECeive:ANALysis:G826"	RX Unavailable Seconds
"PUASeconds:SPDH:M140:RECeive:ANALysis:G826"	RX Path Unavailable Seconds
"ESRatio:SPDH:M140:RECeive:ANALysis:G826"	RX Errored Second Ratio
"SESRatio:SPDH:M140:RECeive:ANALysis:G826"	RX Severely Errored Second Ratio

Structured PDH 34 Mb/s G.826 Analysis Results

:SENSe:DATA? <"result">

Result = "ESEConds:SPDH:M34:TRANsmit:ANALysis:G826"	TX Errored Seconds
"SESeconds:SPDH:M34:TRANsmit:ANALysis:G826"	TX Severely Errored Seconds
"UASeconds:SPDH:M34:TRANsmit:ANALysis:G826"	TX Unavailable Seconds
"PUASeconds:SPDH:M34:TRANsmit:ANALysis:G826"	TX Path Unavailable Seconds
"ESRatio:SPDH:M34:TRANsmit:ANALysis:G826"	TX Errored Second Ratio

PDH Command Reference

SENSe subsystem - Result Returning Commands

"SESRatio:SPDH:M34:TRANsmit:ANALysis:G826"	TX Severely Errored Second Ratio
"ESEConds:SPDH:M34:RECeive:ANALysis:G826"	RX Errored Seconds
"SESECONDS:SPDH:M34:RECeive:ANALysis:G826"	RX Severely Errored Seconds
"UASeconds:SPDH:M34:RECeive:ANALysis:G826"	RX Unavailable Seconds
"PUASeconds:SPDH:M34:RECeive:ANALysis:G826"	RX Path Unavailable Seconds
"ESRatio:SPDH:M34:RECeive:ANALysis:G826"	RX Errored Second Ratio
"SESRatio:SPDH:M34:RECeive:ANALysis:G826"	RX Severely Errored Second Ratio

Structured PDH 8 Mb/s G.826 Analysis Results

:SENSe:DATA? <"result">

Result = "ESEConds:SPDH:M8:TRANsmit:ANALysis:G826"	TX Errored Seconds
"SESECONDS:SPDH:M8:TRANsmit:ANALysis:G826"	TX Severely Errored Seconds
"UASeconds:SPDH:M8:TRANsmit:ANALysis:G826"	TX Unavailable Second Counts
"PUASeconds:SPDH:M8:TRANsmit:ANALysis:G826"	TX Path Unavailable Seconds
"ESRatio:SPDH:M8:TRANsmit:ANALysis:G826"	TX Errored Second Ratio
"SESRatio:SPDH:M8:TRANsmit:ANALysis:G826"	TX Severely Errored Second Ratio
"ESEConds:SPDH:M8:RECeive:ANALysis:G826"	RX Errored Seconds
"SESECONDS:SPDH:M8:RECeive:ANALysis:G826"	RX Severely Errored Seconds

SENSe subsystem - Result Returning Commands

"UASeconds:SPDH:M8:RECeive:ANALysis:G826"	RX Unavailable Seconds
"PUASeconds:SPDH:M8:RECeive:ANALysis:G826"	RX Path Unavailable Seconds
"ESRatio:SPDH:M8:RECeive:ANALysis:G826"	RX Errored Second Ratio
"SESRatio:SPDH:M8:RECeive:ANALysis:G826"	RX Severely Errored Second Ratio

Structured PDH 2 Mb/s G.826 Analysis Results

:SENSe:DATA? <"result">

Result = "EBCount:SPDH:M2:TRANsmit:ANALysis:G826"	TX Errored Block Count
"ESECONDS:SPDH:M2:TRANsmit:ANALysis:G826"	TX Errored Seconds
"SESeconds:SPDH:M2:TRANsmit:ANALysis:G826"	TX Severely Errored Seconds
"UASeconds:SPDH:M2:TRANsmit:ANALysis:G826"	TX Unavailable Seconds
"PUASeconds:SPDH:M2:TRANsmit:ANALysis:G826"	TX Path Unavailable Seconds
"BBECount:SPDH:M2:TRANsmit:ANALysis:G826"	TX Background Block Error Count
"ESRatio:SPDH:M2:TRANsmit:ANALysis:G826"	TX Errored Second Ratio
"SESRatio:SPDH:M2:TRANsmit:ANALysis:G826"	TX Severely Errored Second Ratio
"BBERatio:SPDH:M2:TRANsmit:ANALysis:G826"	TX Background Block Error Ratio
"EBCount:SPDH:M2:RECeive:ANALysis:G826"	RX Errored Block Count
"ESECONDS:SPDH:M2:RECeive:ANALysis:G826"	RX Errored Seconds
"SESeconds:SPDH:M2:RECeive:ANALysis:G826"	RX Severely Errored Seconds
"UASeconds:SPDH:M2:RECeive:ANALysis:G826"	RX Unavailable Seconds
"PUASeconds:SPDH:M2:RECeive:ANALysis:G826"	RX Path Unavailable Seconds
"BBECount:SPDH:M2:RECeive:ANALysis:G826"	RX Background Block Error Count

SENSe subsystem - Result Returning Commands

"ESRatio:SPDH:M2:RECeive:ANALysis:G826"	RX Errored Second Ratio
"SESRatio:SPDH:M2:RECeive:ANALysis:G826"	RX Severely Errored Second Ratio
"BBERatio:SPDH:M2:RECeive:ANALysis:G826"	RX Background Block Error Ratio

Structured PDH DS1 G.826 Analysis Results

:SENSe:DATA? <"result">

Result = "ESECONDS:SPDH:DS1:TRANsmit:ANALysis:G826"	TX Errored Seconds
"SESeconds:SPDH:DS1:TRANsmit:ANALysis:G826"	TX Severely Errored Seconds
"UASeconds:SPDH:DS1:TRANsmit:ANALysis:G826"	TX Unavailable Seconds
"PUASeconds:SPDH:DS1:TRANsmit:ANALysis:G826"	TX Path Unavailable Seconds
"ESRatio:SPDH:DS1:TRANsmit:ANALysis:G826"	TX Errored Second Ratio
"SESRatio:SPDH:DS1:TRANsmit:ANALysis:G826"	TX Severely Errored Second Ratio
"EBCOUNT:SPDH:DS1:RECeive:ANALysis:G826"	RX Errored Block Count
"ESECONDS:SPDH:DS1:RECeive:ANALysis:G826"	RX Errored Seconds
"SESeconds:SPDH:DS1:RECeive:ANALysis:G826"	RX Severely Errored Seconds
"UASeconds:SPDH:DS1:RECeive:ANALysis:G826"	RX Unavailable Seconds
"PUASeconds:SPDH:DS1:RECeive:ANALysis:G826"	RX Path Unavailable Seconds
"BBECOUNT:SPDH:DS1:RECeive:ANALysis:G826"	RX Background Block Error Count
"ESRatio:SPDH:DS1:RECeive:ANALysis:G826"	RX Errored Second Ratio

SENSe subsystem - Result Returning Commands

"SESRatio:SPDH:DS1:RECeive:ANALysis:G826"	RX Severely Errored Second Ratio
"BBERatio:SPDH:DS1:RECeive:ANALysis:G826"	RX Background Block Error Ratio

Structured PDH DS3 G.826 Analysis Results

:SENSe:DATA? <"result">

Result = "EBCount:SPDH:DS3:TRANsmit:ANALysis:G826"	TX Errored Block Count
"ESEConds:SPDH:DS3:TRANsmit:ANALysis:G826"	TX Errored Seconds
"SESeconds:SPDH:DS3:TRANsmit:ANALysis:G826"	TX Severely Errored Seconds
"UASeconds:SPDH:DS3:TRANsmit:ANALysis:G826"	TX Unavailable Seconds
"PUASeconds:SPDH:DS3:TRANsmit:ANALysis:G826"	TX Path Unavailable Seconds
"BBECount:SPDH:DS3:TRANsmit:ANALysis:G826"	TX Background Block Error Count
"ESRatio:SPDH:DS3:TRANsmit:ANALysis:G826"	TX Errored Second Ratio
"SESRatio:SPDH:DS3:TRANsmit:ANALysis:G826"	TX Severely Errored Second Ratio
"BBERatio:SPDH:DS3:TRANsmit:ANALysis:G826"	TX Background Block Error Ratio
"EBCount:SPDH:DS3:RECeive:ANALysis:G826"	RX Errored Block Count
"ESEConds:SPDH:DS3:RECeive:ANALysis:G826"	RX Errored Seconds
"SESeconds:SPDH:DS3:RECeive:ANALysis:G826"	RX Severely Errored Seconds
"UASeconds:SPDH:DS3:RECeive:ANALysis:G826"	RX Unavailable Seconds
"PUASeconds:SPDH:DS3:RECeive:ANALysis:G826"	RX Path Unavailable Seconds
"BBECount:SPDH:DS3:RECeive:ANALysis:G826"	RX Background Block Error Count

SENSe subsystem - Result Returning Commands

"ESRatio:SPDH:DS3:RECeive:ANALysis:G826"	RX Errored Second Ratio
"SESRatio:SPDH:DS3:RECeive:ANALysis:G826"	RX Severely Errored Second Ratio
"BBERatio:SPDH:DS3:RECeive:ANALysis:G826"	RX Background Block Error Ratio

Structured PDH BIT G.826 Analysis Results

:SENSe:DATA? <"result">

Result =	"EBCount:SPDH:BIT:RECeive:ANALysis:G826"	RX Errored Block Count
	"ESEConds:SPDH:BIT:RECeive:ANALysis:G826"	RX Errored Seconds
	"SESeconds:SPDH:BIT:RECeive:ANALysis:G826"	RX Severely Errored Seconds
	"UASeconds:SPDH:BIT:RECeive:ANALysis:G826"	RX Unavailable Seconds
	"BBECount:SPDH:BIT:RECeive:ANALysis:G826"	RX Background Block Error Count
	"ESRatio:SPDH:BIT:RECeive:ANALysis:G826"	RX Errored Second Ratio
	"SESRatio:SPDH:BIT:RECeive:ANALysis:G826"	RX Severely Errored Second Ratio
	"BBERatio:SPDH:BIT:RECeive:ANALysis:G826"	RX Background Block Error Ratio

Structured PDH M.2100 Analysis Results

:SENSe:DATA? <"result">

Result =	"ESEConds:SPDH:M140:TRANsmit:ANALysis:M2100"	TX error seconds
	"ESEConds:SPDH:M140:RECeive:ANALysis:M2100"	RX error seconds
	"SESeconds:SPDH:M140:TRANsmit:ANALysis:M2100"	TX severely errored seconds
	"SESeconds:SPDH:M140:RECeive:ANALysis:M2100"	RX severely errored seconds

SENSe subsystem - Result Returning Commands

"UASeconds:SPDH:M140:TRANsmit:ANALysis:M2100"	TX unavailable seconds
"UASeconds:SPDH:M140:RECeive:ANALysis:M2100"	RX unavailable seconds
"ESEConds:SPDH:M34:TRANsmit:ANALysis:M2100"	TX error seconds
"ESEConds:SPDH:M34:RECeive:ANALysis:M2100"	RX error seconds
"SESeconds:SPDH:M34:TRANsmit:ANALysis:M2100"	TX severely errored seconds
"SESeconds:SPDH:M34:RECeive:ANALysis:M2100"	RX severely errored seconds
"UASeconds:SPDH:M34:TRANsmit:ANALysis:M2100"	TX unavailable seconds
"UASeconds:SPDH:M34:RECeive:ANALysis:M2100"	RX unavailable seconds
"ESEConds:SPDH:M8:TRANsmit:ANALysis:M2100"	TX error seconds
"ESEConds:SPDH:M8:RECeive:ANALysis:M2100"	RX error seconds
"SESeconds:SPDH:M8:TRANsmit:ANALysis:M2100"	TX severely errored seconds
"SESeconds:SPDH:M8:RECeive:ANALysis:M2100"	RX severely errored seconds
"UASeconds:SPDH:M8:TRANsmit:ANALysis:M2100"	TX unavailable seconds
"UASeconds:SPDH:M8:RECeive:ANALysis:M2100"	RX unavailable seconds
"ESEConds:SPDH:M2:TRANsmit:ANALysis:M2100"	TX error seconds
"ESEConds:SPDH:M2:RECeive:ANALysis:M2100"	RX error seconds
"SESeconds:SPDH:M2:TRANsmit:ANALysis:M2100"	TX severely errored seconds
"SESeconds:SPDH:M2:RECeive:ANALysis:M2100"	RX severely errored seconds
"UASeconds:SPDH:M2:TRANsmit:ANALysis:M2100"	TX unavailable seconds

SENSe subsystem - Result Returning Commands

"UASeconds:SPDH:M2:RECeive:ANALysis:M2100"	RX unavailable seconds
"ESEConds:SPDH:DS1:TRANsmit:ANALysis:M2100"	TX error seconds
"ESEConds:SPDH:DS1:RECeive:ANALysis:M2100"	RX error seconds
"SESeconds:SPDH:DS1:TRANsmit:ANALysis:M2100"	TX severely errored seconds
"SESeconds:SPDH:DS1:RECeive:ANALysis:M2100"	RX severely errored seconds
"UASeconds:SPDH:DS1:TRANsmit:ANALysis:M2100"	TX unavailable seconds
"UASeconds:SPDH:DS1:RECeive:ANALysis:M2100"	RX unavailable seconds
"ESEConds:SPDH:DS3:TRANsmit:ANALysis:M2100"	TX error seconds
"ESEConds:SPDH:DS3:RECeive:ANALysis:M2100"	RX error seconds
"SESeconds:SPDH:DS3:TRANsmit:ANALysis:M2100"	TX severely errored seconds
"SESeconds:SPDH:DS3:RECeive:ANALysis:M2100"	RX severely errored seconds
"UASeconds:SPDH:DS3:TRANsmit:ANALysis:M2100"	TX unavailable seconds
"UASeconds:SPDH:DS3:RECeive:ANALysis:M2100"	RX unavailable seconds

Structured PDH M.2110 Analysis Results

:SENSe:DATA? <"result">

Result = "MIN15:SPDH:ANALysis:M2110"	M.2110 15 minute BIS Result
"HOUR1:SPDH:ANALysis:M2110"	M.2110 1 hour BIS Result
"HOUR2:SPDH:ANALysis:M2110"	M.2110 2 hour BIS Result
"HOUR24:SPDH:ANALysis:M2110"	M.2110 24 hour BIS Result
"DAY7:SPDH:ANALysis:M2110"	M.2110 7 day BIS Result

SENSe subsystem - Result Returning Commands

Structured PDH M.2120 ANALysis Results

:SENSe:DATA? <"result">

Result =	TR1:SPDH:TRANsmit:ANALysis:M2120	15 minute TX threshold report
	TR2:SPDH:TRANsmit:ANALysis:M2120	24 hour TX threshold report
	TR1:SPDH:RECeive:ANALysis:M2120	15 minute RX threshold report
	TR2:SPDH:RECeive:ANALysis:M2120	24 hour RX threshold report

Structured PDH 2 Mb/S FAS Error Analysis Results

:SENSe:DATA? <"result">

Result =	"ECount:SPDH:M2:FAS"	Error count
	"ESECONDS:SPDH:M2:FAS:ANALYSIS"	Error Seconds
	"PESECONDS:SPDH:M2:FAS:ANALYSIS"	% Error Seconds
	"EFSECONDS:SPDH:M2:FAS:ANALYSIS"	Error Free Seconds
	"PEFSECONDS:SPDH:M2:FAS:ANALYSIS"	% Error Free Seconds
	"SESECONDS:SPDH:M2:FAS:ANALYSIS"	Severely Errored Seconds
	"PSESECONDS:SPDH:M2:FAS:ANALYSIS"	% Severely Errored Seconds
	"UASECONDS:SPDH:M2:FAS:ANALYSIS"	Unavailable Seconds
	"PUASECONDS:SPDH:M2:FAS:ANALYSIS"	% Unavailable Seconds
	"DMINUTES:SPDH:M2:FAS:ANALYSIS"	Degraded Minutes
	"PDMINUTES:SPDH:M2:FAS:ANALYSIS"	% Degraded Minutes
	"ESECONDS:SPDH:CODE:ANALYSIS"	Code errored seconds

SENSe subsystem - Result Returning Commands

Structured PDH 8 Mb/S FAS Error Analysis Results

:SENSe:DATA? <"result">

Result =	"ECOut:SPDH:M8:FAS"	Error count
	"ESECONDS:SPDH:M8:FAS:ANALYSIS"	Error Seconds
	"PESECONDS:SPDH:M8:FAS:ANALYSIS"	% Error Seconds
	"EFSECONDS:SPDH:M8:FAS:ANALYSIS"	Error Free Seconds
	"PEFSECONDS:SPDH:M8:FAS:ANALYSIS"	% Error Free Seconds
	"SESECONDS:SPDH:M8:FAS:ANALYSIS"	Severely Errored Seconds
	"PSESECONDS:SPDH:M8:FAS:ANALYSIS"	% Severely Errored Seconds
	"UASECONDS:SPDH:M8:FAS:ANALYSIS"	Unavailable Seconds
	"PUASECONDS:SPDH:M8:FAS:ANALYSIS"	% Unavailable Seconds
	"DMINUTES:SPDH:M8:FAS:ANALYSIS"	Degraded Minutes
	"PDMINUTES:SPDH:M8:FAS:ANALYSIS"	% Degraded Minutes
	"ESECONDS:SPDH:CODE:ANALYSIS"	Code errored seconds

Structured PDH 34 Mb/S FAS Error Analysis Results

:SENSe:DATA? <"result">

Result =	"ECOut:SPDH:M34:FAS"	Error count
	"ESECONDS:SPDH:M34:FAS:ANALYSIS"	Error Seconds
	"PESECONDS:SPDH:M34:FAS:ANALYSIS"	% Error Seconds
	"EFSECONDS:SPDH:M34:FAS:ANALYSIS"	Error Free Seconds
	"PEFSECONDS:SPDH:M34:FAS:ANALYSIS"	% Error Free Seconds
	"SESECONDS:SPDH:M34:FAS:ANALYSIS"	Severely Errored Seconds
	"PSESECONDS:SPDH:M34:FAS:ANALYSIS"	% Severely Errored Seconds
	"UASECONDS:SPDH:M34:FAS:ANALYSIS"	Unavailable Seconds
	"PUASECONDS:SPDH:M34:FAS:ANALYSIS"	% Unavailable Seconds

SENSe subsystem - Result Returning Commands

"DMINutes:SPDH:M34:FAS:ANALysis"	Degraded Minutes
"PDMinutes:SPDH:M34:FAS:ANALysis"	% Degraded Minutes
"ESEConds:SPDH:CODE:ANALysis"	Code errored seconds

Structured PDH 140 Mb/S FAS Error Analysis Results

:SENSe:DATA? <"result">

Result =	"ECOunt:SPDH:M140:FAS"	Error count
	"ESEConds:SPDH:M140:FAS:ANALysis"	Error Seconds
	"PESeconds:SPDH:M140:FAS:ANALysis"	% Error Seconds
	"EFSeconds:SPDH:M140:FAS:ANALysis"	Error Free Seconds
	"PEFSeconds:SPDH:M140:FAS:ANALysis"	% Error Free Seconds
	"SESeconds:SPDH:M140:FAS:ANALysis"	Severely Errored Seconds
	"PSESeconds:SPDH:M140:FAS:ANALysis"	% Severely Errored Seconds
	"UASeconds:SPDH:M140:FAS:ANALysis"	Unavailable Seconds
	"PUASeconds:SPDH:M140:FAS:ANALysis"	% Unavailable Seconds
	"DMINutes:SPDH:M140:FAS:ANALysis"	Degraded Minutes
	"PDMinutes:SPDH:M140:FAS:ANALysis"	% Degraded Minutes
	"ESEConds:SPDH:CODE:ANALysis"	Code errored seconds

Structured PDH CRC Error Analysis Results

:SENSe:DATA? <"result">

Result =	"ECOunt:PDH:CRC"	Error Count
	"ESEConds:SPDH:CRC:ANALysis"	Error Seconds
	"PESeconds:SPDH:CRC:ANALysis"	% Error Seconds
	"EFSeconds:SPDH:CRC:ANALysis"	Error Free Seconds
	"PEFSeconds:SPDH:CRC:ANALysis"	% Error Free Seconds

SENSe subsystem - Result Returning Commands

"SESeconds:SPDH:CRC:ANALysis"	Severely Errored Seconds
"PSESeconds:SPDH:CRC:ANALysis"	% Severely Errored Seconds
"UASeconds:SPDH:CRC:ANALysis"	Unavailable Seconds
"PUASeconds:SPDH:CRC:ANALysis"	% Unavailable Seconds
"DMINutes:SPDH:CRC:ANALysis"	Degraded Minutes
"PDMINutes:SPDH:CRC:ANALysis"	% Degraded Minutes
"ESEConds:SPDH:CODE:ANALysis"	Code errored seconds

Option UKZ CRC-4 at 2Mb/s CRC-6 at DS1

Structured PDH REBE Error Analysis Results

:SENSe:DATA? <"result">

Result =	"ECount:SPDH:REBE"	Error Count
	"ESEConds:SPDH:REBE:ANALysis"	Error Seconds
	"PESeconds:SPDH:REBE:ANALysis"	% Error Seconds
	"EFSeconds:SPDH:REBE:ANALysis"	Error Free Seconds
	"PEFSeconds:SPDH:REBE:ANALysis"	% Error Free Seconds
	"SESeconds:SPDH:REBE:ANALysis"	Severely Errored Seconds
	"PSESeconds:SPDH:REBE:ANALysis"	% Severely Errored Seconds
	"UASeconds:SPDH:REBE:ANALysis"	Unavailable Seconds
	"PUASeconds:SPDH:REBE:ANALysis"	% Unavailable Seconds
	"DMINutes:SPDH:REBE:ANALysis"	Degraded Minutes
	"PDMINutes:SPDH:REBE:ANALysis"	% Degraded Minutes
	"ESEConds:SPDH:CODE:ANALysis"	Code errored seconds

SENSe subsystem - Result Returning Commands

Structured PDH Alarm Seconds Results

:SENSe:DATA? <"result">

Result =	"ASEConds:PLOSs"	Power loss
	"ASEConds:SPDH:LOS"	Loss Of Signal
	"ASEConds:SPDH:M2:LOF"	2 Mb/s Frame Loss
	"ASEConds:SPDH:M8:LOF"	8 Mb/s Frame Loss
	"ASEConds:SPDH:M34:LOF"	34 Mb/s Frame Loss
	"ASEConds:SPDH:M140:LOF"	140 Mb/s Frame Loss
	"ASEConds:SPDH:DS1:OOF"	DS1 Out Of Frame
	"ASEConds:SPDH:DS3:OOF"	DS3 Out Of Frame
	"ASEConds:SPDH:OOF"	DS1/DS3 Out of Frame
	"ASEConds:SPDH:DS3:EXZ"	DS3 Excess zeros
	"ASEConds:SPDH:DS1:EXZ"	DS1 Excess zeros
	"ASEConds:SPDH:DS3:IDLE"	DS3 Idle
	"ASEConds:SPDH:DS3:FMM"	DS3 Frame Mismatch
	"ASEConds:SPDH:FERF"	FERF (aka RAI)
	"ASEConds:SPDH:AIS"	AIS
	"ASEConds:SPDH:MFM"	Multiframe Loss
	"ASEConds:SPDH:RAI"	Remote Alarm
	"ASEConds:SPDH:RMFR"	Remote Multiframe Alarm
	"ASEConds:SPDH:PSL"	Pattern Sync Loss

Structured PDH Round Trip Delay Results

:SENSe:DATA? <"result">

Result =	"RTDelay:SPDH:COUNT"	Round Trip Delay
----------	----------------------	------------------

FETCh subsystem

FETCh subsystem

The FETCh subsystem is used to retrieve data directly accumulated by the instrument.

:FETCh:SCALAr:DATA:TELEcom:PDH:SPARe?

Returns : <string>

Returns spare bit result as a string.

:FETCh:SCALAr:DATA:TELEcom:PDH:NFASe?

Returns : <string>

Returns NFAS word as a string.

:FETCh:SCALAr:DATA:TELEcom:PDH:CAS?

Returns : <string>

Returns CAS word as a string.

:FETCh:STRing:DATA:TELEcom:SPDH:FEAC?

Returns: <numeric>

Returns the currently detected FEAC code as a 6 bit binary string.

:FETCh:STRing:DATA:TELEcom:SPDH:FEAC:TEXT?

Returns: <string>

PDH Command Reference

FETCh subsystem

Returns the currently detected FEAC code decoded as the message types defined in ANSI T1.107-1995. Note that two additional codes which are undefined by the ANSI spec have been decoded as follows:

Code	Message
00010010 11111111	NIU Loop Up
00100100 11111111	NIU Loop Down

:FETCh:STRing:DATA:TELEcom:SPDH:FEAC:LAST?

Returns: <numeric>

Returns the last detected non-idle FEAC code as a 6 bit binary string.

:FETCh:STRing:DATA:TELEcom:SPDH:FEAC:LAST:TEXT?

Returns: <string>

Returns the last detected non-idle FEAC code decoded as the message types defined in ANSI T1.107-1995. Note that two additional codes which are undefined by the ANSI spec have been decoded as follows

Code	Message
00010010 11111111	NIU Loop Up
00100100 11111111	NIU Loop Down

:FETCh:SCALar:DATA:TELEcom:SPDH:TSLot:SIGNaling? <numeric>

<numeric> = 1 - 31 Timeslot number
1 to 24 Timeslot Number (DS1 Signalling Bits) (Option 110 only)

Returns: <string>

Returns the signalling bits for the specified timeslot as a string.

FETCh subsystem

:FETCh:ARRay:DATA:TELEcom:SPDH:ASCan:M140?

Returns : <numeric>

Retained for backwards compatibility. Returns a number indicating the status of the 140 Mb/s Alarm Scan. For new developments the command :FETCh:ARRay:DATA:TELEcom:SPDH:ASCan? is recommended.

:FETCh:ARRay:DATA:TELEcom:SPDH:ASCan:M34?

Returns : <numeric>,<numeric>,<numeric>,<numeric>

Retained for backwards compatibility. Returns 4 numbers, separated by commas, indicating the status of the 34 Mb/s Alarm Scan. For new developments the command :FETCh:ARRay:DATA:TELEcom:SPDH:ASCan? is recommended.

:FETCh:ARRay:DATA:TELEcom:SPDH:ASCan:M8?

Returns (each of <numeric>,<numeric>,<numeric>,<numeric>
rows 1 to 4):

Retained for backwards compatibility. Returns 4 rows of 4 numbers, separated by commas, indicating the status of the 8 Mb/s Alarm Scan. For new developments the command :FETCh:ARRay:DATA:TELEcom:SPDH:ASCan? is recommended.

:FETCh:ARRay:DATA:TELEcom:SPDH:ASCan:M2?

Returns (each of <numeric>,<numeric>,<numeric>,<numeric>
rows 1 to 16):

Retained for backwards compatibility. Returns 16 rows of 4 numbers separated by commas, indicating the status of the 2 Mb/s Alarm Scan. For new developments the command :FETCh:ARRay:DATA:TELEcom:SPDH:ASCan? is recommended.

:FETCh:ARRay:DATA:TELEcom:SPDH:ASCan?

Returns (each of one or <numeric>{,<numeric>}
more rows):

PDH Command Reference

FETCh subsystem

The results returned are those for the last FULL scan. Results from partial scans are not available. If no full scan has been completed since the instrument was powered up, this command will return -1.

If data is available it is returned as a set of string arrays. The arrays are separated by a CR/LF pair. The arrays consist of comma separated numerics, one for each scanned tributary. The numeric is a boolean flag which is used as follows.

Value	State
0	No Problems detected
1	Alarms Detected

For specific signal structures, the format of the returned strings are shown below:

1) 140Mb/s Interface Rate, Structured, 2Mb/s Test Signal

Each level of the structure scanned returns its results in one array apart from the fourth level, in this case 2Mb/s, where its results are split into 4 arrays.

140Mb/s	0
34Mb/s	0,0,1,0
8Mb/s	0,1,0,1,1,0,0,1,1,1,1,0,0,0,0,0
2Mb/s	1,1,1,0,0,1,0,0,0,0,0,1,1,1,1,0 0,1,1,1,1,1,0,0,0,0,0,0,0,0,0,0 1,1,1,1,0,0,1,0,0,0,1,1,1,1,0,0 0,0,0,0,0,0,0,0,0,0,0,0,0,0,0,0

2) STM-1 Interface Rate, DS3 Payload, Structured, Nx64kb/s Test Signal

When there are less than four levels in the structure, each levels results are returned in one array.

DS3	0
DS2	0,0,1,0,1,1,1
DS1	0,1,0,1,1,0,0,1,1,1,1,0,0,0,0,0,1,0,1,1,1,0,0,0,0,0,1,1

SDH SCPI Command Reference

OUTPut subsystem, see page 4- 4.

SOURce subsystem - Transmitter SDH Settings Commands, see page 4- 7.

SDH Mapping Settings, see page 4- 11.

SOURce subsystem - Transmitter SDH OVERHEAD SETUP, see page 4- 23.

SOURce subsystem - Transmitter SDH Test Function Commands, see page 4-36.

INPut subsystem, see page 4- 63.

SENSe subsystem - Receiver SDH Settings, see page 4- 67.

SENSe subsystem - Receiver SDH Test Function Commands, see page 4-76.

SENSe subsystem - Alarm Scan Control, see page 4-83.

SENSe subsystem - SDH Tributary Scan Control, see page 4- 85.

SENSe subsystem -Optical Power Measurement Settings, see page 4- 87.

SENSe subsystem - Result Returning Commands, see page 4- 88.

FETCh subsystem, see page 4- 99.

SDH Command Reference

SDH Command Reference

SDH Command Reference

This chapter contains detailed information on the SCPI (Standard Commands for Programming Instruments) and IEEE 488.2 common commands you will use when writing programs to control your HP 37717C for SDH operation.

Please also refer to chapter 2 Common Commands for general information on SCPI command formats and for a list of commands that are common to PDH, SDH, SONET, ATM or Jitter operation; they are as follows:

SCPI Command Format

Remote Control Commands

Instrument Options

INSTRument subsystem

SOURce subsystem

SOURce subsystem - Transmitter Common Commands

INPut subsystem

SENSe subsystem

SENSe subsystem - Receiver Common Commands

SENSe subsystem - Test Timing

SENSe subsystem - Analysis Control

SENSe subsystem - Trouble Scan Results

SENSe subsystem - Configuring Graphics

SENSe subsystem - Managing Graphics Stores

SENSe subsystem - Retrieving Graphics Store Data

SENSe subsystem - Retrieving Data for a Single Graph

SENSe subsystem - Obtaining Graphics End of Measurement Results

STATus Subsystem

SYSTem Subsystem

IEEE common capabilities

OUTPut subsystem**OUTPut subsystem**

This subsystem controls the characteristics of the instrument's output ports.

:OUTPut:TELEcom:SDH:RATE <discrete>

<discrete> =	STM0	STM-0 Electrical
	STM1	STM-1 Electrical

Is only valid when :SOURce:DATA:TELEcom:SOURce <discrete> is set to <SDH>.

:OUTPut:TELEcom:SDH:RATE?

Returns: <discrete>

:OUTPut:TELEcom:SDH:LEVel <discrete>

<discrete> =	XCON	450 feet simulated cable
	HIGH	0 feet simulated cable
	LOW	900 feet simulated cable

Selects the signal level for the STM-0 output.

The corresponding query returns the STM-0 signal level in discrete short form.

:OUTPut:TELEcom:SDH:LEVel?

Returns: <discrete>

:OUTPut:TELEcom:OPT1:RATE?

Returns: <rate>

Always returns STM1. Is only valid when Option UH1, STM-1 Optical Interface, is fitted and :SOURce:DATA:TELEcom:SOURce <discrete> is set to OPT1.

:OUTPut:TELEcom:OPT4:RATE <discrete>

<discrete> =	STM0	STM-0 optical
--------------	------	---------------

SDH Command Reference

OUTPut subsystem

STM1 STM-1 Optical

STM4 STM-4 Optical

Selects the output rate for the STM-0/STM-1/STM-4 optical output port. This command is only valid when :SOURce:DATA:TELEcom:SOURce <discrete> is set to OPT4.

The corresponding query returns the STM-0/STM-1/STM-4 output rate in discrete form as listed above. If the OPT4 port is not selected, STM4 will be returned as the default.

:OUTPut:TELEcom:OPT4:RATE?

Returns : <discrete>

:OUTPut:TELEcom:OPT4:INTerface <discrete>

<discrete> =	OPTical	Optical output
	BINary	Binary output

Selects the output interface on the Optical module and is only applicable if option 0YH is present.

The corresponding query returns the selected interface in discrete form, as listed above.

:OUTPut:TELEcom:OPT4:INTerface?

Returns: <discrete>

:OUTPut:TELEcom:OPT4:INTerface:BINary:CLOCK:POLarity <discrete>

<discrete> =	INVerted	Clock inverted
	NORMAl	Clock not inverted

Selects the polarity of the binary clock output on the Optical module and is only applicable if option 0YH is present.

The corresponding query returns the polarity of the binary clock output in discrete form, as listed above.

OUTPut subsystem

:OUTPut:TELEcom:OPT4:INTerface:BINary:CLOCK:POLarity?

Returns : <discrete>

:OUTPut:TELEcom:OPT4:INTerface:BINary:DATA:POLarity <discrete>

<discrete> =	INVerted	Data inverted
	NORMal	Data not inverted

Selects the polarity of the binary data output of the Optical module and is only applicable if option 0YH is present.

The corresponding query returns the polarity of the binary data output in discrete form, as listed above.

:OUTPut:TELEcom:OPT4:INTerface:BINary:DATA:POLarity?

Returns : <discrete>

:OUTPut:TELEcom:OPT4:WAVelength <discrete>

<discrete> =	NM1310	1310 nm
	NM1550	1550 nm

Selects the wavelength of the output optical signal on the Optical module Option 130 only.

The corresponding query returns the output optical wavelength in discrete form, as listed above.

:OUTPut:TELEcom:OPT4:WAVelength?

Returns : <discrete>

SOURce subsystem - Transmitter SDH Settings Commands**SDH Clock settings****:SOURce:CLOCK:SDH:SOURce <discrete>**

<discrete> =	INTernal	Internal
	EXTernal	External Clock/Data
	RSTM0	STM-0 Electrical
	ROPT0	STM-0 Optical
	RMON0	STM-0 Monitor
	RBIN0	STM-0 Binary
	RSTM1	STM-1 Electrical
	ROPT1	STM-1 Optical (Option UH1 only)
	RMON1	STM-1 Monitor
	RBIN1	STM-1 Binary
	ROPT4	STM-4 Optical
	RMON4	STM-4 Monitor
	RBIN4	STM-4 Binary

Selects the SDH transmitter clock sync source. If the RX is set to an SDH rate, then the only received clock rate that may be selected is the one in use. This restriction does not apply if the RX is set to a non SDH rate. If EXT is selected, the Format is set using :SOURce:CLOCK:SDH:FORMat <discrete>.

The corresponding query returns the transmitter SDH clock sync source in discrete form as listed above.

:SOURce:CLOCK:SDH:SOURce?

Returns : <discrete>

:SOURce:CLOCK:SDH:FORMat <discrete>

<discrete> =	CLOCK	Clock Format
	DATA	Data Format

SOURce subsystem - Transmitter SDH Settings Commands

K64	64kb/s data
DS1Bits	DS1 bit rate

Selects the transmitter SDH EXT clock sync source format.

The corresponding query returns the EXT clock sync source format in discrete form as listed above.

:SOURce:CLOCK:SDH:FORMat?

Returns : <discrete>

:SOURce:CLOCK:SDH:FOFFset <boolean>

<boolean> = 0 or OFF
1 or ON

Enables/disables the SDH Frequency Offset. The amount of Offset is set using :SOURce:CLOCK:SDH:FOFFset:OFFSet <numeric>,<suffix>.

The corresponding query returns the SDH Frequency Offset state as 0 or 1.

:SOURce:CLOCK:SDH:FOFFset?

Returns : <boolean> 0 or 1

:SOURce:CLOCK:SDH:FOFFset:OFFSet <numeric>,<suffix>

<numeric> =	-999 to +999	Parts per Million
	-0.000999 to 0.000999	% or Ratio
<suffix> =	PPM	Parts per Million
	PCT	Percentage

Sets the amount of SDH Frequency Offset when Frequency Offset is enabled by setting :SOURce:CLOCK:SDH:FOFFset <boolean> to ON. If Ratio is chosen as the method of specifying Offset, no suffix is required.

The corresponding query returns the amount of SDH Frequency Offset in ppm.

SOURce subsystem - Transmitter SDH Settings Commands

:SOURce:CLOCK:SDH:FOFFset:OFFSet?

Returns : <numeric>

Thru mode settings

:SOURce:DATA:TELEcom:SDH:THRumode <discrete>

<discrete> =	INTernal	Select Normal SDH Mode
	THRU	Select SDH Thru Mode

Selects/Deselects SDH THRU mode.

The corresponding query returns the THRU mode state in discrete form as listed above.

:SOURce:DATA:TELEcom:SDH:THRumode?

Returns : <discrete>

:SOURce:DATA:TELEcom:SDH:THRumode:POVerwrite <payload>

<discrete> =	OFF	Payload Overwrite Off
	AU4	Overwrite AU-4 payload
	AU3	Overwrite AU-3 payload
	TU3	Overwrite TU-3 payload
	TU2	Overwrite TU-2 payload
	TU12	Overwrite TU-12 payload
	TU11	Overwrite TU-11 payload

Selects the type of thru-mode payload to overwrite.

Note that the channel number must be selected before entering thru-mode because it is fixed while in thru-mode.

The corresponding query returns the payload overwrite state in discrete form as listed above.

SOURce subsystem - Transmitter SDH Settings Commands

:SOURce:DATA:TELEcom:SDH:THRumode:POVerwrite?

Returns : <discrete>

:SOURce:DATA:TELEcom:SDH:THRumode:COVerwrite <boolean>

<boolean> =	0 or OFF	Overhead Overwrite Off
	1 or ON	Overhead Overwrite On

Enables/disables section overhead overwrite.

The corresponding query returns the section overhead overwrite state in discrete form as listed above.

:SOURce:DATA:TELEcom:SDH:THRumode:COVerwrite?

Returns : <boolean>

SDH Mapping Settings

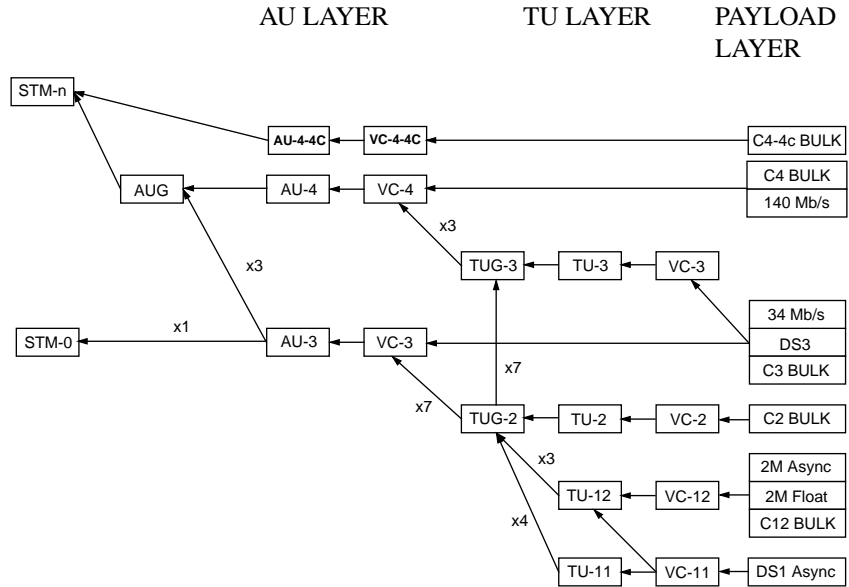

:SOURCE:DATA:TELEcom:SDH:VC4 <numeric>

<numeric> = 1 to 4 VC4 number.

Only valid if :OUTPUT:TELEcom:OPT4:RATE <discrete> is set to a rate higher than STM-1. Selects the transmitted STM-1 VC4 that is selected for test.

The corresponding query returns the STM-1 VC4 selected for test in numeric form, as listed above.

:SOURCE:DATA:TELEcom:SDH:VC4?

Returns : <numeric>

AU Layer Selection

:SOURCE:DATA:TELEcom:SDH:AU:TYPE <discrete>

SOURce subsystem - Transmitter SDH Settings Commands

```

<discrete> =  AU4
                AU3
                AU4_4C

```

Set the AU mapping into an STM-N frame.

The corresponding query returns the AU layer in discrete form as listed above.

:SOURce:DATA:TELEcom:SDH:AU:TYPE?

```

Returns:                <discrete>

```

:SOURce:DATA:TELEcom:SDH:AU3 <numeric>

```

<numeric> =            1 to 3      AU3 Number

```

Selects the SDH Transmitter active AU3 within the AUG.

The corresponding query returns the active AU3 in numeric form.

:SOURce:DATA:TELEcom:SDH:AU3?

```

Returns :                <numeric>

```

TU Layer Selection**:SOURce:DATA:TELEcom:SDH:PAYLoad <discrete>**

```

<discrete> =  VC4 or M140      140 Mb/s
                VC3             STM-0
                TU3 or M34      34 Mb/s
                TU12 or M2      2 Mb/s
                TU2             VC-2
                VC_4C           option 130/131 only
                TU11 or DS1     TU11

```

This command selects the SDH transmitter mapping.

The corresponding query returns the SDH mapping in discrete form, as listed above.

:SOURce:DATA:TELEcom:SDH:PAYLoad?

SOURce subsystem - Transmitter SDH Settings Commands

Returns : <discrete>

Payload Layer Selection

:SOURce:DATA:TELEcom:SDH:MAPPING <discrete>

<discrete> =	M140	140 Mb/s - AU-4 (C-4 only)
	M34	34 Mb/s - VC-3 (C-3 only)
	DS3	DS3 - VC-3 (C-3 only)
	BULK	Bulk Filled (C-4 or C-3)

This command controls the transmitter SDH payload for single payload cases.

Only valid if :SOURce:DATA:TELEcom:SDH:PAYLoad <discrete> is set to VC3 or VC4.

The corresponding query returns the low order mapping in discrete form as listed above.

:SOURce:DATA:TELEcom:SDH:MAPPING?

Returns: <discrete>

:SOURce:DATA:TELEcom:SDH:TRIButary:MAPPING <discrete>

<discrete> =	ASYNc or ASM2	Asynchronous 2 Mb/s
	FBYTe or FLM2	2 Mb/s Floating Byte
	M34 or ASM34	Asynchronous 34 Mb/s
	DS1 or ASDS1	Asynchronous 1.544Mb/s DS1
	DS3 or ASDS3	Asynchronous 44.736 Mb/s DS3
	BULK	Bulk Filled

Selects the transmitter low order mapping. Only valid if

:SOURce:DATA:TELEcom:SDH:PAYLoad <discrete> is set to TU3, TU12 or TU11.

The corresponding query returns the low order mapping in discrete short form.

:SOURce:DATA:TELEcom:SDH:TRIButary:MAPPING?

Returns: <discrete>

SOURce subsystem - Transmitter SDH Settings Commands

TUG Channel

:SOURce:DATA:TELEcom:SDH:TUG3 <numeric>

<numeric> = 1 to 3 TUG3 Number

Selects the SDH Transmitter active TUG3 within the AU4.

The corresponding query returns the active TUG3 in numeric form.

:SOURce:DATA:TELEcom:SDH:TUG3?

Returns : <numeric>

:SOURce:DATA:TELEcom:SDH:TUG2 <numeric>

<numeric> = 1 to 7 TUG2 Number

Selects the SDH Transmitter active TUG2 within the selected TUG3 or AU3.

The corresponding query returns the active TUG2 in numeric form.

:SOURce:DATA:TELEcom:SDH:TUG2?

Returns : <numeric>

:SOURce:DATA:TELEcom:SDH:TRIButary <numeric>

<numeric> = 1 to 3 Tributary Number for TU-12

1 to 4 Tributary number for TU-11

Selects the SDH Transmitter active TU within the selected TUG2.

The corresponding query returns the active tributary in numeric form.

:SOURce:DATA:TELEcom:SDH:TRIButary?

Returns : <numeric>

SOURce subsystem - Transmitter SDH Settings Commands**TU Payload and Test Pattern**

:SOURce:DATA:TELEcom:SDH:PAYLoad:TYPE <discrete>

<discrete> =	UNFRamed	No framing
	FRAMed	8, 34 & 140 Mb/s
	PCM30	2 Mb/s Only
	PCM31	2 Mb/s Only
	PCM30CRC	2 Mb/s Only
	PCM31CRC	2 Mb/s Only
	IM2	2 Mb/s Insert
	IM34	34 Mb/s Insert
	IM140	140 Mb/s Insert
	D4	DS1 Framing Only
	ESF	DS1 Framing Only
	SLC96	DS1 Framing Only
	M13	DS3 Framing Only
	CBIT	DS3 Framing Only
	IDS1	Insert DS1
	IDS3	Insert DS3

Note: This command is not backwards compatible. To set the framing type to be structured use the command **:SOURce:DATA:TELEcom:SDH:PAYLoad:STRucture <discrete>**.

Only valid if a Structured PDH transmitter is fitted.

The corresponding query returns the framing in discrete form as listed above.

:SOURce:DATA:TELEcom:SDH:PAYLoad:TYPE?

Returns : <discrete>

:SOURce:DATA:TELEcom:SDH:PAYLoad:STRucture <discrete>

<discrete> =	UNSTRuctured	All rates
	STRuctured	All framed formats

SOURce subsystem - Transmitter SDH Settings Commands

Selects whether or not the PDH payload signal is to have any further structure or not.

The corresponding query returns the transmitter PDH payload structure setting in discrete form as listed above.

:SOURce:DATA:TELEcom:SDH:PAYLoad:STRucture?

Returns: <discrete>

:SOURce:DATA:TELEcom:SDH:PAYLoad:PATtern <discrete>

<discrete> =	PRBS9	2^9-1
	PRBS11	$2^{11}-1$
	PRBS15	$2^{15}-1$
	PRBS20	$2^{20}-1$
	PRBS23	$2^{23}-1$
	QRSS	$2^{20}-1$ with 14 consecutive zero limit (DS1 only)
	AZERo	All Zeros
	AONE	All Ones
	STRESS	3-in-24 stress pattern (DS1 only) (requires option 110)
	P1010	Word 1010
	P1000	Word 1000
	UWORD	16 Bit User Word

Selects the transmitter SDH payload data pattern.

See :SOURce:DATA:TELEcom:SDH:PAYLoad:TYPE <discrete>
 :SOURce:DATA:TELEcom:SDH:TRIButary:PAYLoad:PATtern <discrete> and
 :SOURce:DATA:TELEcom:SDH:PRIMary:PAYLoad:PATtern <discrete> are
 identical commands. If UWORD is selected, the word pattern is set using
 :SOURce:DATA:TELEcom:SDH:PAYLoad:UWORD <string>.

The corresponding query returns the transmitter SDH payload data pattern in discrete form, as listed above.

SOURce subsystem - Transmitter SDH Settings Commands

:SOURce:DATA:TELEcom:SDH:PAYLoad:PATtern?

Returns : <discrete>

:SOURce:DATA:TELEcom:SDH:PAYLoad:UWORD <string>

Sets the SDH transmitter user word pattern in the range "0000000000000000" to "1111111111111111".

The corresponding query returns the user word pattern as a string.

:SOURce:DATA:TELEcom:SDH:PAYLoad:UWORD?

Returns : <string>

:SOURce:DATA:TELEcom:SDH:PRBS:POLarity <discrete>

<discrete> = INVerted
 NORMal

Selects the PRBS pattern polarity.

The corresponding query returns the polarity in discrete form as listed above.

:SOURce:DATA:TELEcom:SDH:PRBS:POLarity?

Returns: <discrete>

:SOURce:DATA:TELEcom:SDH:PAYLoad:OFFSet <numeric>

<numeric> =	-100 to +100	Parts per Million
	-0.000100 to 0.000100	% or Ratio
<suffix> =	PPM	Parts per Million
	PCT	Percentage

Sets the 140, 34, 2 Mb/s, DS3 or DS1 payload frequency offset in parts per million (ppm).

The corresponding query returns the offset in numeric form.

:SOURce:DATA:TELEcom:SDH:PAYLoad:OFFSet?

SOURce subsystem - Transmitter SDH Settings Commands

Returns: <numeric> ppm

:SOURce:DATA:TELEcom:SDH:TRIButary:CONCatenate <numeric>, <numeric>

<numeric> = (first parameter)	0	Concatenation Off
	2	TU2-2C
	3	TU2-3C
	4	TU2-4C
	5	TU2-5C
	6	TU2-6C
<numeric> = (second parameter)	1 to 6	TU2-2C selected
	1 to 5	TU2-3C selected
	1 to 4	TU2-4C selected
	1 to 3	TU2-5C selected
	1 to 2	TU2-6C selected

Selects the TU2 concatenation (first parameter) and starting at TU (second parameter).

The corresponding query returns the TU2 concatenation and starting at TU in numeric form as listed above.

:SOURce:DATA:TELEcom:SDH:TRIButary:CONCatenate?

Returns : <numeric>, <numeric>

Background Settings

:SOURce:DATA:TELEcom:SDH:AU3:BACKground:PAYLoad:TYPE <numeric>, <discrete>

SOURce subsystem - Transmitter SDH Settings Commands

<numeric>	1 to 3	Background AU3 channel
<discrete> =	TU11	
	TU12	
	UWORD	User word

Selects the mapping type for the selected transmitter background AU3. The user word can be set up using the command

:SOURce:DATA:TELEcom:SDH:AU3:BACKground:PAYLoad:PATtern:UWORD <numeric>, <string>. This is only valid if the AU3 selected is not the active foreground.

The corresponding query returns the selected AU3 mapping type in discrete form as listed above.

:SOURce:DATA:TELEcom:SDH:AU3:BACKground:PAYLoad:TYPE?
<numeric>

<numeric>	1 to 3	Background AU3 channel
Returns:	<discrete>	

:SOURce:DATA:TELEcom:SDH:AU3:BACKground:PAYLoad:PATtern:UWORD <numeric>, <string>

<numeric> =	1 to 3	Background AU3 Channel
<string> =	00000000 to 11111111	User word value in binary

Sets the selected background AU3 user word value. This is only valid if the AU3 selected is not the active foreground.

The corresponding query returns the selected background AU3 user word value in binary string form.

:SOURce:DATA:TELEcom:SDH:AU3:BACKground:PAYLoad:PATtern:UWORD? <numeric>

<numeric>	1 to 3	Background AU3 channel
Returns	<string>	

SOURce subsystem - Transmitter SDH Settings Commands

**:SOURce:DATA:TELEcom:SDH:PRIMary:BACKground:PAYLoad:PATtern
<discrete>**

<discrete> =	PRBS9	2^9-1
	PRBS15	$2^{15}-1$
	NUMBered	(TU2 or framed TU12/TU11)
	P1100	word 1100

Selects the background payload pattern for TUs within the foreground TUG3 or AU3.

The corresponding query returns the background pattern in discrete form as listed above.

**:SOURce:DATA:TELEcom:SDH:PRIMary:BACKground:PAYLoad
:PATtern?**

Returns: <discrete>

:SOURce:DATA:TELEcom:SDH:VC4:BACKground <discrete>

<discrete> =	FIXed	Fixed at 00000000
	AS_FG	As Foreground

Selects the payload in the background (non test) STM-1s. This command only applies if the interface rate is higher than STM-1.

The corresponding query returns the type of payload in the background STM-1s in discrete short form.

:SOURce:DATA:TELEcom:SDH:VC4:BACKground?

Returns: <discrete>

**:SOURce:DATA:TELEcom:SDH:TUG3:BACKground:PAYLoad:PATtern
<numeric> <discrete>**

<numeric> =	1 to 3	TUG 3 to be configured
<discrete>	TU3	TU-3 structure
	TU12	TU-12 structure
	TU11	TU-11 structure
	UWORD	User Defined

SOURce subsystem - Transmitter SDH Settings Commands

Selects the structure in a background TUG3. This command is only valid if the selected TUG3 is not the current foreground.

The corresponding query returns the specified TUG3 background structure in discrete form as listed above.

:SOURce:DATA:TELEcom:SDH:TUG3:BACKground:PAYLoad:PATtern? <numeric>

<numeric> = 1 to 3 TUG 3 Number
Returns: <discrete>

:SOURce:DATA:TELEcom:SDH:TUG3:BACKground:PAYLoad:PATtern:UWORD <numeric> <string>

<numeric> = 1 to 3 TUG 3 to be configured
<string> 8 bit 00000000 to 11111111

Sets the user pattern to be transmitted in the specified background TUG3. This command is only valid if the TUG3 selected is not the current foreground.

The corresponding query returns the background word pattern in the TUG 3 selected by numeric.

:SOURce:DATA:TELEcom:SDH:TUG3:BACKground:PAYLoad:PATtern:UWORD? <numeric>

<numeric> = 1 to 3

Old Commands

The following commands are retained for backwards compatibility:

:SOURce:DATA:TELEcom:SDH:TRIButary:PAYLoad <discrete>

See :SOURce:DATA:TELEcom:SDH:PAYLoad:TYPE <discrete>

:SOURce:DATA:TELEcom:SDH:TRIButary:PAYLoad:PATtern <discrete>

See :SOURce:DATA:TELEcom:SDH:PAYLoad:PATtern <discrete>

:SOURce:DATA:TELEcom:SDH:TRIButary:PAYLoad:UWORD <string>

See :SOURce:DATA:TELEcom:SDH:PAYLoad:UWORD <string>

:SOURce:DATA:TELEcom:SDH:PRIMary:PAYLoad:PATtern <discrete>

See :SOURce:DATA:TELEcom:SDH:PAYLoad:PATtern <discrete>

:SOURce:DATA:TELEcom:SDH:PRIMary:PAYLoad:UWORD <string>

See :SOURce:DATA:TELEcom:SDH:PAYLoad:UWORD <string>

SOURce subsystem - Transmitter SDH OVERHEAD SETUP**SOURce subsystem - Transmitter SDH OVERHEAD SETUP**

Lists the settings for the commands associated with the TRANSMIT OVERHEAD SETUP display.

:SOURce:DATA:TELEcom:SDH:OVERhead:DEFault

Sets all overhead bytes to their default value :

Byte	Value	Byte	Value	Byte	Value	Byte	Value
A1	11110110	A2	00101000	C1/J0	00000001	B1	xxxxxxxx
E1	00000000	F1	00000000	D1	00000000	D2	00000000
D3	00000000	E2	00000000	H1	xxxx10xx	H2	xxxxxxxx
H3	xxxxxxxx	B2	xxxxxxxx	K1	00000000	K2	00000000
D4	00000000	D5	00000000	D6	00000000	D7	00000000
D8	00000000	D9	00000000	D10	00000000	D11	00000000
D12	00000000	S1/Z1	00000000	Z2/M1	00000000	J1	Default
B3	xxxxxxxx	C2	00000001	G1	00000000	F2	00000000
H4	00000000	F3	00000000	K3	00000000	N1	00000000

:SOURce:DATA:TELEcom:SDH:OVERhead:DATA <numeric>, <numeric>, <discrete>, <string>

<numeric> = STM-1 Number: range 1 to 4
(first parameter)

<numeric> = Column Number: range 1 to 3
(second parameter)

<discrete> = A1|A2|C1/J0|Z0|E1|F1|D1|D2|D3|H1|K1|
K2|D4|D5|D6|D7|D8|D9|D10|D11
D12|S1/Z1|Z2/M1|E2|X21|X22|X23|X31
X32|X33|X52|X53|X61|X62|X63
X71|X72|X73|X81|X82|X83|X93

<string> = "00000000" to "11111111"

Sets the binary value for the selected transmitter section overhead byte. The byte number is given by its defined name if it has one. Undefined bytes are represented

SOURce subsystem - Transmitter SDH OVERHEAD SETUP

by "Xrc", where r is the numerical value of the bytes row in the transport overhead and c is the numerical value of the bytes column in the transport overhead.

If an STM-1 signal is being transmitted, the only applicable value of STM-1 number is 1. Notice that column number 1 is actually columns 1,4 & 7, 2 is columns 2,5 & 8 and 3 is columns 3,6 & 9. All other bytes can have their values set by using the Xrc name.

The byte is set to the binary representation of the given 8 character string.

In the case of Columns 1,4,7 only bits 2 and 3 of H1 may be set. The value sent must however still be 8 bits long. The unused bits should be marked 'x', i.e. to set bits 2 and 3 to '11' send the value 'xxxx11xx'.

C1/J0 byte: To set J0 using this command

:SOURce:DATA:TELEcom:SDH:OVERhead:J0:PATtern <discrete> must be set to "FIXed". If any other SDH option is fitted, the C1 capability is available and J0 is not available.

Z0 byte is only available if Option 130 is fitted and STM-4 is selected.

The corresponding query returns the binary value of the byte named within the selected STM-1 column.

:SOURce:DATA:TELEcom:SDH:OVERhead:DATA? <numeric>, <numeric>, <discrete>

Returns : <string>

:SOURce:DATA:TELEcom:SDH:OVERhead:DATA:HEXadecimal <numeric>, <numeric>, <discrete>, <string>

<numeric> = (first parameter)	STM-1 Number: range 1 to 4
<numeric> = (second parameter)	Column Number: range 1 to 3
<discrete> =	A1 A2 J0 Z0 E1 F1 D1 D2 D3 H1 K1 K2 D4 D5 D6 D7 D8 D9 D10 D11 D12 S1 Z1 M1 Z2 E2 X21 X22 X23 X31 X32 X33 X52 X53 X61 X62 X63 X71 X72 X73 X81 X82 X83 X93
<string> =	"00" to "FF"

SOURce subsystem - Transmitter SDH OVERHEAD SETUP

Sets the hexadecimal value for the selected transmitter transport overhead byte. The byte number is given by its defined name if it has one. Undefined bytes are represented by "Xrc", where r is the numerical value of the bytes row in the transport overhead and c is the numerical value of the bytes column in the transport overhead.

If an STM-1 signal is being transmitted, the only applicable value of STM-1 is 1.

Notice that column number 1 is actually columns 1,4 & 7, 2 is columns 2,5 & 8 and 3 is columns 3,6 & 9. All other bytes can have their values set by using the "Xrc" name. The byte is set to the binary representation of the given 8 character string.

In the case of Columns 1,4,7 only bits 2 and 3 of H1 may be set. Any hexadecimal value can be sent but only bits 2 and 3 will be set and all other bits will remain unchanged.

The J0 capability is available at STM-0 and STM-1 only. To set J0 using this command :SOURce:DATA:TELEcom:SDH:OVERhead:J0:PATTern <discrete> must be set to "FIXed".

Z0 byte is only available if Option 130 is fitted and STM-4 is selected.

The corresponding query returns the hexadecimal value of the byte named within the selected STM-1 column.

:SOURce:DATA:TELEcom:SDH:OVERhead:DATA:HEXadecimal?
 <numeric>, <numeric>, <discrete>

Returns: <string>

:SOURce:DATA:TELEcom:SDH:POVerhead:DATA <discrete>, <string>

<discrete> = C2|G1|F2|H4|Z3|F3|Z4|K3|Z5|N1

<string> = "00000000" to "11111111"

Sets the binary value of the specified VC-4-NC/VC-4/VC-3 High Order POH overhead byte. The corresponding query returns the value of the specified STM-1 path overhead byte as a string, as described above.

:SOURce:DATA:TELEcom:SDH:POVerhead:DATA? <discrete>

Returns: <string>

SOURce subsystem - Transmitter SDH OVERHEAD SETUP**:SOURce:DATA:TELEcom:SDH:POVerhead:SLABel <discrete>**

<discrete> =	UNEQuipped	Unequipped (00000000)
	EQUipped	Equipped (00000001)
	TUGStructure	TUG structure (00000010)
	LOCKed	Locked TU (00000011)
	ASYN34	Asynchronous 34 /45 Mb/s (00000100)
	ASYN140	Asynchronous 140 Mb/s (00010010)
	ATM	ATM (00010011)
	DQDB	DQDB (00010100)
	FDDI	FDDI (00010101)
	BULK	Bulk Filled (11111110)
	VCAis	VCAIS
	USER	User Defined

Sets the value of the HP path label (C2 Byte) if foreground payload choice is VC-4 into an AU-4 or VC-3 into an AU-3. To update the USER byte value use the :SOURce:DATA:TELEcom:SDH:POVerhead:DATA <discrete>, <string> command.

The corresponding query returns the value of the C2 byte in discrete short form.

:SOURce:DATA:TELEcom:SDH:POVerhead:SLABel?

Returns: <discrete>

:SOURce:DATA:TELEcom:SDH:POVerhead:J1:PATtern <discrete>

<discrete> =	DEFault	64 NULL characters
	TEST	HP37717C....
	USER	User Defined
	CRC7Test	HP: - GB00000000
	CRC7User	User Defined

SOURce subsystem - Transmitter SDH OVERHEAD SETUP

Sets the type of pattern that is to be transmitted in the J1 byte of the STM-1 path overhead. The pattern repeats every 64 characters (16 chars in CRC7 case) and is transmitted byte by byte in subsequent frames.

The corresponding query returns the type of pattern being transmitted in STM-1 path overhead byte J1 in discrete form as listed above.

:SOURce:DATA:TELEcom:SDH:POVerhead:J1:PATtern?

Returns : <discrete>

:SOURce:DATA:TELEcom:SDH:POVerhead:J1 <string>

Sets the user defined pattern that is to be transmitted in the J1 byte of the STM-1 path overhead. The pattern should be 64 characters long, terminated with CR/LF. If less than 64 characters are input, the instrument will pad with the required number of NULL characters and terminate with CR/LF. The pattern repeats every 64 characters and is transmitted byte by byte in subsequent frames.

The corresponding query returns the value of the user defined pattern as a string, as defined above. If the string contains any non printing characters, ~ is substituted.

If CRC7 was returned in response to

:SOURce:DATA:TELEcom:SDH:POVerhead:J1:PATtern? , this query command is not valid.

:SOURce:DATA:TELEcom:SDH:POVerhead:J1?

Returns : <string>

:SOURce:DATA:TELEcom:SDH:POVerhead:J1:CRC7 <string>

This command sets the CRC7 based user defined string that is to be transmitted using the J1 byte and configures the instrument to use this string. The string can be up to 15 characters in length; remaining characters are set to NULLs. A frame marker byte with CRC7 is added to this string.

The string is transmitted byte by byte in subsequent frames. The string repeats every 16 characters. The corresponding query returns the current value of the string. If the string contains any non printing characters, ~ is substituted.

:SOURce:DATA:TELEcom:SDH:POVerhead:J1:CRC7?

Returns : <string>

SOURce subsystem - Transmitter SDH OVERHEAD SETUP**:SOURce:DATA:TELEcom:SDH:POVerhead:J1:HEXadecimaL?**

Returns : <block>

Returns a 64 byte block of data. Each byte represents the hexadecimal value of an ASCII character of STM-1 path overhead byte J1 in the range "00" to "FF". The 64 hexadecimal numbers are preceded by the header "#264".

If CRC7 was returned in response to

:SOURce:DATA:TELEcom:SDH:POVerhead:J1:PATtern?, this query command is not valid.

:SOURce:DATA:TELEcom:SDH:TRIButary:POVerhead:DATA <discrete>, <string>

<discrete>= C2|G1|F2|H4|F3|K3|N1|N2|K4|V5

<string>= 00000000 to 11111111 not V5
xx00xxx0 to xx11xxx1 for V5

Sets the value of the specified TU-3, TU-12 or TU-11 path overhead byte to the value specified by string (in the range "00000000" to "11111111"). The byte is specified by the first parameter. Only bits 3, 4 and 8 of V5 can be set but an 8 bit string must be sent with the unsettable bits set to x. To set bits 3, 4 and 8 to "1" send "xx11xxx1".

The value of J1 is set by :SOURce:DATA:TELEcom:SDH:POVerhead:J1 <string> and :SOURce:DATA:TELEcom:SDH:POVerhead:J1:PATtern <discrete>.

The corresponding query returns the byte specified by type in string form, as described above.

:SOURce:DATA:TELEcom:SDH:TRIButary:POVerhead:DATA? <discrete>

Returns: <string>

:SOURce:DATA:TELEcom:SDH:OVERhead:J0:PATtern <discrete>

<discrete> =	FIXed	Fixed Byte
	TEST	HP: - GB00000000
	USER	User Defined

Sets the type of pattern that is to be transmitted in the J0 byte of the STM-1 regenerator section overhead. The pattern repeats every 16 characters and is transmitted character by character in subsequent frames.

SOURce subsystem - Transmitter SDH OVERHEAD SETUP

The corresponding query returns the type of pattern being transmitted in overhead byte J0 in discrete short form.

:SOURce:DATA:TELEcom:SDH:OVERhead:J0:PATtern?

Returns: <discrete>

:SOURce:DATA:TELEcom:SDH:OVERhead:J0 <string>

Sets the user defined pattern that is to be transmitted in the J0 byte of the regenerator overhead. The pattern should be 15 characters long. The instrument automatically appends a E.164 CRC character to make up a 16 character sequence. If less than 15 characters are input, the instrument will pad with the required number of NULL characters. The pattern repeats every 16 characters and is transmitted character by character in subsequent frames.

The corresponding query returns the value of the user defined pattern as a string, as defined above. If the string contains any non printing characters, ~ is substituted.

If FIXed was returned in response

to: SOURce:DATA:TELEcom:SDH:OVERhead:J0:PATtern?, this query command is not valid.

:SOURce:DATA:TELEcom:SDH:OVERhead:J0?

Returns: <string>

:SOURce:DATA:TELEcom:SDH:OVERhead:J0:HEXadecimal?

Returns: <block>

Returns a 15 byte block of data. Each byte represents the hexadecimal value of an ASCII character "00" to "FF". The 15 hexadecimal numbers are preceded by the header "#215".

If FIXed was returned in response to

:SOURce:DATA:TELEcom:SDH:OVERhead:J0:PATtern?, this query command is not valid.

:SOURce:DATA:TELEcom:SDH:TRIButary:POVerhead:J1:PATtern <discrete>

<discrete> =	DEFault	64 NULL characters
	TEST	HP37717C Communications....
	USER	User Defined

SOURce subsystem - Transmitter SDH OVERHEAD SETUP

CRC7Test HP: - GB00000000

CRC7User User Defined

Sets the type of pattern that is to be transmitted in the J1 byte of the TU3 path overhead. The pattern repeats every 64 characters (16 chars in CRC7 case) and is transmitted byte by byte in subsequent frames.

The corresponding query returns the type of pattern being transmitted in TU3 path overhead byte J1 in discrete form as listed above.

:SOURce:DATA:TELEcom:SDH:TRIButary:POVerhead:J1:PATtern?

Returns : <discrete>

:SOURce:DATA:TELEcom:SDH:TRIButary:POVerhead:J1 <string>

Sets the user defined pattern that is to be transmitted in the J1 byte of the TU3 path overhead. The pattern should be 64 characters long, terminated with CR/LF. If less than 64 characters are input, the instrument will pad with the required number of NULL characters and terminate with CR/LF. The pattern repeats every 64 characters and is transmitted byte by byte in subsequent frames.

The corresponding query returns the value of the user defined pattern as a string, as defined above. If the string contains any non printing characters, ~ is substituted.

If CRC7T or CRC7U was returned in response to :SOURce:DATA:TELEcom:SDH:POVerhead:J1:PATtern?, this query command is not valid.

:SOURce:DATA:TELEcom:SDH:TRIButary:POVerhead:J1?

Returns : <string>

:SOURce:DATA:TELEcom:SDH:TRIButary:POVerhead:J1:CRC7 <string>

This command sets the CRC7 based user defined string that is to be transmitted using the J1 byte of the TU3 path overhead, and configures the instrument to use this string. The string can be up to 15 characters in length; remaining characters are set to NULLs. A frame marker byte with CRC7 is added to this string. The string is transmitted byte by byte in subsequent frames. The string repeats every 16 characters. The corresponding query returns the current value of the string. If the string contains any non printing characters, ~ is substituted.

SOURce subsystem - Transmitter SDH OVERHEAD SETUP**:SOURce:DATA:TELEcom:SDH:TRIButary:POVerhead:J1:CRc7?**

Returns : <string>

:SOURce:DATA:TELEcom:SDH:TRIButary:POVerhead:J1:HEXadecimal?

Returns : <block>

Returns a 64 byte block of data. Each byte represents the hexadecimal value of an ASCII character of TU3 byte J1 in the range "00" to "FF". The 64 hexadecimal numbers are preceded by the header "#264".

If CRc7T or CRc7U was returned in response to

:SOURce:DATA:TELEcom:SDH:POVerhead:J1:PATtern?, this query command is not valid.

:SOURce:DATA:TELEcom:SDH:TRIButary:POVerhead:J2:PATtern
<discrete>

<discrete> =	DEFault	15 NULL characters
	TEST	HP: - GB(serial number)
	USER	User Defined
	FIXed	Fixed Byte

Sets the type of pattern that is to be transmitted in the J2 byte of the VC-2 or VC-12 path overhead. The pattern repeats every 16 characters and is transmitted byte by byte in subsequent frames.

The corresponding query returns the type of pattern being transmitted in VC-2 or VC-12 path overhead byte J2 in discrete form as listed above.

:SOURce:DATA:TELEcom:SDH:TRIButary:POVerhead:J2:PATtern?

Returns : <discrete>

:SOURce:DATA:TELEcom:SDH:TRIButary:POVerhead:J2 <string>

Sets the user defined pattern that is to be transmitted in the J2 byte of the VC-2 or VC-12 path overhead. The pattern should be 15 characters long. If less than 15 characters are input, the instrument will pad with the required number of NULL characters and a frame marker byte with CRc7 is added to the string. The pattern repeats every 16 characters and is transmitted byte by byte in subsequent frames.

SOURce subsystem - Transmitter SDH OVERHEAD SETUP

The corresponding query returns the value of the user defined pattern as a string, as defined above. If the string contains any non printing characters, ~ is substituted.

:SOURce:DATA:TELEcom:SDH:TRIButary:POVerhead:J2?

Returns : <string>

:SOURce:DATA:TELEcom:SDH:TRIButary:POVerhead:J2:HEXadecimal?

Returns : <block>

Returns a 16 byte block of data. Each byte represents the hexadecimal value of an ASCII character of VC-2 or VC12 byte J2 in the range "00" to "FF". The 15 hexadecimal numbers are preceded by the header "#215".

:SOURce:DATA:TELEcom:SDH:TRIButary:POVerhead:J2:FIXed <string>

<string> = "00000000" to "11111111"

Sets the user defined fixed byte that is to be transmitted in the J2 byte of the VC-2 or VC-12 path overhead. The value is a binary string.

The corresponding query returns the value of the user defined fixed byte as a binary string, as defined above.

:SOURce:DATA:TELEcom:SDH:TRIButary:POVerhead:J2:FIXed?

Returns : <string>

:SOURce:DATA:TELEcom:SDH:TRIButary:POVerhead:V5:SLABel <numeric>

<numeric> = 0 to 7

Sets the VC-2, VC-12 or VC-11 signal label (Byte V5) value.

The corresponding query returns the signal label value in numeric form.

:SOURce:DATA:TELEcom:SDH:TRIButary:POVerhead:V5:SLABel?

Returns : <numeric>

:SOURce:DATA:TELEcom:SDH:TRIButary:POVerhead:C2:SLABel <discrete>

SDH Command Reference

SOURce subsystem - Transmitter SDH OVERHEAD SETUP

<discrete> =	UNEQuipped	Unequipped (00000000)
	EQUipped	Equipped (00000001)
	TUGStructure	TUG structure (00000010)
	LOCKed	Locked TU (00000011)
	ASYN34	Asynchronous 34 /45 Mb/s (00000100)
	ASYN140	Asynchronous 140 Mb/s (00010010)
	ATM	ATM (00010011)
	DQDB	DQDB (00010100)
	FDDI	FDDI (00010101)
	BULK	Bulk Filled (11111110)
	VCAis	VCAIS
	USER	User Defined

SOURce subsystem - Transmitter SDH OVERHEAD SETUP

Sets the LP Path Signal Label (C2 byte) if foreground payload TU-3 into an VC-4 is selected. To update the USER byte value use either the

:SOURce:DATA:TELEcom:SDH:OVERhead:DATA <numeric>, <numeric>,
<discrete>, <string> or the

:SOURce:DATA:TELEcom:SDH:OVERhead:DATA:HEXadecimal <numeric>,
<numeric>, <discrete>, <string> command.

The corresponding query returns the C2 byte value in discrete short form.

The corresponding query returns the C2 byte value in discrete short form.

:SOURce:DATA:TELEcom:SDH:TRIButary:POV:C2:SLABel?

Returns: <discrete>

:SOURce:DATA:TELEcom:SDH:POVerhead:H4Sequence <discrete>

<discrete> =	LONG	Long Sequence
	SHORT	Short Sequence
	COC1	COC1 Sequence

Sets the H4 path overhead byte sequence length when

:SOURce:DATA:TELEcom:SDH:PAYLoad <discrete> is set to "TU2" or "TU12".

The corresponding query returns the H4 byte sequence length in discrete form as listed above.

:SOURce:DATA:TELEcom:SDH:POVerhead:H4Sequence?

Returns : <discrete>

:SOURce:DATA:TELEcom:SDH:OVERhead:SBYTe <discrete>

<discrete> =	QUALunknown	(0000)
	G811	(0010)
	G812Transit	(0100)
	G812Local	(1000)
	SETS	(1011)
	DONTusesync	(1111)
	USER	

SDH Command Reference

SOURce subsystem - Transmitter SDH OVERHEAD SETUP

Selects the SDH SYNC message type (S1 Byte Bits 5 to 8).

The corresponding query returns the Sync Message type in discrete form as listed above.

:SOURce:DATA:TELeom:SDH:OVERhead:SBYTe?

Returns : <discrete>

SOURce subsystem - Transmitter SDH Test Function Commands**:SOURce:DATA:TELEcom:SDH:TFUNction:TYPE <discrete>**

<discrete> =	ERRor	Errors & Alarms
	POINter	Pointer
	SEQuence	Overhead sequences
	STESt	Optical Stress
	MSPMessages	MSP messages
	IDCC	Insert Datacomm
	OBERtest	Overhead BER test

Selects the SDH transmit test function type. STESt is only valid when an optical module is fitted and an optical line rate selected.

The corresponding query returns the test function type in discrete form as listed above.

:SOURce:DATA:TELEcom:SDH:TFUNction:TYPE?

Returns : <discrete>

:SOURce:DATA:TELEcom:SDH:ERRor:TYPE <discrete>

<discrete> =	BIT	bit errors
	FRAMe	A1A2 frame errors
	RSBip	Regenerator section BIP
	MSBip	Multiplexer section BIP
	MSRei or MFEBE	Multiplexer section REI
	PBIP	Path BIP
	HPRei or FEBE	Higher order path REI

SOURce subsystem - Transmitter SDH Test Function Commands

PIEC	Path Incoming Error Count
TUBip or TUBIp	Tributary BIP
LPRei or TUFebe	Lower order path REI

Selects SDH transmit test function error type when

:SOURce:DATA:TELEcom:SDH:TFUNction:TYPE <discrete> is set to "ERR" .
Further selection of :SOURce:DATA:TELEcom:SDH:ERRor:RATE <discrete> is required.

The corresponding query returns the SDH error type in discrete form as listed above.

:SOURce:DATA:TELEcom:SDH:ERRor:TYPE?

Returns : <discrete>

:SOURce:DATA:TELEcom:SDH:ERRor:RATE <discrete>

<discrete> =	NONE	Errors Off
	ONCE	Single Error Add, Not Frame errors
	EALL	Error All (Not Frame)
	MSPThreshold	MSP Threshold (MS Bip only)
	E_3	Bit, MS Bip, MS FEBE, TU Bip & TU FEBE only
	E_4	All except Frame errors
	E_5	All except Frame errors
	E_6	All except Frame errors
	E_7	All except Frame errors
	E_8	All except Frame errors
	E_9	All except Frame errors
	ONE	Frame Errors only
	TWO	Frame Errors only

SOURce subsystem - Transmitter SDH Test Function Commands

THRee	Frame Errors only
FOUR	Frame Errors only

Selects the transmitter SDH Error rate of the error type selected by :SOURce:DATA:TELEcom:SDH:ERRor:TYPE <discrete>. This command is applicable when :SOURce:DATA:TELEcom:SOURce <discrete> is set to SDH.

If bit errors are to be added to the PDH payload then :SOURce:DATA:TELEcom:TFUNction <discrete> must be set to "PDHP".

The corresponding query returns the selected transmitter SDH error rate in discrete form, as listed above.

:SOURce:DATA:TELEcom:SDH:ERRor:RATE?

Returns : <discrete>

:SOURce:DATA:TELEcom:SDH:PDHPayload:ERRor:TYPE <discrete>

<discrete> =	NONE	
	BIT	bit errors
	FAS	PDH frame errors
	MFAS	multiframe errors
	FASMfas	PDH frame and multiframe errors
	CRC	
	PBITs	parity bits errors
	FEBE	
	REBE	
	CPBits	
	EXZ	Excess zeroes

Selects the TX PDH Payload error type.

The corresponding query returns the error type in discrete form as listed above.

SOURce subsystem - Transmitter SDH Test Function Commands**:SOURce:DATA:TELEcom:SDH:PDHPayload:ERRor:TYPE?**

Returns : <discrete>

:SOURce:DATA:TELEcom:SDH:PDHPayload:ERRor:RATE <discrete>

<discrete> =	NONE	No errors added
	ONCE	single error added
	E_3	1.0E-3 error rate
	E_4	1.0E-4 error rate
	E_5	1.0E-5 error rate
	E_6	1.0E-6 error rate
	E_7	1.0E-7 error rate
	USER	User defined error rate

Sets the PDH Payload error rate for the error type selected by

:SOURce:DATA:TELEcom:SDH:PDHPayload:ERRor:TYPE <discrete>.

The corresponding query returns the error rate in discrete form as listed above.

:SOURce:DATA:TELEcom:SDH:PDHPayload:ERRor:RATE?

Returns: <discrete>

**:SOURce:DATA:TELEcom:SDH:PDHPayload:ERRor:RATE:USER
<numeric>**

<numeric>	1.1E-3 to 1.0E-9	mantissa resolution 0.1, exponent resolution 1
-----------	------------------	---

Sets the user defined SDH PDH payload Error Add rate of the error type selected by :SOURce:DATA:TELEcom:SDH:PDHPayload:ERRor:TYPE <discrete> . This command is applicable when :SOURce:DATA:TELEcom:SOURce <discrete> is set to PDHPayload.

SOURce subsystem - Transmitter SDH Test Function Commands

The corresponding query returns the user defined SPDH Error Add rate in numeric form.

:SOURce:DATA:TELEcom:SDH:PDHPayload:ERRor:RATE:USER?

Returns: <numeric>

:SOURce:DATA:TELEcom:SDH:ERRor:MSPThreshold:NERRors <numeric>

<numeric> = 0 to 1920

Sets the number of errors for the MSP Threshold when

:SOURce:DATA:TELEcom:SDH:ERRor:RATE <discrete> is set to "MSPT".

The corresponding query returns the number of errors selected for the MSP Threshold in numeric form.

:SOURce:DATA:TELEcom:SDH:ERRor:MSPThreshold:NERRors?

Returns : <numeric>

:SOURce:DATA:TELEcom:SDH:ERRor:MSPThreshold:EINterval <discrete>

<discrete> =	MS10	10 milliseconds
	MS100	100 milliseconds
	S1	1 second
	S10	10 seconds
	S100	100 seconds
	S1000	1,000 seconds
	S10000	10,000 seconds

Sets the interval between MSP Threshold errors when

:SOURce:DATA:TELEcom:SDH:ERRor:RATE <discrete> is set to "MSPT" .

The corresponding query returns the MSP Threshold error interval in discrete form as listed above.

SOURce subsystem - Transmitter SDH Test Function Commands**:SOURce:DATA:TELEcom:SDH:ERRor:MSPThreshold:EINterval?**

Returns : <discrete>

:SOURce:DATA:TELEcom:SDH:ALARm <discrete>

<discrete> =	NONE	Alarms Off
	LOS	Loss of Signal
	LOF	Loss of Frame
	OOF	Out of Frame
	MSAis	Multiplexer Section AIS
	MSFerf or MSRDi	Multiplexer Section FERF
	LOP	Loss of Pointer
	PAIS	Path AIS
	PFERf or HPRDi	Path FERF
	PUNequipped	Path Unequipped
	TULop	TU Loss of Pointer
	TUPais	TU Path AIS
	TUPFerf or LPRDi	TU Path FERF
	LOMultiframe	Multiframe (H4) Loss
	TUUNequipped	Tributary unequipped

Selects the TX Test Function alarm type when

:SOURce:DATA:TELEcom:SDH:TFUNction:TYPE <discrete> is set to "ERR".

The corresponding query returns the SDH alarm type in discrete form as listed above.

:SOURce:DATA:TELEcom:SDH:ALARm?

Returns : <discrete>

SOURce subsystem - Transmitter SDH Test Function Commands

:SOURce:DATA:TELEcom:SDH:ALARm:SOOFrAm

Generates a single Out Of Frame alarm.

:SOURce:DATA:TELEcom:SDH:POINter <discrete>

<discrete> =	BURSt	Adds bursts
	NPOinter	New Pointer
	OFFSet	Adds offset in ppm
	G783	Adds G.783 sequence

Selects the Pointer adjustment type when

:SOURce:DATA:TELEcom:SDH:TFUNction:TYPE <discrete> is set to "POIN".

The corresponding query returns the pointer adjustment type in discrete form as listed above.

:SOURce:DATA:TELEcom:SDH:POINter?

Returns : <discrete>

:SOURce:DATA:TELEcom:SDH:POINter:TYPE <discrete>

<discrete> =	AU
	TU

Selects the TX pointer type when

:SOURce:DATA:TELEcom:SDH:TFUNction:TYPE <discrete> is set to "POIN".

The corresponding query returns the pointer type in discrete form as listed above.

:SOURce:DATA:TELEcom:SDH:POINter:TYPE?

Returns : <discrete>

:SOURce:DATA:TELEcom:SDH:POINter:DIRection <discrete>

<discrete> =	INCRement
--------------	-----------

SOURce subsystem - Transmitter SDH Test Function Commands

DECRement

ALTErnate

Selects the direction of the pointer burst adjustment when

:SOURce:DATA:TELEcom:SDH:TFUNction:TYPE <discrete> is set to "POIN".

The corresponding query returns the pointer burst direction in discrete form as listed above.

:SOURce:DATA:TELEcom:SDH:POINter:DIRection?

Returns : <discrete>

:SOURce:DATA:TELEcom:SDH:POINter:IDECrement <numeric>

<numeric> =	1 to 10	TU-3, AU-3, AU-4
	1 to 5	TU-2, TU-12, TU-11

Selects the number of places by which the pointer is to be incremented or

decremented when :SOURce:DATA:TELEcom:SDH:TFUNction:TYPE <discrete>

is set to "POIN" and :SOURce:DATA:TELEcom:SDH:POINter <discrete> is set to "BURS" .

The corresponding query returns the number of places in numeric form.

:SOURce:DATA:TELEcom:SDH:POINter:IDECrement?

Returns : <numeric>

:SOURce:DATA:TELEcom:SDH:POINter:TRANsmitted?

Returns: <numeric>

Returns the currently transmitted value of the AU pointer in numeric form.

:SOURce:DATA:TELEcom:SDH:POINter:ACTIon

Forces the new pointer value defined by

:SOURce:DATA:TELEcom:SDH:POINter:VALue <numeric> to be adopted.

SOURce subsystem - Transmitter SDH Test Function Commands

:SOURce:DATA:TELEcom:SDH:POINter:VALue <numeric>

<numeric> = 0 to 782

Selects the AU New Pointer value when

:SOURce:DATA:TELEcom:SDH:TFUNction:TYPE <discrete> is set to "POIN"
and :SOURce:DATA:TELEcom:SDH:POINter <discrete> is set to "NPO".

The corresponding query returns the new pointer value in numeric form as listed above.

:SOURce:DATA:TELEcom:SDH:POINter:VALue?

Returns : <numeric>

:SOURce:DATA:TELEcom:SDH:TRIButary:POINter:TRANsmitted?

Returns: <numeric>

Returns the currently transmitted value of the TU pointer in numeric form.

:SOURce:DATA:TELEcom:SDH:TRIButary:POINter:VALue <numeric>

<numeric> =	0 to 764	for TU-3
	0 to 427	for TU-2
	0 to 139	for TU-12
	0 to 103	for TU-11

Selects the TU New Pointer value when

:SOURce:DATA:TELEcom:SDH:TFUNction:TYPE <discrete> is set to "POIN"
and :SOURce:DATA:TELEcom:SDH:POINter <discrete> is set to "NPO".

The corresponding query returns the new pointer value in numeric form as listed above.

:SOURce:DATA:TELEcom:SDH:TRIButary:POINter:VALue?

Returns : <numeric>

SOURce subsystem - Transmitter SDH Test Function Commands

:SOURce:DATA:TELEcom:SDH:POINter:NPOinter <discrete>

<discrete> =	NDF	With New Data Flag
	NNDF	Without New Data Flag

Selects the type of new pointer when

:SOURce:DATA:TELEcom:SDH:TFUNction:TYPE <discrete> is set to "POIN"
and :SOURce:DATA:TELEcom:SDH:POINter <discrete> is set to "NPO".

The corresponding query returns the type of new pointer in discrete form as listed above.

:SOURce:DATA:TELEcom:SDH:POINter:NPOinter?

Returns : <discrete>

:SOURce:DATA:TELEcom:SDH:POINter:ADJust

Adjust pointer to new settings if :SOURce:DATA:TELEcom:SDH:POINter
<discrete> is set to <BURS> or <NPO> .

:SOURce:DATA:TELEcom:SDH:POINter:OFFSet <discrete>

<discrete> =	SIGNAL	Line offset
	VC4	VC-4 rate offset
	TU	TU rate offset

Determines whether the Output signal rate, VC-4 Rate or TU rate is offset.

The corresponding query returns the signal Rate, which is offset, in discrete form as listed above.

:SOURce:DATA:TELEcom:SDH:POINter:OFFSet?

Returns : <discrete>

:SOURce:DATA:TELEcom:SDH:POINter:OFFSet:RATE <numeric>,<suffix>

<numeric> =	-100 to +100	parts per million
	-0.010 to +0.010	percent

SOURCE subsystem - Transmitter SDH Test Function Commands

<suffix> =	PPM	parts per million
	PCT	percent

Selects the amount of offset applied to the Output Signal Rate or the VC-4 Rate or the TU Rate when :SOURCE:DATA:TELEcom:SDH:TFUNction:TYPE <discrete> is set to "POIN" and :SOURCE:DATA:TELEcom:SDH:POINter <discrete> is set to "OFFS".

The default suffix unit is percent.

The corresponding query returns the offset in PPM.

:SOURCE:DATA:TELEcom:SDH:POINter:OFFSet:RATE?

Returns : <numeric>

:SOURCE:DATA:TELEcom:SDH:POINter:G783 <discrete>

<discrete> =	PASingle	Periodic alternate single (a)
	WADDed	Periodic with added (b)
	WCANcelled	Periodic with cancelled (c)
	DOUBle	Periodic alternate double (d)
	RSINGle	Repeating single (e)
	RBURst	Repeating burst (f)
	RPTRansient	Repeating phase transient
	PNORmal	Periodic normal (g/h)
	PADDed	Periodic added (g/h)
	PCANcelled	Periodic cancelled (g/h)
	SINGle	(Obsolete) Set according to value of G783:SINGLE

Selects the G.783 Pointer sequence adjustment type when :SOURCE:DATA:TELEcom:SDH:TFUNction:TYPE <discrete> is set to "POIN" and :SOURCE:DATA:TELEcom:SDH:POINter <discrete> is set to "G783".

SOURce subsystem - Transmitter SDH Test Function Commands

The corresponding query returns the G.783 adjustment type in discrete form as listed above.

:SOURce:DATA:TELEcom:SDH:POINter:G783?

Returns : <discrete>

:SOURce:DATA:TELEcom:SDH:POINter:G783:SINGLE <discrete>

<discrete> =	APOLarity	Periodic alternate single
	WCANcelled	With Cancelled
	WADDed	With Added

(Obsolete) Set the type of G.783 pointer sequence when :SOURce:DATA:TELEcom:SDH:TFUNction:TYPE <discrete> is set to "POIN" and :SOURce:DATA:TELEcom:SDH:POINter <discrete> is set to "G783" and :SOURce:DATA:TELEcom:SDH:POINter:G783 <discrete> is set to "SING".

The corresponding query returns the type in discrete form as listed above.

:SOURce:DATA:TELEcom:SDH:POINter:G783:SINGLE?

Returns : <discrete>

:SOURce:DATA:TELEcom:SDH:POINter:G783:PATTern <discrete>

<discrete> =	CONTInuous	No pattern
	P873	87:3 pattern
	P261	26:1 pattern

Selects the pattern of the G.783 pointer sequence when :SOURce:DATA:TELEcom:SDH:TFUNction:TYPE <discrete> is set to "POIN" and :SOURce:DATA:TELEcom:SDH:POINter <discrete> is set to "G783" and :SOURce:DATA:TELEcom:SDH:POINter:G783 <discrete> is set to "PNOR", "PADD" or "PCAN".

The corresponding query returns the G.783 pattern in discrete form as listed above.

SOURce subsystem - Transmitter SDH Test Function Commands**:SOURce:DATA:TELEcom:SDH:POINter:G783:PATtern?**

Returns : <discrete>

:SOURce:DATA:TELEcom:SDH:POINter:G783:POLarity <discrete>

<discrete> =	NEGative
	POSitive

Selects the polarity of the G.783 pointer sequence when

:SOURce:DATA:TELEcom:SDH:TFUNction:TYPE <discrete> is set to "POIN"

and :SOURce:DATA:TELEcom:SDH:POINter <discrete> is set to "G783" and

:SOURce:DATA:TELEcom:SDH:POINter:G783 <discrete> is set to "SING".

The corresponding query returns the G.783 polarity in discrete form as listed above.

:SOURce:DATA:TELEcom:SDH:POINter:G783:POLarity?

Returns : <discrete>

:SOURce:DATA:TELEcom:SDH:POINter:G783:INTerval <numeric>,<suffix>

<numeric> =	numeric	See text
<suffix> =	MS	milliseconds
	S	seconds

Selects the interval between G.783 adjustments.

(AU-4, AU-3, TU-3) Range is 7.5ms, 10ms, 20ms, 30ms, 34ms, 40ms to 100ms in 10ms steps. 100 ms to 1s in 100ms steps. 1s, 2s, 5s and 10s.

(TU-2, TU-12, TU-11) Range is 200ms, 500ms, 1s, 2s, 5s and 10s.

The corresponding query returns the G.783 interval as listed above.

The default suffix unit is seconds.

:SOURce:DATA:TELEcom:SDH:POINter:G783:INTerval?

Returns : <numeric>, <suffix>

SOURce subsystem - Transmitter SDH Test Function Commands

:SOURce:DATA:TELEcom:SDH:POINter:G783:SEQuence <discrete>

<discrete> =	STOP	Stop the current G.783 pointer sequence
	START	Start a G.783 pointer sequence
	INITialize	Start a G.783 pointer sequence preceded by initialization and cooldown

Stops/Starts the G.783 pointer sequence.

The corresponding query returns the sequence start state in discrete form as listed above. See also STAT:SDH2.

:SOURce:DATA:TELEcom:SDH:POINter:G783:SEQuence?

Returns : <discrete>

:SOURce:DATA:TELEcom:SDH:SEQuence <discrete>

<discrete> =	STOP	Stop current sequence
	START	Start new sequence

Starts/Stops a Single or Repeat run Sequence.

The corresponding query returns the Sequence mode in discrete form as listed above.

:SOURce:DATA:TELEcom:SDH:SEQuence?

Returns : <discrete>

:SOURce:DATA:TELEcom:SDH:SEQuence:MODE <discrete>

<discrete> =	SINGLE	Single Run
	REPeat	Repeat Run

Selects the type of SEQUENCE when

:SOURce:DATA:TELEcom:SDH:TFUNction:TYPE <discrete> is set to SEQ.

The corresponding query returns the type of Sequence in discrete form as listed above.

SOURce subsystem - Transmitter SDH Test Function Commands**:SOURce:DATA:TELEcom:SDH:SEQuence:MODE?**

Returns : <discrete>

:SOURce:DATA:TELEcom:SDH:SEQuence:CHANnel <discrete>

<discrete> =	A1A2 C1 J0 Z0 E1 F1 D1D3	Regenerator Overhead
	K1K2 D4D12 S1 Z1_1 Z1_2 Z1_3 Z2_4/M1 Z2_5 Z2_6 M1 E2	Multiplexer Overhead
	J1 C2 G1 F2 H4 Z3/F3 Z4/K3 Z5/N1	Path Overhead

This command is retained for backwards compatibility only. It is recommended that use is made of the newer command

:SOURce:DATA:TELEcom:SDH:SEQuence:OHBYte <discrete>. Selects the overhead byte in which the SEQUENCE is to be inserted when

:SOURce:DATA:TELEcom:SDH:TFUNction:TYPE <discrete> is set to SEQ. C1 is now interpreted as the J0 byte.

Z0 byte is only available if Option 130 is fitted and STM-4 is selected.

The corresponding query returns the byte identity in discrete form as listed above.

:SOURce:DATA:TELEcom:SDH:SEQuence:CHANnel?

Returns : <discrete>

:SOURce:DATA:TELEcom:SDH:SEQuence:OHBYte <discrete>

<discrete> =	A1A2 J0 Z0 E1 F1 D1D3	Regenerator Overhead
	K1K2 D4D12 S1 Z1 Z2 M1 E2	Multiplexer Overhead
	J1 C2 G1 F2 H4 F3 K3 N1	Path Overhead

SOURce subsystem - Transmitter SDH Test Function Commands

Selects the overhead byte into which the overhead sequence is to be inserted when :SOURce:DATA:TELEcom:SDH:TFUNction:TYPE <discrete> is set to SEQ. Some of the parameters are only available in certain columns or STM-1 channels.

The corresponding query returns the sequenced byte in discrete form as listed above.

:SOURce:DATA:TELEcom:SDH:SEQuence:OHBYte?

Returns: <discrete>

:SOURce:DATA:TELEcom:SDH:SEQuence:COLumn <numeric>

<numeric> 1 to 9 Column in Section overhead of byte to sequence.

Sets the column of the Section Overhead of the byte to be sequenced.

The corresponding query returns the column in numeric form.

:SOURce:DATA:TELEcom:SDH:SEQuence:COLumn?

Returns: <numeric>

:SOURce:DATA:TELEcom:SDH:SEQuence:CHANnel:SElect <numeric>

<numeric> = 1 to 4

Only valid if Option 130 is fitted and STM-4 selected. Selects STM-1 number for channels that occur in more than one STM-1:

The corresponding query returns the STM-1 number in numeric form.

:SOURce:DATA:TELEcom:SDH:SEQuence:CHANnel:SElect?

Returns: <numeric>

:SOURce:DATA:TELEcom:SDH:SEQuence:DATA <discrete>, <string>

<discrete> = A | B | C | D | E

<string> = "00" to "FFFFFFFFFFFFFFFF"

Sets the Sequence data pattern for the designated block to the hexadecimal value contained in the string. The number of hexadecimal characters is dependent on the

SOURce subsystem - Transmitter SDH Test Function Commands

overhead byte or bytes selected. Two hexadecimal characters are required per byte, for Example:

E1 - 1 byte "00" to "FF"

D4D12 - 9 bytes "000000000000000000" to "FFFFFFFFFFFFFFFFFFFF"

The corresponding query returns the hexadecimal value of the designated block as a string.

:SOURce:DATA:TELEcom:SDH:SEQuence:DATA? <discrete>

Returns : <string>

:SOURce:DATA:TELEcom:SDH:SEQuence:ORDeR <discrete>, <discrete>, <discrete>, <discrete>, <discrete>

<discrete> = A | B | C | D | E

Selects the order of transmission for the blocks of data used in the sequence.

The corresponding query returns the block order in discrete form as listed above.

:SOURce:DATA:TELEcom:SDH:SEQuence:ORDeR?

Returns : <discrete>, <discrete>, <discrete>, <discrete>, <discrete>

:SOURce:DATA:TELEcom:SDH:SEQuence:FCOunt <numeric>, <numeric>

<numeric> = 1 to 5 Block number
(first parameter)

<numeric> = 0 to 64000 Frame count
(second parameter)

Selects the number of frames in which the block of data, designated by the block_no, is to be transmitted.

The corresponding query returns the frame count of the block specified in numeric form.

SOURce subsystem - Transmitter SDH Test Function Commands**:SOURce:DATA:TELEcom:SDH:SEQuence:FCOunt? <numeric>****<numeric>=** 1 to 5 Block number

Returns : <numeric> Frame count

:SOURce:DATA:TELEcom:SDH:STESt:SPATtern <discrete>**<discrete> =** AZERos All Zero's pattern

AONes All Ones pattern

G958 G.958 sequence

Selects the pattern used in the STM-1 Optical stress test when

:SOURce:DATA:TELEcom:SDH:TFUNction:TYPE <discrete> is set to STES.

The corresponding query returns the selected pattern in discrete form as listed above.

:SOURce:DATA:TELEcom:SDH:STESt:SPATtern?

Returns : <discrete>

:SOURce:DATA:TELEcom:SDH:STESt:BLENght <numeric>**<numeric> =** 0 to 88 STM-0

0 to 259 STM-1

0 to 1042 STM-4

Selects the block length used in the STM-1 Optical stress test when

:SOURce:DATA:TELEcom:SDH:TFUNction:TYPE <discrete> is set to STES.

The corresponding query returns the block length in numeric form.

:SOURce:DATA:TELEcom:SDH:STESt:BLENght?

Returns : <numeric>

SOURce subsystem - Transmitter SDH Test Function Commands

:SOURce:DATA:TELEcom:SDH:MSPMessages:TOPology <discrete>

<discrete> =	LINEar	Linear protection
	RING	Ring protection

Selects the type of protection topology.

The corresponding query returns the selected protection topology in discrete short form.

:SOURce:DATA:TELEcom:SDH:MSPMessages:TOPology?

Returns: <discrete>

:SOURce:DATA:TELEcom:SDH:MSPMessages:REQuest <discrete>

<discrete> =	NREQuest	No Request (0000)
	DNRevert	Do Not Revert (0001)
	RREQuest	Reverse Request (0010)
	THRee	Not Used (0011)
	EXERcise	Exercise (0100)
	FIVE	Not Used (0101)
	WTRestore	Wait To Restore (0110)
	SEVen	Not Used (0111)
	MSWitch	Manual Switch (1000)
	NINE	Not Used (1001)
	SDLPriority	Signal Degrade Low Priority (1010)
	SDHPriority	Signal Degrade High Priority (1011)
	SFLPriority	Signal Fail Low Priority (1100)
	SFHPriority	Signal Fail High Priority (1101)

SOURce subsystem - Transmitter SDH Test Function Commands

FSWitch	Forced Switch (1110)
---------	----------------------

LOPRotection	Lockout Of Protection (1111)
--------------	------------------------------

Selects the transmitter SDH MSP message to be transmitted (K1 Byte, Bits 1 to 4). Only valid if :SOURce:DATA:TELEcom:TFUNction <discrete> is set to SDH and :SOURce:DATA:TELEcom:SDH:TFUNction:TYPE <discrete> is set to MSPM. SDHP and SFHP are only valid when :SOURce:DATA:TELEcom:SDH:MSPMessages:ARCHitecture <discrete> is set to OTN.

The corresponding query returns the selected transmitter SDH MSP message type in discrete form, as listed above.

:SOURce:DATA:TELEcom:SDH:MSPMessages:REQuest?

Returns :	<discrete>
-----------	------------

:SOURce:DATA:TELEcom:SDH:MSPMessages:CHANnel <numeric>

<numeric> =	0	NULL Channel
	1	Working Channel 1
	2	Working Channel 2
	3	Working Channel 3
	4	Working Channel 4
	5	Working Channel 5
	6	Working Channel 6
	7	Working Channel 7
	8	Working Channel 8
	9	Working Channel 9
	10	Working Channel 10
	11	Working Channel 11
	12	Working Channel 12

SOURCE subsystem - Transmitter SDH Test Function Commands

13	Working Channel 13
14	Working Channel 14
15	Extra Traffic Channel

Selects the transmitter SDH MSP message channel (K1 Byte, Bits 5 to 8). Only valid if `:SOURCE:DATA:TELECOM:TFUNCTION <discrete>` is set to SDH and `:SOURCE:DATA:TELECOM:SDH:TFUNCTION:TYPE <discrete>` is set to MSPM

Working Channel 1 to 14 are only valid if `:SOURCE:DATA:TELECOM:SDH:MSPMESSAGES:ARCHITECTURE <discrete>` is set to OTN.

The corresponding query returns the selected transmitter SDH MSP message channel in numeric form, as listed above.

:SOURCE:DATA:TELECOM:SDH:MSPMESSAGES:CHANNEL?

Returns : <numeric>

:SOURCE:DATA:TELECOM:SDH:MSPMESSAGES:BRIDGE <string>

<string> = "0000" to "1111"

Selects the SDH transmitter Linear MSP message bridged channel (K2 Byte, Bits 1 to 4). Only valid if `:SOURCE:DATA:TELECOM:TFUNCTION <discrete>` is set to SDH and `:SOURCE:DATA:TELECOM:SDH:TFUNCTION:TYPE <discrete>` is set to MSPM and `:SOURCE:DATA:TELECOM:SDH:MSPMESSAGES:TOPOLOGY <discrete>` is set to LIN. The corresponding query returns the MSP messages bridged channel as a string as listed above.

:SOURCE:DATA:TELECOM:SDH:MSPMESSAGES:BRIDGE?

Returns : <string>

:SOURCE:DATA:TELECOM:SDH:MSPMESSAGES:ARCHITECTURE <discrete>

<discrete> =	OTONE	1+1
	OTN	1:N

SOURce subsystem - Transmitter SDH Test Function Commands

Selects the SDH transmitter Linear MSP architecture (K2 Byte, Bit 5). Only valid if :SOURce:DATA:TELEcom:TFUNction <discrete> is set to SDH and :SOURce:DATA:TELEcom:SDH:TFUNction:TYPE <discrete> is set to MSPM and :SOURce:DATA:TELEcom:SDH:MSPMessages:TOPology <discrete> is set to LIN.

The corresponding query returns the selected transmitter SDH MSP message architecture in discrete form, as listed above.

:SOURce:DATA:TELEcom:SDH:MSPMessages:ARCHitecture?

Returns : <discrete>

:SOURce:DATA:TELEcom:SDH:MSPMessages:REServed <numeric>

<numeric> =	0	000
	1	001
	2	010
	3	011
	4	100
	5	101

Selects the SDH transmitter Linear MSP messages reserved bits (K2 Byte, Bits 6 to 8) in numeric form. Only valid if :SOURce:DATA:TELEcom:TFUNction <discrete> is set to SDH and :SOURce:DATA:TELEcom:SDH:TFUNction:TYPE <discrete> is set to MSPM and :SOURce:DATA:TELEcom:SDH:MSPMessages:TOPology <discrete> is set to LIN.

The corresponding query returns the selected transmitter SDH MSP message reserved bits in numeric form.

:SOURce:DATA:TELEcom:SDH:MSPMessages:REServed?

Returns: <numeric>

:SOURce:DATA:TELEcom:SDH:MSPMessages:RCODE <discrete>

<discrete> =	NREQuest	No Request (0000)
	RRRING	Reverse Request - Ring (0001)
	RRSPan	Reverse Request - Span (0010)

SOURce subsystem - Transmitter SDH Test Function Commands

ERINg	Exerciser - Ring (0011)
ESPan	Exerciser - Span (0100)
WTRestore	Wait to Restore (0101)
MSRing	Manual Switch - Ring (0110)
MSSPan	Manual Switch - Span (0111)
SDRing	Signal Degrade - Ring (1000)
SDSPan	Signal Degrade - Span (1001)
SDPRotectioN	Signal Degrade - Protection (1010)
SFRing	Signal Fail - Ring (1011)
SFSPan	Signal Fail - Span (1100)
FSRing	Forced Switch Ring (1101)
FSSPan	Forced Switch - Span(1110)
LOPRotectioN	Lockout Of Protection (1111)

Selects the transmitter Ring MSP message to be transmitted (K1 Byte, Bits 1 to 4). Only valid if :SOURce:DATA:TELEcom:TFUNctioN <discrete> is set to SDH and :SOURce:DATA:TELEcom:SDH:TFUNctioN:TYPE <discrete> is set to MSPM and topology is set to RING.

The corresponding query returns the selected transmitter SDH MSP message type in discrete short form.

:SOURce:DATA:TELEcom:SDH:MSPMessages:RCODE?

Returns: <discrete>

:SOURce:DATA:TELEcom:SDH:MSPMessages:DNODE <string>

<string> = "0000" to "1111"

Selects the SDH transmitter Ring MSP message destination node (K1 Byte, Bits 5 to 8). Only valid if :SOURce:DATA:TELEcom:TFUNctioN <discrete> is set to SDH and :SOURce:DATA:TELEcom:SDH:TFUNctioN:TYPE <discrete> is set to MSPM and :SOURce:DATA:TELEcom:SDH:MSPMessages:TOPology <discrete> is set to RING.

The corresponding query returns the MSP messages destination node as a string as listed above.

SOURce subsystem - Transmitter SDH Test Function Commands**:SOURce:DATA:TELEcom:SDH:MSPMessages:DNODE?**

Returns: <string>

:SOURce:DATA:TELEcom:SDH:MSPMessages:SNODE <string>

<string> = "0000" to "1111"

Selects the SDH transmitter Ring MSP message source node (K2 Byte, Bits 1 to 4). Only valid if :SOURce:DATA:TELEcom:TFUNction <discrete> is set to SDH and :SOURce:DATA:TELEcom:SDH:TFUNction:TYPE <discrete> is set to MSPM and :SOURce:DATA:TELEcom:SDH:MSPMessages:TOPology <discrete> is set to RING.

The corresponding query returns the MSP messages source node as a string as listed above.

:SOURce:DATA:TELEcom:SDH:MSPMessages:SNODE?

Returns: <string>

:SOURce:DATA:TELEcom:SDH:MSPMessages:PCODE <discrete>

<discrete> =	SHORT	Short path
	LONG	Long path

Selects the SDH transmitter Ring MSP message path type (K2 bit 5). Only valid if :SOURce:DATA:TELEcom:TFUNction <discrete> is set to SDH and :SOURce:DATA:TELEcom:SDH:TFUNction:TYPE <discrete> is set to MSPM and :SOURce:DATA:TELEcom:SDH:MSPMessages:TOPology <discrete> is set to RING. The corresponding query returns the Ring MSP messages path type in discrete short form.

:SOURce:DATA:TELEcom:SDH:MSPMessages:PCODE?

Returns: <discrete>

:SOURce:DATA:TELEcom:SDH:MSPMessages:SCODE <discrete>

<discrete> =	IDLE	Idle (000)
	BRIDged	Bridged (001)
	BASWitched	Bridged & Switched (010)

SOURce subsystem - Transmitter SDH Test Function Commands

P011	011
P100	100
P101	101

Selects the SDH transmitter Ring MSP messages status code (K2 Byte, Bits 6 to 8). Only valid if :SOURce:DATA:TELEcom:TFUNction <discrete> is set to SDH and :SOURce:DATA:TELEcom:SDH:TFUNction:TYPE <discrete> is set to MSPM and :SOURce:DATA:TELEcom:SDH:MSPMessages:TOPology <discrete> is set to RING.

The corresponding query returns the selected transmitter SDH MSP message status code in discrete form as listed above.

:SOURce:DATA:TELEcom:SDH:MSPMessages:SCODE?

Returns: <discrete>

:SOURce:DATA:TELEcom:SDH:MSPMessages:DOWNload

Start transmission of the SDH transmitter MSP message. Only valid if :SOURce:DATA:TELEcom:TFUNction <discrete> is set to SDH and :SOURce:DATA:TELEcom:SDH:TFUNction:TYPE <discrete> is set to MSPM.

:SOURce:DATA:TELEcom:SDH:IDCC <discrete>

<discrete> =	RDCC	Regenerator DCC
	MDCC	Multiplexer DCC

Selects the Data Communication Channel Insert port when :SOURce:DATA:TELEcom:SDH:TFUNction:TYPE <discrete> is set to IDCC . The corresponding query returns the selected port in discrete form as listed above.

:SOURce:DATA:TELEcom:SDH:IDCC?

Returns : <discrete>

:SOURce:DATA:TELEcom:SDH:IDCC:POLarity <discrete>

<discrete> =	REVERsed
	NORMAl

SDH Command Reference

SOURce subsystem - Transmitter SDH Test Function Commands

Selects the polarity of the DCC Insert port and the DCC Drop port when :SOURce:DATA:TELEcom:SDH:TFUNction:TYPE <discrete> is set to IDCC .

The corresponding query returns the port polarity in discrete form as listed above.

:SOURce:DATA:TELEcom:SDH:IDCC:POLarity?

Returns <discrete>

:SOURce:DATA:TELEcom:SDH:OBERtest:CHANnel <discrete>

<discrete> =	C1 J0 Z0 E1 F1 D1 D2 D3	Regenerator Overhead
	K1 K2 D4 D5 D6 D7	Multiplexer Overhead
	D8 D9 D10 D11 D12	
	S1 Z1 M1 E2	
	J1 C2 G1 F2 H4 Z3/F3	Path Overhead
	Z4/K3 Z5/N1	

Selects the TX overhead byte used for the overhead BER test when :SOURce:DATA:TELEcom:SDH:TFUNction:TYPE <discrete> is set to OBER.

Z0 byte is only available if Option 130 is fitted and STM-4 is selected.

The corresponding query returns the overhead byte identity in discrete form as listed above.

:SOURce:DATA:TELEcom:SDH:OBERtest:CHANnel?

Returns <discrete>

:SOURce:DATA:TELEcom:SDH:OBERtest:COLumn <numeric>

<numeric> 1 to 3

Sets the column number of the Section Overhead byte currently selected for the overhead bit transmitter error rate test function. This command is only valid if :SOURce:DATA:TELEcom:SDH:TFUNction:TYPE <discrete> is set to OBER . The column are 1 for 1,4,7; 2 for 2,5,8 and 3 for 3,6,9.

The corresponding query returns the column number in numeric form as described above.

SOURCE subsystem - Transmitter SDH Test Function Commands

:SOURCE:DATA:TELEcom:SDH:OBERTest:COLumn?

Returns: <numeric>

:SOURCE:DATA:TELEcom:SDH:OBERTest:CHANnel:SElect <numeric>

<numeric> =	1	All bytes
	2	Z0
	3	Z0, M1
	4	Z0

Only valid if Option 130 is fitted and STM-4 is selected. Selects STM-1 number for channels that occur in more than one STM-1:

The corresponding query returns the STM-1 number in numeric form.

:SOURCE:DATA:TELEcom:SDH:OBERTest:CHANnel:SElect?

Returns: <numeric>

:SOURCE:DATA:TELEcom:SDH:OBERTest <discrete>

<discrete> =	ONCE	Single error
--------------	------	--------------

Injects a single overhead BER error when

:SOURCE:DATA:TELEcom:SDH:TFUNction:TYPE <discrete> is set to OBER

INPut subsystem

INPut subsystem

This subsystem controls the characteristics of the instrument's input ports.

:INPut:TELEcom:SDH:RATE <discrete>

<discrete> =	STM0	STM-0 Electrical
	STM1	STM-1 Electrical

Is only valid when the SDH Module is fitted and :SENSe:DATA:TELEcom:SENSe <discrete> is set to SDH.

The corresponding query returns the SDH rate in discrete short form.

:INPut:TELEcom:SDH:RATE?

Returns : <discrete>

:INPut:TELEcom:SDH:LEVel <discrete>

<discrete> =	HIGH	0 feet simulated cable
	LOW	900 feet simulated cable

Selects the signal level for the STM-0 input. Is only valid when the SDH Module is fitted and :INPut:TELEcom:SDH:RATE <discrete> is set to STM0.

The corresponding query returns the STM-0 signal level in discrete short form.

:INPut:TELEcom:SDH:LEVel?

Returns: <discrete>

:INPut:TELEcom:SDH:GAIN <discrete>

<discrete> =	DB20	20 dB Gain
	DB26	26 dB Gain

Selects the Monitor gain for the SDH receiver. Only valid when :INPut:TELEcom:LEVel <discrete> is set to MON.

The corresponding query returns the Monitor gain in discrete short form.

INPut subsystem**:INPut:TELEcom:SDH:GAIN?**

Returns: <discrete>

:INPut:TELEcom:OPT1:RATE?

Returns : <discrete> STM1

Always returns STM1. Is only valid when Option UH1, STM-1 Optical Interface, is fitted and :SENSe:DATA:TELEcom:SENSe <discrete> is set to OPT1.

:INPut:TELEcom:OPT4:RATE <discrete>

<discrete> =	STM0	STM-0 optical
	STM1	STM-1 Optical
	STM4	STM-4 Optical

Sets the input rate for the STM-0/STM-1/STM-4 optical input port. Is only valid when Option STM-0/STM-1/STM-4 Optical Interface is fitted and :SENSe:DATA:TELEcom:SENSe <discrete> is set to OPT4.

The corresponding query returns the STM-0/STM-1/STM-4 input rate in discrete form, as listed above.

:INPut:TELEcom:OPT4:RATE?

Returns : <discrete>

:INPut:TELEcom:OPT4:INTErface:BINary:CLOCK:POLarity <discrete>

<discrete> =	INVerted	Clock inverted
	NORMAl	Clock not inverted

Selects the polarity of the binary clock input to the Optical modules and is only valid if option 0YH is fitted.

The corresponding query returns the polarity of the binary clock input in discrete form, as listed above.

INPut subsystem

:INPut:TELEcom:OPT4:INTerface:BINary:CLOCK:POLarity?

Returns : <discrete>

:INPut:TELEcom:OPT4:INTerface:BINary:DATA:POLarity <discrete>

<discrete> =	INVerted	Data inverted
	NORMAl	Data not inverted

Selects the polarity of the binary data input to the Optical modules and is only valid if option 0YH is fitted.

The corresponding query returns the polarity of the binary data input in discrete form, as listed above.

:INPut:TELEcom:OPT4:INTerface:BINary:DATA:POLarity?

Returns : <discrete>

:INPut:TELEcom:OPT4:INTerface <discrete>

<discrete> =	OPTical	Optical input
	MONitor	Protected Monitor Input
	BINary	Binary input

Selects the input interface on the Optical modules. BINary is only valid if option 0YH is fitted.

The corresponding query returns the input interface in discrete form, as listed above.

:INPut:TELEcom:OPT4:INTerface?

Returns: <discrete>

INPut subsystem

SENSe subsystem - Receiver SDH Settings

SDH Mapping settings

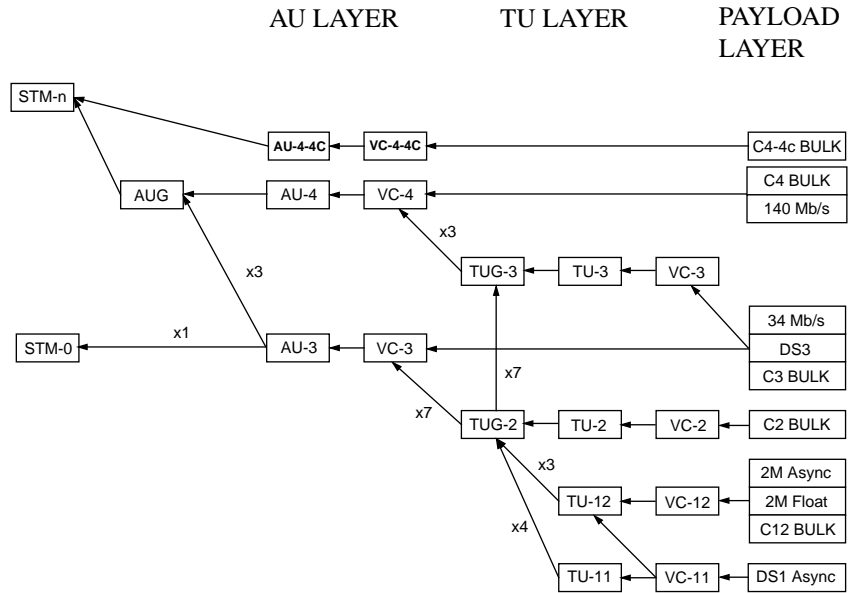

:SENSe:DATA:TELEcom:SDH:VC4 <numeric>

<numeric> = 1 to 4 VC4 under test

Selects the STM-1 VC4 within an STM-N or test. Only valid if :INPut:TELEcom:OPT4:RATE <discrete> is set a rate higher than STM1.

The corresponding query returns the test VC4 number.

:SENSe:DATA:TELEcom:SDH:VC4?

Returns : <numeric>

SDH Command Reference
SENSe subsystem - Receiver SDH Settings

AU Layer Selection

:SENSe:DATA:TELEcom:SDH:AU:TYPE <discrete>

<discrete> = AU4
AU3
AU4_4C

Set the AU mapping into an STM-N frame.

The corresponding query returns the AU type in discrete form as listed above.

:SENSe:DATA:TELEcom:SDH:AU:TYPE?

Returns: <discrete>

:SENSe:DATA:TELEcom:SDH:AU3 <numeric>

<numeric> = 1 to 3 AU3 Number

Selects the SDH Receiver active AU3 within the AUG.

The corresponding query returns the active AU3 in numeric form.

:SENSe:DATA:TELEcom:SDH:AU3?

Returns : <numeric>

TU Layer Selection

:SENSe:DATA:TELEcom:SDH:PAYLoad <discrete>

<discrete> =	VC4 <i>or</i> M140	140 Mb/s
	VC3	STM-0
	TU3 <i>or</i> M34	34 Mb/s
	TU12 <i>or</i> M2	2 Mb/s
	TU2	VC-2
	VC_4C	Option 130/131 Only
	TU11 <i>or</i> DS1	TU-11

SDH Command Reference

SENSe subsystem - Receiver SDH Settings

This command selects the SDH receiver mapping

The corresponding query returns the mapping in discrete form, as listed above.

:SENSe:DATA:TELEcom:SDH:PAYLoad?

Returns : <discrete>

Payload Layer Selection

:SENSe:DATA:TELEcom:SDH:MAPPing <discrete>

<discrete> =	M140	140 Mb/s - AU-4 (C-4 only)
	M34	34 Mb/s - VC-3 (C-3 only)
	DS3	DS3 - VC-3 (C-3 only)
	BULK	Bulk Filled (C-4 or C-3)

Selects the Receiver SDH payload for single payload cases. Only valid if :SENSe:DATA:TELEcom:SDH:PAYLoad <discrete> is set to VC3 or VC4.

The corresponding query returns the payload in discrete form as listed above.

:SENSe:DATA:TELEcom:SDH:MAPPing?

Returns: <discrete>

:SENSe:DATA:TELEcom:SDH:TRIButary:MAPPing <discrete>

<discrete> =	ASYNc or ASM2	2 Mb/s
	FBYTe or FLM2	2 Mb/s Floating Byte
	M34 or ASM34	34 Mb/s
	DS1 or ASDS1	Asynchronous 1.544 Mb/s DS1
	DS3 or ASDS3	Asynchronous 44.736 Mb/s DS3
	BULK	Bulk Filled

Selects the low order mapping. Only valid if

:SENSe:DATA:TELEcom:SDH:PAYLoad <discrete> is set to TU3, TU12 or TU11.

The corresponding query returns the low order mapping in discrete short form.

SENSe subsystem - Receiver SDH Settings

:SENSe:DATA:TELEcom:SDH:TRIButary:MAPPing?

Returns: <discrete>

:SENSe:DATA:TELEcom:SDH:PRIMary:TS0 <boolean>

<boolean> = 0 or OFF Data in TS0
1 or ON Signaling in TS0

Determines the content of TS0 as Data/Signaling.

The corresponding query returns the TS0 state in numeric form.

:SENSe:DATA:TELEcom:SDH:PRIMary:TS0?

Returns : <boolean>

TUG Channel

:SENSe:DATA:TELEcom:SDH:TUG3 <numeric>

<numeric> = 1 to 3

Selects the SDH Receiver active TUG3 within the AU4.

The corresponding query returns the active TUG-3 number in numeric form.

:SENSe:DATA:TELEcom:SDH:TUG3?

Returns : <numeric>

:SENSe:DATA:TELEcom:SDH:TUG2 <numeric>

<numeric> = 1 to 7

Selects the SDH Receiver active TUG2 within the selected TUG3 or AU3.

The corresponding query returns the TUG2 number in numeric form.

SDH Command Reference
SENSe subsystem - Receiver SDH Settings

:SENSe:DATA:TELEcom:SDH:TUG2?

Returns : <numeric>

:SENSe:DATA:TELEcom:SDH:TRIButary <numeric>

<numeric> = 1 to 3 Tributary number for TU-12
1 to 4 Tributary number for TU-11

Selects the SDH Receiver active TU within the selected TUG2.
The corresponding query returns the receiver test tributary in numeric form.

:SENSe:DATA:TELEcom:SDH:TRIButary?

Returns : <numeric>

TU Payload and Test Pattern

:SENSe:DATA:TELEcom:SDH:PAYLoad:TYPE <discrete>

<discrete> =	UNFRamed	No framing
	FRAMed	8, 34 & 140 Mb/s
	PCM30	2 Mb/s
	PCM31	2 Mb/s
	PCM30CRC	2 Mb/s
	PCM31CRC	2 Mb/s
	DM2	Drop 2 Mb/s
	DM34	Drop 34 Mb/s
	DM140	Drop 140 Mb/s
	D4	DS1 Framing
	ESF	DS1 Framing
	SLC96	DS1 Framing

SENSe subsystem - Receiver SDH Settings

M13	DS3 Framing
CBIT	DS3 Framing
DDS1	Drop DS1
DDS3	Drop DS3

Note: This command is not backwards compatible. To set the framing type to be structured use the command `:SENSe:DATA:TELEcom:SDH:PAYLoad:STRucture <discrete>`.

Only valid if a Structured PDH receiver is fitted.

The corresponding query returns the framing in discrete form as listed above.

:SENSe:DATA:TELEcom:SDH:PAYLoad:TYPE?

Returns : <discrete>

:SENSe:DATA:TELEcom:SDH:PAYLoad:STRucture <discrete>

<discrete> =	UNSTructured	All rates
	STRuctured	All framed formats

Determines whether the receiver is to expect any structure in the PDH payload.

The corresponding query returns the receiver structure setting in discrete form as listed above.

:SENSe:DATA:TELEcom:SDH:PAYLoad:STRucture?

Returns: <discrete>

:SENSe:DATA:TELEcom:SDH:PAYLoad:PATTern <discrete>

<discrete> =	PRBS9	2^9-1
	PRBS11	$2^{11}-1$
	PRBS15	$2^{15}-1$

SENSe subsystem - Receiver SDH Settings

PRBS20	$2^{20}-1$
QRSS	$2^{20}-1$ with 14 consecutive zero limit (DS1 only)
PRBS23	$2^{23}-1$
AZERo	All Zero's
AONE	All One's
STRes	3-in-24 stress pattern (DS1 only) (requires option 110)
P1010	Word 1010
P1000	Word 1000
UWORD	16 Bit User Word
LIVE	Live Traffic

Selects the receiver SDH payload data pattern. This selection tracks :SENSe:DATA:TELEcom:SDH:TRIButary:PAYLoad:PATtern <discrete> and :SENSe:DATA:TELEcom:SDH:PRIMary:PAYLoad:PATtern <discrete>. If UWORD is selected, the word pattern is set using :SENSe:DATA:TELEcom:SDH:PAYLoad:UWORD <string>.

The corresponding query returns the receiver SDH payload data pattern in discrete form as listed above.

:SENSe:DATA:TELEcom:SDH:PAYLoad:PATtern?

Returns : <discrete>

:SENSe:DATA:TELEcom:SDH:PAYLoad:UWORD <string>

Sets the receiver user word pattern in the range "0000000000000000" to "1111111111111111".

The corresponding query returns the user word pattern as a string.

:SENSe:DATA:TELEcom:SDH:PAYLoad:UWORD?

Returns : <string>

SENSe subsystem - Receiver SDH Settings

:SENSe:DATA:TELEcom:SDH:PRBS:POLarity <discrete>

<discrete> = NORMal
 INVerted

Selects the PRBS pattern polarity.

The corresponding query returns the PRBS pattern polarity in discrete form as listed above.

:SENSe:DATA:TELEcom:SDH:PRBS:POLarity?

Returns : <discrete>

**:SENSe:DATA:TELEcom:SDH:TRIButary:CONCatenate
<numeric>,<numeric>**

<numeric> = (first parameter)	0	Concatenation Off
	2	TU2-2C
	3	TU2-3C
	4	TU2-4C
	5	TU2-5C
	6	TU2-6C
<numeric> = (second parameter)	1 to 6	TU2-2C selected
	1 to 5	TU2-3C selected
	1 to 4	TU2-4C selected
	1 to 3	TU2-5C selected
	1 to 2	TU2-6C selected

Selects the TU2 concatenation level (first parameter) and starting at the TU (second parameter).

The corresponding query returns the TU2 concatenation and starting TU in numeric form as listed above.

SENSe subsystem - Receiver SDH Settings

:SENSe:DATA:TELEcom:SDH:TRIButary:CONCatenate?

Returns : <numeric>,<numeric>

Old Commands

The following commands are retained for backwards compatibility:

:SENSe:DATA:TELEcom:SDH:TRIButary:PAYLoad:PATtern <discrete>

See :SENSe:DATA:TELEcom:SDH:PAYLoad:PATtern <discrete>

:SENSe:DATA:TELEcom:SDH:TRIButary:PAYLoad:UWORD <string>

See :SENSe:DATA:TELEcom:SDH:PAYLoad:UWORD <string>

:SENSe:DATA:TELEcom:SDH:PRIMary:PAYLoad:PATtern <discrete>

See :SENSe:DATA:TELEcom:SDH:PAYLoad:PATtern <discrete>

:SENSe:DATA:TELEcom:SDH:PRIMary:PAYLoad:UWORD <string>

See :SENSe:DATA:TELEcom:SDH:PAYLoad:UWORD <string>

SENSe subsystem - Receiver SDH Test Function Commands

SENSe subsystem - Receiver SDH Test Function Commands

Lists the commands associated with the RECEIVE TEST FUNCTION display.

:SENSe:DATA:TELEcom:SDH:TFUNction:TYPE <discrete>

<discrete> =	NONE	Off
	OCAPture	Overhead Capture
	DDCC	DCC Drop
	PGRaph	Pointer Graph
	OBERtest	Overhead BER

Selects the active Receiver Test Function.

The corresponding query returns the active Receiver Test Function, in discrete form as listed above.

:SENSe:DATA:TELEcom:SDH:TFUNction:TYPE?

Returns : <discrete>

:SENSe:DATA:TELEcom:SDH:OCAPture <discrete>

<discrete> =	STOP	Terminates a Capture
	START	Starts a Capture

Starts or terminates an Overhead Capture. Is only valid when

:SENSe:DATA:TELEcom:SDH:TFUNction:TYPE <discrete> is set to OCAP.

The corresponding query returns the current state of the Overhead Capture, in discrete form as listed above.

:SENSe:DATA:TELEcom:SDH:OCAPture?

Returns : <discrete>

SENSe subsystem - Receiver SDH Test Function Commands**:SENSe:DATA:TELEcom:SDH:OCAPture:CHANnel <discrete>**

```

<discrete> =  A1A2 | C1/J0 | Z0 | E1 | F1 |      RS Overhead
                D1D3
                H1H2 | K1K2 | D4D12 | S1 |      MS Overhead
                Z1_1|Z1_2 | Z1_3 | Z2_4 | Z2_5 |
                M1 | Z2_5 | Z2_6 | E2
                J1 | C2 | G1 | F2 | H4 | Z3/F3 |   Path Overhead
                Z4/K3 | Z5/N1

```

This command is retained for backwards compatibility only. For new development the command :SENSe:DATA:TELEcom:SDH:OCAPture:OHBYte <discrete> is recommended.

Selects the overhead byte or bytes to be captured. Is only valid when :SENSe:DATA:TELEcom:SDH:TFUNction:TYPE <discrete> is set to OCAP. Z0 is only valid when a rate higher than STM-1 is selected.

The corresponding query returns the overhead byte or bytes currently selected, in discrete form as listed above.

:SENSe:DATA:TELEcom:SDH:OCAPture:CHANnel?

Returns : <discrete>

:SENSe:DATA:TELEcom:SDH:OCAPture:OHBYte <discrete>

```

<discrete> =  A1A2 | C1/J0 | Z0 | E1 | F1 |      Regenerator Overhead
                D1D3
                H1H2 | K1K2 | D4D12 | S1 | Z1    Multiplexer Overhead
                | Z2 | M1 | E2
                J1 | C2 | G1 | F2 | H4 | F3 | K3 |   Path Overhead
                N1

```

Selects the overhead byte or bytes to be captured. Is only valid when :SENSe:DATA:TELEcom:SDH:TFUNction:TYPE <discrete> is set to OCAP. Z0 is only valid when STM-4 is selected.

The corresponding query returns the byte(s) to be captured in discrete form as listed above.

SENSe subsystem - Receiver SDH Test Function Commands

:SENSe:DATA:TELEcom:SDH:OCAPture:OHBYte?

Returns: <discrete>

:SENSe:DATA:TELEcom:SDH:OCAPture:COLumn <numeric>

<numeric> = 1 to 9

Selects the Section overhead column from which to capture. This only applies to Z1 and Z2.

The corresponding query returns the column to be captured in numeric form.

:SENSe:DATA:TELEcom:SDH:OCAPture:COLumn?

<numeric>= 1 to 9

:SENSe:DATA:TELEcom:SDH:OCAPture:CHANnel:SElect <numeric>

<numeric> = 1 to 4

Only valid if a rate higher than STM-1 is selected. Selects STM-1 number for channels that occur in more than one STM-1:

The corresponding query returns the STM-1 number in numeric form.

:SENSe:DATA:TELEcom:SDH:OCAPture:CHANnel:SElect?

Returns: <numeric>

:SENSe:DATA:TELEcom:SDH:OCAPture:TRIGger <discrete>

<discrete> = OFF
ON
ONNot On Not

SDH Command Reference

SENSe subsystem - Receiver SDH Test Function Commands

Selects the Overhead Capture Trigger mode. If OFF is selected, capture begins immediately. If ON is selected, capture begins when the received data matches the pattern defined by :SENSe:DATA:TELEcom:SDH:OCAPture:TRIGger:PATtern <string>. If ONN is selected, capture begins when the received data does not match the pattern defined by :SENSe:DATA:TELEcom:SDH:OCAPture:TRIGger:PATtern <string>.

The corresponding query returns the selected Trigger mode, in discrete form as listed above.

:SENSe:DATA:TELEcom:SDH:OCAPture:TRIGger?

Returns : <discrete>

:SENSe:DATA:TELEcom:SDH:OCAPture:TRIGger:PATtern <string>

Sets the Overhead Capture Trigger Pattern to the hexadecimal value contained in the string. The number of hexadecimal characters in the string is dependent on the overhead byte or bytes selected.

Two hexadecimal characters are required per byte, for example:

E1 - 1 Byte - "00" to "FF"

D4D12 - 9 Bytes - "000000000000000000" to "FFFFFFFFFFFFFFFFFFFF"

Is only valid when :SENSe:DATA:TELEcom:SDH:TFUNction:TYPE <discrete> is set to OCAP and :SENSe:DATA:TELEcom:SDH:OCAPture:TRIGger <discrete> is set to ON or ONN

The corresponding query returns the Trigger Pattern selected, as a string as described above.

:SENSe:DATA:TELEcom:SDH:OCAPture:TRIGger:PATtern?

Returns : <string>

:SENSe:DATA:TELEcom:SDH:DDCC <discrete>

<discrete> =	RDCC	Regenerator Section DCC
	MDCC	Multiplexer Section DCC

Selects the DataCommunications channel to be dropped via the rear panel DROP port. Is only valid when :SENSe:DATA:TELEcom:SDH:TFUNction:TYPE <discrete> is set to DDCC.

The corresponding query returns the selected DCC, in discrete form as listed above.

SENSe subsystem - Receiver SDH Test Function Commands

:SENSe:DATA:TELEcom:SDH:DDCC?

Returns : <discrete>

:SENSe:DATA:TELEcom:SDH:DDCC:POLarity <discrete>

<discrete> = REVersed
NORMAl

Selects the DCC DROP byte polarity. Is only valid when
:SENSe:DATA:TELEcom:SDH:TFUNction:TYPE <discrete> is set to DDCC.

NOTE

This will also change the TX DCC insert port polarity

The corresponding query returns the DCC polarity in discrete form as listed above.

:SENSe:DATA:TELEcom:SDH:DDCC:POLarity?

Returns <discrete>

:SENSe:DATA:TELEcom:SDH:PGRaph:PTYPE <discrete>

<discrete> = AU4-4C
AU4
AU3
TU3
TU2
TU12
TU11

Selects the type of pointer to be captured for pointer graph.

The corresponding query returns the type of pointer, in discrete short form.

:SENSe:DATA:TELEcom:SDH:PGRaph:PTYPE?

Returns: <discrete>

SENSe subsystem - Receiver SDH Test Function Commands**:SENSe:DATA:TELEcom:SDH:PGRaph:CINterval <discrete>**

<discrete> =	SEC1	1 second interval
	SEC5	5 second interval
	SEC20	20 second interval
	MIN1	1 minute interval
	MIN5	5 minute interval
	MIN20	20 minute interval

Selects the pointer graph capture interval.

The corresponding query returns the pointer graph capture interval, in discrete form as listed above.

:SENSe:DATA:TELEcom:SDH:PGRaph:CINterval?

Returns: <discrete>

:SENSe:DATA:TELEcom:SDH:OBERtest:CHANnel <discrete>

<discrete> =	C1/J0 Z0 E1 F1 D1 D2	RS Overhead D3
	K1 K2 D4 D5 D6 D7 D8	MS Overhead D9 D10 D11 D12 S1/Z1 M1/Z2 E2
	J1 C2 G1 F2 H4 Z3/F3	Path Overhead Z4/K3 Z5/N1

Selects the overhead byte used for the overhead BER test. Is only valid when :SENSe:DATA:TELEcom:SDH:TFUNction:TYPE <discrete> is set to OBER . Z0 is only valid when a rate above STM-1 is selected.

The corresponding query returns the Overhead byte name in discrete form as listed above.

:SENSe:DATA:TELEcom:SDH:OBERtest:CHANnel?

Returns <discrete>

:SENSe:DATA:TELEcom:SDH:OBERtest:COLumn <numeric>

SENSe subsystem - Receiver SDH Test Function Commands

<numeric>= 1 to 3 1,4,7; 2,5,8 or 3,6,9

Sets the column in the Section overhead of the channel for the receiver overhead BER test function. This command is only valid if

:SENSe:DATA:TELEcom:SDH:TFUNction:TYPE <discrete> is set to OBER.

The corresponding query returns the column in numeric form as listed above

SENSe:DATA:TELEcom:SDH:OBERtest:COLumn?

Returns: <numeric>

:SENSe:DATA:TELEcom:SDH:OBERtest:CHANnel:SElect <numeric>

<numeric> =	1	Valid for all bytes
	2	Valid for Z0
	3	Valid for Z0, M1
	4	Valid for Z0

Only valid if a rate higher than STM-1 is selected. Selects STM-1 number for channels that occur in more than one STM-1:

The corresponding query returns the STM-1 number in numeric form.

:SENSe:DATA:TELEcom:SDH:OBERtest:CHANnel:SElect?

Returns: <numeric>

SENSe subsystem - Alarm Scan Control

:SENSe:DATA:TELEcom:SDH:ASCan:MODE <discrete>

<discrete> = AUTomatic Automatic receiver configuration
 RSETtings Fixed receiver configuration

Option A1T, A3R only. Selects the SDH alarm scan mode.

The corresponding query returns the alarm scan mode in discrete short form.

:SENSe:DATA:TELEcom:SDH:ASCan:MODE?

Returns: <discrete>

:SENSe:DATA:TELEcom:SDH:ASCan:BIP <discrete>

<discrete> = OFF Fail if Alarm
 GTE0 Fail if alarm or any BIP error
 GTEE_6 Fail if alarm or BIP ER > 10E-6
 GTEE_3 Fail if alarm or BIP ER > 10E-3

Option A1T, A3R only. Selects the SDH alarm scan BIP error threshold.

The corresponding query returns the alarm scan BIP error threshold in discrete short form.

:SENSe:DATA:TELEcom:SDH:ASCan:BIP?

Returns: <discrete>

:SENSe:DATA:TELEcom:SDH:ASCan <boolean>

<boolean> = 0 or OFF Stop the current alarm scan
 1 or ON Start a new alarm scan

Option A1T, A3R only. Start/Stop the SDH alarm scan.

The corresponding query returns the alarm scan state as 0 or 1.

SDH Command Reference

SENSe subsystem - Alarm Scan Control

:SENSe:DATA:TELEcom:SDH:ASCan?

Returns: <boolean>

SENSe subsystem - SDH Tributary Scan Control

SENSe subsystem - SDH Tributary Scan Control**:SENSe:DATA:TELEcom:SDH:TSCan:PERiod <numeric>,<suffix>**

<numeric> =	1 to 99	
<suffix> =	d	Days
	h	Hours
	m	Minutes
	s	Seconds

Sets the test duration for each tributary.

The corresponding query returns the test duration for each tributary.

:SENSe:DATA:TELEcomSDH:TSCan:PERiod?

Returns: <numeric>,<suffix>

:SENSe:DATA:TELEcom:SDH:TSCan:BIP <discrete>

<discrete> =	GTE0	Fail if any BIP error
	GTEE_6	Fail if BIP ER > 10E-6
	GTEE_3	Fail if BIP ER > 10E-3

Option A1T, A3R only. Selects the SDH tributary scan BIP error threshold.

The corresponding query returns the alarm scan BIP error threshold in discrete short form.

:SENSe:DATA:TELEcom:SDH:TSCan:BIP?

Returns: <discrete>

:SENSe:DATA:TELEcom:SDH:TSCan <boolean>

<boolean> =	0 or OFF	Stop the current tributary scan
	1 or ON	Start a new tributary scan

Option A1T, A3R only. Start/Stop the SDH tributary scan.

SDH Command Reference

SENSe subsystem - SDH Tributary Scan Control

The corresponding query returns the alarm scan state as 0 or 1.

:SENSe:DATA:TELEcom:SDH:TSCan?

Returns: <boolean>

SENSe subsystem - Optical Power Measurement Settings

SENSe subsystem - Optical Power Measurement Settings

:SENSe:DATA:TELEcom:SDH:WAVelength <discrete>

<discrete> =	NM1310	1310 nm
	NM1550	1550 nm

Selects the wavelength of the input optical signal on the Optical module Option USN only, for use as part of the optical power measurement calculation.

The corresponding query returns the input optical wavelength in discrete form, as listed above.

:SENSe:DATA:TELEcom:SDH:WAVelength?

Returns : <discrete>

SENSe subsystem - Result Returning Commands

Frequency Results (SDH)

:SENSe:DATA? <"result">

Result =	"FREQuency:SDH"	RX SDH clock frequency
	"FOFPpm:SDH"	RX SDH clock offset in ppm
	"FOFHz:SDH"	RX SDH clock offset in Hz

SDH Short Term Results

:SENSe:DATA? <"result">

Result =	"ECOunt:SDH:STERm:FRAME"	Frame error count (A1T/A3R Only)
	"ERATio:SDH:STERm:FRAME"	Frame error ratio (A1T/A3R only)
	"ECOunt:SDH:STERm:RSBip"	RS B1 BIP error count
	"ERATio:SDH:STERm:RSBip"	RS B1 BIP error ratio
	"ECOunt:SDH:STERm:MSBip"	MS B2 BIP error count
	"ERATio:SDH:STERm:MSBip"	MS B2 BIP error ratio
	"ECOunt:SDH:STERm:MFEBe" or "ECOunt:SDH:STERm:MSRei"	MS FEBE/MS REI error count (A1T/ A3R Only)
	"ERATio:SDH:STERm:MFEBe" or "ERATio:SDH:STERm:MSRei"	MS FEBE/MS REI error ratio (A1T/ A3R Only)
	"ECOunt:SDH:STERm:PBIP"	Path B3 BIP error count
	"ERATio:SDH:STERm:PBIP"	Path B3 BIP error ratio
	"ECOunt:SDH:STERm:FEBe" or "ECOunt:SDH:STERm:REI"	FEBE/REI error count
	"ERATio:SDH:STERm:FEBe" or "ERATio:SDH:STERmREI"	FEBE/REI error ratio

SENSe subsystem - Result Returning Commands

"ECOUNT:SDH:STERm:PIEC"	PIEC error count (A1T/A3R Only)
"ERATio:SDH:STERm:PIEC"	PIEC error ratio (A1T/A3R Only)
"ECOUNT:SDH:STERm:TRIB:PBIP"	TU path BIP error count
"ERATio:SDH:STERm:TRIB:PBIP"	TU path BIP error ratio
"ECOUNT:SDH:STERm:TRIB:FEBE" or "ECOUNT:SDH:STERm:TRIB:REI"	TU FEBE/LP REI error count
"ERATio:SDH:STERm:TRIB:FEBE" or "ERATio:SDH:STERm:TRIB:REI"	TU FEBE/LP REI error ratio

SDH Cumulative Results

:SENSe:DATA? <"result">

Result = "ECOUNT:SDH:FRAMe"	Frame error count (A1T/A3R Only)
"ERATio:SDH:FRAMe"	Frame error ratio (A1T/A3R only)
"ECOUNT:SDH:RSBip"	RS B1 BIP error count
"ERATio:SDH:RSBip"	RS B1 BIP error ratio
"ECOUNT:SDH:MSBip"	MS B2 BIP error count
"ERATio:SDH:MSBip"	MS B2 BIP error ratio
"ECOUNT:SDH:MFEBe" or "ECOUNT:SDH:"MSRei"	MS FEBE/MS REI error count (A1T/ A3R Only)
"ERATio:SDH:MFEBe" or "ERATio:SDH:MSRei"	MS FEBE/MS REI error ratio (A1T/ A3R Only)
"ECOUNT:SDH:PBIP"	Path B3 BIP error count
"ERATio:SDH:PBIP"	Path B3 BIP error ratio
"ECOUNT:SDH:FEBE" or "ECOUNT:SDH:REI"	FEBE/REI error count
"ERATio:SDH:FEBE" or "ERATio:SDH:REI"	FEBE/REI error ratio
"ECOUNT:SDH:PIEC"	PIEC error count (A1T/A3R Only)
"ERATio:SDH:PIEC"	PIEC error ratio (A1T/A3R Only)

SDH Command Reference

SENSe subsystem - Result Returning Commands

"ECOut:SDH:TRIB:PBIP"	TU path BIP error count
"ERATio:SDH:TRIB:PBIP"	TU path BIP error ratio
"ECOut:SDH:TRIB:FEBE" or "ECOut:SDH:TRIB:REI"	TU FEBE/LP REI error count
"ERATio:SDH:TRIB:FEBE" or "ERATio:SDH:TRIB:REI"	TU FEBE/LP REI error ratio
"ECOut:SDH:OVERhead"	Overhead error count (A1T/A3R Only)

SDH RS B1 BIP Analysis Results

:SENSe:DATA? <"result">

Result=	"ESECONDS:SDH:RSBip:ANALYSIS"	Error Seconds
	"SESECONDS:SDH:RSBip:ANALYSIS"	Severely Errored Seconds
	"EBCOUNT:SDH:RSBip:ANALYSIS"	Errored block count
	"BBECOUNT:SDH:RSBip:ANALYSIS"	Background block error count
	"ESRATIO:SDH:RSBip:ANALYSIS"	Error Second Ratio
	"SESRATIO:SDH:RSBip:ANALYSIS"	Severely Errored Second Ratio
	"BBERATIO:SDH:RSBip:ANALYSIS"	Background Block Error ratio
	"UASECONDS:SDH:RSBip:ANALYSIS"	Unavailable seconds

SDH MS B2 BIP Analysis Results

:SENSe:DATA? <"result">

Result=	"ESECONDS:SDH:MSBip:ANALYSIS"	Error Seconds
	"SESECONDS:SDH:MSBip:ANALYSIS"	Severely Errored Seconds
	"EBCOUNT:SDH:MSBip:ANALYSIS"	Errored block count
	"BBECOUNT:SDH:MSBip:ANALYSIS"	Background block error count
	"ESRATIO:SDH:MSBip:ANALYSIS"	Error Second Ratio
	"SESRATIO:SDH:MSBip:ANALYSIS"	Severely Errored Second Ratio

SDH Command Reference

SENSe subsystem - Result Returning Commands

"BBERatio:SDH:MSBip:ANALysis"	Background Block Error ratio
"UASeconds:SDH:MSBip:ANALysis"	Unavailable seconds
"PUASeconds:SDH:MSBip:ANALysis"	Path Unavailable seconds (A1T/A3R only)

SDH Path MS FEBE Analysis Results

:SENSe:DATA? <"result">

Result=	"ESECONDS:SDH:MFEBe:ANALysis" or "ESECONDS:SDH:MSRei:ANALysis"	Error Seconds
	"SESeconds:SDH:MFEBe:ANALysis" or "SESeconds:SDH:MSRei:ANALysis"	Severely Errored Seconds
	"EBCount:SDH:MFEBe:ANALysis" or "EBCount:SDH:MSRei:ANALysis"	Errored block count
	"BBECount:SDH:MFEBe:ANALysis" or "BBECount:SDH:MSRei:ANALysis"	Background block error count
	"ESRatio:SDH:MFEBe:ANALysis" or "ESRatio:SDH:MSRei:ANALysis"	Error Second Ratio
	"SESRatio:SDH:MFEBe:ANALysis" or "SESRatio:SDH:MSRei:ANALysis"	Severely Errored Second Ratio
	"BBERatio:SDH:MFEBe:ANALysis" or "BBERatio:SDH:MSREI:ANALysis"	Background Block Error ratio
	"UASeconds:SDH:MFEBe:ANALysis" or "UASeconds:SDH:MSRei:ANALysis"	Unavailable seconds
	"PUASeconds:SDH:MFEBe:ANALysis" or "PUASeconds:SDH:MSRei:ANALysis"	Path Unavailable seconds

SDH Command Reference
SENSe subsystem - Result Returning Commands

SDH Path B3 BIP Analysis Results

:SENSe:DATA? <"result">

Result=	"ESECONDS:SDH:PBIP:ANALYSIS"	Error Seconds
	"SECONDS:SDH:PBIP:ANALYSIS"	Severely Errored Seconds
	"EBCOUNT:SDH:PBIP:ANALYSIS"	Errored block count
	"BBECOUNT:SDH:PBIP:ANALYSIS"	Background block error count
	"ESRATIO:SDH:PBIP:ANALYSIS"	Error Second Ratio
	"SESRATIO:SDH:PBIP:ANALYSIS"	Severely Errored Second Ratio
	"BBERATIO:SDH:PBIP:ANALYSIS"	Background Block Error ratio
	"UASECONDS:SDH:PBIP:ANALYSIS"	Unavailable seconds
	"PUASECONDS:SDH:PBIP:ANALYSIS"	Path Unavailable seconds

SDH Path FEBE Analysis Results

:SENSe:DATA? <"result">

Result=	"ESECONDS:SDH:FEBE:ANALYSIS" or "ESECONDS:SDH:REI:ANALYSIS"	Error Seconds
	"SECONDS:SDH:FEBE:ANALYSIS" or "SECONDS:SDH:REI:ANALYSIS"	Severely Errored Seconds
	"EBCOUNT:SDH:FEBE:ANALYSIS" or "EBCOUNT:SDH:REI:ANALYSIS"	Errored block count
	"BBECOUNT:SDH:FEBE:ANALYSIS" or "BBECOUNT:SDH:REI:ANALYSIS"	Background block error count
	"ESRATIO:SDH:FEBE:ANALYSIS" or "ESRATIO:SDH:REI:ANALYSIS"	Error Second Ratio
	"SESRATIO:SDH:FEBE:ANALYSIS" or "SESRATIO:SDH:REI:ANALYSIS"	Severely Errored Second Ratio
	"BBERATIO:SDH:FEBE:ANALYSIS" or "BBERATIO:SDH:REI:ANALYSIS"	Background Block Error ratio

SENSe subsystem - Result Returning Commands

"UASeconds:SDH:FEBE:ANALysis" or "UASeconds:SDH:REI:ANALysis"	Unavailable seconds
"PUASeconds:SDH:FEBE:ANALysis" or "PUASeconds:SDH:REI:ANALysis"	Path Unavailable seconds

SDH Path IEC Analysis Results

:SENSe:DATA? <"result">

Result= "ESEconds:SDH:PIEC:ANALysis"	Error Seconds
"SESeconds:SDH:PIEC:ANALysis"	Severely Errored Seconds
"EBCount:SDH:PIEC:ANALysis"	Errored block count
"BBECount:SDH:PIEC:ANALysis"	Background block error count
"ESRatio:SDH:PIEC:ANALysis"	Error Second Ratio
"SESRatio:SDH:PIEC:ANALysis"	Severely Errored Second Ratio
"BBERatio:SDH:PIEC:ANALysis"	Background Block Error ratio
"UASeconds:SDH:PIEC:ANALysis"	Unavailable seconds

SDH Tributary Path BIP Analysis Results

:SENSe:DATA? <"result">

Result= "ESEconds:SDH:TRIB:PBIP:ANALysis"	Error Seconds
"SESeconds:SDH:TRIB:PBIP:ANALysis"	Severely Errored Seconds
"EBCount:SDH:TRIB:PBIP:ANALysis"	Errored block count
"BBECount:SDH:TRIB:PBIP:ANALysis"	Background block error count
"ESRatio:SDH:TRIB:PBIP:ANALysis"	Error Second Ratio
"SESRatio:SDH:TRIB:PBIP:ANALysis"	Severely Errored Second Ratio
"BBERatio:SDH:TRIB:PBIP:ANALysis"	Background Block Error ratio
"UASeconds:SDH:TRIB:PBIP:ANALysis"	Unavailable seconds
"PUASeconds:SDH:TRIB:PBIP:ANALysis"	Path Unavailable seconds

SDH Command Reference
SENSe subsystem - Result Returning Commands

SDH Tributary Path FEBE Analysis Results

:SENSe:DATA? <"result">

Result =	"ESECONDS:SDH:TRIB:FEBE:ANALYSIS" or "ESECONDS:SDH:TRIB:REI:ANALYSIS"	Error Seconds
	"SECONDS:SDH:TRIB:FEBE:ANALYSIS" or "SECONDS:SDH:TRIB:REI:ANALYSIS"	Severely Errored Seconds
	"EBCOUNT:SDH:TRIB:FEBE:ANALYSIS" or "EBCOUNT:SDH:TRIB:REI:ANALYSIS"	Errored block count
	"BBECOUNT:SDH:TRIB:FEBE:ANALYSIS" or "BBECOUNT:SDH:TRIB:REI:ANALYSIS"	Background block error count
	"ESRATIO:SDH:TRIB:FEBE:ANALYSIS" or "ESRATIO:SDH:TRIB:REI:ANALYSIS"	Error Second Ratio
	"SESRATIO:SDH:TRIB:FEBE:ANALYSIS" or "SESRATIO:SDH:TRIB:REI:ANALYSIS"	Severely Errored Second Ratio
	"BBERATIO:SDH:TRIB:FEBE:ANALYSIS" or "SESRATIO:SDH:TRIB:REI:ANALYSIS"	Background Block Error ratio
	"UASECONDS:SDH:TRIB:FEBE:ANALYSIS" or "UASECONDS:SDH:TRIB:REI:ANALYSIS"	Unavailable seconds
	"PUASECONDS:SDH:TRIB:FEBE:ANALYSIS" or "PUASECONDS:SDH:TRIB:REI:ANALYSIS"	Path Unavailable seconds

SDH Block Based Bit Analysis Results

:SENSe:DATA? <"result">

Result =	"ESECONDS:SDH:BLKBIT:ANALYSIS"	Error Seconds
	"SECONDS:SDH:BLKBIT:ANALYSIS"	Severely Errored Seconds
	"EBCOUNT:SDH:BLKBIT:ANALYSIS"	Errored block count
	"BBECOUNT:SDH:BLKBIT:ANALYSIS"	Background block error count
	"ESRATIO:SDH:BLKBIT:ANALYSIS"	Error Second Ratio

SENSe subsystem - Result Returning Commands

"SESRatio:SDH:BLKBit:ANALysis"	Severely Errored Second Ratio
"BBERatio:SDH:BLKBit:ANALysis"	Background Block Error ratio
"UASeconds:SDH:BLKBit:ANALysis"	Unavailable seconds

SDH M.2101 Analysis Results

:SENSe:DATA? <“result”>

Result = "ESECONDS:SDH:LOW:RECEIVE:ANALYSIS:M2101"	Low Order Path Receive Direction Errored Seconds
"SECONDS:SDH:LOW:RECEIVE:ANALYSIS:M2101"	Low Order Path Receive Direction Severely Errored Seconds
"UASeconds:SDH:LOW:RECEIVE:ANALYSIS:M2101"	Low Order Path Receive Direction Unavailable Seconds
"ESECONDS:SDH:LOW:TRANSMIT:ANALYSIS:M2101"	Low Order Path Transmit Direction Errored Seconds
"SECONDS:SDH:LOW:TRANSMIT:ANALYSIS:M2101"	Low Order Path Transmit Direction Severely Errored Seconds
"UASeconds:SDH:LOW:TRANSMIT:ANALYSIS:M2101"	Low Order Path Transmit Direction Unavailable Seconds
"ESECONDS:SDH:HIGH:RECEIVE:ANALYSIS:M2101"	High Order Path Receive Direction Errored Seconds
"SECONDS:SDH:HIGH:RECEIVE:ANALYSIS:M2101"	High Order Path Receive Direction Severely Errored Seconds
"UASeconds:SDH:HIGH:RECEIVE:ANALYSIS:M2101"	High Order Path Receive Direction Unavailable Seconds
"ESECONDS:SDH:HIGH:TRANSMIT:ANALYSIS:M2101"	High Order Path Transmit Direction Errored Seconds
"SECONDS:SDH:HIGH:TRANSMIT:ANALYSIS:M2101"	High Order Path Transmit Direction Severely Errored Seconds
"UASeconds:SDH:HIGH:TRANSMIT:ANALYSIS:M2101"	High Order Path Transmit Direction Unavailable Seconds

SENSe subsystem - Result Returning Commands

"ESECONDS:SDH:SECTION:RECEIVE:ANALYSIS:M2101"	Section Layer Path Receive Direction Errored Seconds
"SECONDS:SDH:SECTION:RECEIVE:ANALYSIS:M2101"	Section Layer Path Receive Direction Severely Errored Seconds
"UASECONDS:SDH:SECTION:RECEIVE:ANALYSIS:M2101"	Section Layer Path Receive Direction Unavailable Seconds
"ESECONDS:SDH:SECTION:TRANSMIT:ANALYSIS:M2101"	Section Layer Path Transmit Direction Errored Seconds
"SECONDS:SDH:SECTION:TRANSMIT:ANALYSIS:M2101"	Section Layer Path Transmit Direction Severely Errored Seconds
"UASECONDS:SDH:SECTION:TRANSMIT:ANALYSIS:M2101"	Section Layer Path Transmit Direction Unavailable Seconds

SDH Service Disruption Results

:SENSe:DATA? <"result">

Result = "SDTest:COUNt:LONG"	Longest error burst
SDTest:COUNt:SHORT"	Shortest error burst
"SDTest:COUNt:LAST"	Last error burst

Returns: <range>,<value>

<range> =	0	Result invalid due to receiver configuration
	1	Result valid
	2	Result out of range

Value is returned in milliseconds. If the value is > 2000 or no result is available or the result is not applicable then 9.91E+37 is returned.

SDH Command Reference
SENSe subsystem - Result Returning Commands

SDH Optical Power Result

:SENSe:DATA? <"result">

Result = "OPOWer:SDH" Optical power (dBm)

SDH Pointer Activity Results

:SENSe:DATA? <"result">

Result = "PACTivity:SDH:PVALue"	AU Pointer value
"PACTivity:SDH:NDFSeconds"	AU Pointer NDF seconds
"PACTivity:SDH:MNDFseconds"	AU Pointer MNDF seconds
"PACTivity:SDH:PCOunt"	AU Pointer +ve Adj Count
"PACTivity:SDH:PSEConds"	AU Pointer +ve Adj Seconds
"PACTivity:SDH:NCOunt"	AU Pointer -ve Adj Count
"PACTivity:SDH:NSEConds"	AU Pointer -ve Adj Seconds
"PACTivity:SDH:IOFFset"	Implied VC4 Offset
"PACTivity:SDH:TRIButary:PVALue"	TU Pointer Value
"PACTivity:SDH:TRIButary:NDFSeconds"	TU Pointer NDF seconds
"PACTivity:SDH:TRIButary:MNDFseconds"	TU Pointer MNDF seconds
"PACTivity:SDH:TRIButary:PCOunt"	TU Pointer +ve Adj Count
"PACTivity:SDH:TRIButary:PSEConds"	TU Pointer +ve Adj Seconds
"PACTivity:SDH:TRIButary:NCOunt"	TU Pointer -ve Adj Count
"PACTivity:SDH:TRIButary:NSEConds"	TU Pointer -ve Adj Seconds
"PACTivity:SDH:TRIButary:IOFFset"	Implied TU VC Offset

SENSe subsystem - Result Returning Commands**SDH Alarm Seconds Results**

:SENSe:DATA? <"result">

Result =	"ASEConds:PLOSs"	Power loss
	"ASEConds:SDH:LOS"	Loss Of Signal
	"ASEConds:SDH:LOF"	Loss Of Frame
	"ASEConds:SDH:OOF"	Out Of Frame
	"ASEConds:SDH:H4MF"	H4 Multiframe Loss
	"ASEConds:SDH:LOP"	Loss Of Pointer
	"ASEConds:SDH:MSAis"	Multiplexer Section AIS
	"ASEConds:SDH:PAIS"	Path AIS
	"ASEConds:SDH:PSLoss"	Pattern Synchronization Loss
	"ASEConds:SDH:MSFerf"	Multiplexer Section FERF
	"ASEConds:SDH:PFERf" or "ASEConds:SDH:RDI"	STM Path FERF/HP-RDI
	"ASEConds:SDH:K1K2"	K1K2 byte change (A1T/A3R Only)
	"ASEConds:SDH:TRIB:LOP"	TU Loss Of Pointer
	"ASEConds:SDH:TRIB:PAIS"	TU Path AIS
	"ASEConds:SDH:TRIB:PFERf"	TU Path FERF/LP-RDI
	or "ASEConds:SDH:TRIB:RDI"	
	"ASEConds:SDH:OPSL"	Overhead Pattern Sync Loss

FETCh subsystem

FETCh subsystem

The FETCh subsystem is used to retrieve data directly accumulated by the instrument.

:FETCh:STRing:DATA:TELEcom:SDH:J0?

Returns: <string>

The value of the STM-N regenerator overhead J0 byte is returned as a 16 ASCII character string if CRC7 is not detected, 15 ASCII character string if CRC7 is detected. If the string contains any non printing characters then ~ is substituted. This is a snapshot of the overhead byte and is captured once per second.

:FETCh:STRing:DATA:TELEcom:SDH:J0:HEXadecimal?

Returns: <block>

Returns the value of the STM-N regenerator overhead J0 byte as 16 hexadecimal numbers if CRC7 is not detected, 15 hexadecimal numbers if CRC7 is detected. Each number is in the range "00" to "FF". The block header is "#216" if CRC7 not detected, "#215" if CRC7 is detected. This is a snapshot of the overhead byte and is captured once per second.

:FETCh:STRing:DATA:TELEcom:SDH:J1?

Returns : <string>

If interfacing at STM-1/4, the value of the VC-4 J1 path trace byte is returned as a, 64 ASCII character, string (15 ASCII characters if CRC7 is detected). If interfacing at STM-0, the value of the VC-3 J1 path trace byte is returned as a string. If the string contains any non printing characters then ~ is substituted. This is a snapshot of the overhead byte and is captured once per second.

:FETCh:STRing:DATA:TELEcom:SDH:J1:HEXadecimal?

Returns : <block>

SDH Command Reference

FETCh subsystem

If interfacing at STM-1/4, returns the value of the VC-4 J1 path trace byte as 64 hexadecimal numbers (15 if CRC7 is detected). If interfacing at STM-0, the value of the VC-3 J1 path trace byte is returned as 64 hexadecimal numbers (15 if CRC7 is detected).

Each number is in the range "00" to "FF". The block header is "#264" (" #215" if CRC7 is detected). This is a snapshot of the overhead byte and is captured once per second.

:FETCh:STRing:DATA:TELEcom:SDH:TRIButary:J1?

Returns : <string>

When the VC-3 is mapped into a higher level container such as VC-4 the value of the VC-3 J1 path trace byte is returned as a, 64 ASCII character, string (15 ASCII characters if CRC7 is detected). If the string contains any non printing characters then ~ is substituted. This is a snapshot of the overhead byte and is captured once per second.

:FETCh:STRing:DATA:TELEcom:SDH:TRIButary:J1:HEXadecimal?

Returns : <block>

When the VC-3 is mapped into a higher level container such as VC-4 returns the value of the VC-3 J1 path trace byte as 64 hexadecimal numbers (15 if CRC7 is detected). Each number is in the range "00" to "FF". The block header is "#264" (" #215" if CRC7 is detected). This is a snapshot of the overhead byte and is captured once per second.

:FETCh:STRing:DATA:TELEcom:SDH:TRIButary:J2?

Returns: <string>

Returns the 15 or 16 byte J2 path trace as a string. The HP 37717C attempts to align the received pattern by detecting the CRC7 byte. If the CRC7 byte is detected, a 15 byte pattern is returned. If the CRC7 byte is not detected, a 16 byte pattern is returned. If the string contains any non-printing characters then ~ is substituted. This is a snapshot of the received path trace and is only updated once per second.

:FETCh:STRing:DATA:TELEcom:SDH:TRIButary:J2:HEXadecimal?

Returns: <block>

SDH Command Reference

FETCh subsystem

Returns the value of the J2 path trace byte as 15 or 16 hexadecimal numbers. The HP 37717C attempts to align the received pattern by detecting the CRC7 byte. If the CRC7 byte is detected, 15 hexadecimal numbers are returned. If the CRC7 byte is not detected, 16 hexadecimal numbers are returned. Each number is in the range "00" to "FF". The block header is "#215" if 15 Hex numbers and "#216" if 16 Hex numbers. This is a snapshot of the overhead byte and is captured once per second.

:FETCh:STRing:DATA:TELEcom:SDH:K1?

Returns : <string>

The value of the MPS K1 byte is returned as an 8 bit string in the range "00000000" to "11111111".

:FETCh:STRing:DATA:TELEcom:SDH:K2?

Returns : <string>

The value of the MPS K2 byte is returned as an 8 bit string in the range "00000000" to "11111111".

:FETCh:STRing:DATA:TELEcom:SDH:S1?

Returns : <string>

The value of the SYNC S1 byte (bits 5-8) is returned as a 4 bit string in the range "0000" to "1111".

:FETCh:SCALar:DATA:TELEcom:SDH:OVERhead? <numeric>,<numeric>,<discrete>

<numeric> = range 1 to 4
(first parameter)

<numeric> = range 1 to 3
(second parameter)

<discrete> = A1|A2|C1|J0|B1|E1|F1|D1|D2|D3|H1|H2
H3|K1|K2|D4|D5|D6|D7|D8|D9|D10|D11
D12|S1|Z2|M1|E2|X13|X21|X22|X23|X31
X32|X33|X52|X53|X61|X62|X63

FETCh subsystem

X71|X72|X73|X81|X82|X83|X93

Returns the selected overhead byte as an 8 bit binary string in the range "00000000" to "11111111". The byte number is given by its defined name if it has one.

Undefined bytes are represented by <Xrc>, where r is the numerical value of the bytes row in the transport overhead and c is the numerical value of the bytes column in the transport overhead.

If an STM-1 signal is being transmitted, the only applicable value of VC4 is 1.

Notice that column number 1 is actually columns 1,4 & 7, 2 is columns 2,5 & 8 and 3 is columns 3,6 & 9.

C1/J0 byte: If option A1T/A3R is fitted, the J0 capability is available at STM-0 and STM-1 only. Z2/M1 byte:

M1 is only available if Option A1T/A3R is fitted. If any other SDH option is fitted, the Z2 capability is available and M1 is not available.

Z0 byte is only available if Option 130/131 is fitted and STM-4 is selected.

Returns: <string>

:FETCh:SCALAr:DATA:TELEcom:SDH:POVerhead:H4Sequence?

Obtains the length of the H4 byte sequence.

Returns :	<discrete>	LONG	Long sequence
		SHOR	Short sequence
		UNKN	Unknown sequence

:FETCh:SCALAr:DATA:TELEcom:SDH:POVerhead? <discrete>

<discrete> = J|B3|C2|G1|F2|H4|Z3|F3|Z4/
K3|Z5/N1

Obtains the value of the named path overhead byte. The value of the named byte is returned as a string in the range "00000000" to "11111111". This is a snapshot of the overhead byte and is captured once per second.

Returns: <string>

:FETCh:SCALAr:DATA:TELEcom:SDH:TRIButary:POVerhead? <discrete>

<discrete> =	C2 G1 F2 H4 Z3 F3 Z4 K3 Z5 N1	TU-3
	V5 N2 K4 J2	TU-2/TU-12/TU11

SDH Command Reference

FETCh subsystem

Obtains the value of the specified path overhead byte. The value of the named byte is returned as a string in the range "00000000" to "11111111". This is a snapshot of the overhead byte and is captured once per second.

Returns: <string>

:FETCh:SCALar:DATA:TELEcom:SDH:TRIButary:POVerhead:SLABel?

Returns the signalling label of the selected tributary in numeric form.

Returns: <numeric>

:FETCh:ARRAy:DATA:TELEcom:SDH:ASCan?

Returns (each of one or more rows): <numeric>{,<numeric>}

The results returned are those for the last FULL scan. Results from partial scans are not available. If no full scan has been completed since the instrument was powered up, this command will return -1.

If data is available it is returned as a set of string arrays one for each scanned group. The arrays are separated by a CR/LF pair. A group is defined as a set of scanned paths at either the AU or TU level. The arrays consist of comma separated numerics, one for each path scanned. The value of the numeric indicates the status of the scanned path. The following values are valid.

Value	State
0	No Problems Detected
1	Alarms or Errors Detected
2	Path Unequipped
3	Loss of Pointer
4	AIS
5	RDI
6	H4 Multiframe Loss
?	Invalid

FETCh subsystem

For a specific signal structure, the format of the returned strings are shown below:

a) STM-1 AU-4 TU-2

This signal consists of 1 AU-4 containing 3 TUG-3's each of which contains 7 TUG-2s. The TUG-2's in turn each contain a TU-2. From the perspective of the Alarm Scan function the paths are 1 at the AU-4 level and 21 at the TU level. The single AU path is defined as a group on its own while the 21 TUs are arranged as 3 groups of 7 paths with the groups corresponding to the TUG-2 allocation. For this configuration, four arrays are returned with formats shown below:

```
AU-4 GROUP -> AU4
TUG-3 #1    -> TU#1 , TU#2 , TU#3 , TU#4 , TU#5 , TU#6 , TU#7
TUG-3 #2    -> TU#1 , TU#2 , TU#3 , TU#4 , TU#5 , TU#6 , TU#7
TUG-3 #3    -> TU#1 , TU#2 , TU#3 , TU#4 , TU#5 , TU#6 , TU#7
```

For Example, the output could look like:

```
0
1, 1, 1, 0, 0, 1, 0
2, 2, 2, 2, 2, 2, 2
0, 0, 0, 0, 1, 0, 0
```

b) STM-1 AU-4 TU-3

This signal consists of 1 AU-4 containing 3 TUG-3's each of which contains 1 TU-3. In this configuration there are 4 paths, 1 at the AU-4 level and 3 at the TU-3 level. Again, the single AU path is defined as a group on its own. The TU paths in this instance are also defined as groups corresponding to their allocation within the TUG-3's. For this configuration, four arrays are returned with the following format:

```
AU-4 Group -> AU-4
TUG-3 #1    -> TU-3 #1
TUG-3 #2    -> TU-3 #2
TUG-3 #3    -> TU-3 #3
```

The output will look something like:

```
0
1
2
2
```

SDH Command Reference

FETCh subsystem

The output will look something like:

```
0,1,2
```

g) STM-1 AU-3 TU-12

This signal again consists of 3 AU-3's. In this case however, the AU-3's each contain 7 TUG-2's. These TUG-2's each contain 3 TU-12's. In terms of paths the signal comprises 3 paths at the AU-3 level and 63 paths at the TU-12 level. Again the AU-3s are defined as a group on their own. The 63 TU-12 paths are split into 3 groups corresponding to their allocation with the 3 AU-3's. For this configuration, four arrays are returned with the following format:

NOTE: TU-12's designated thus [AU-3# - TUG-2# - TU#]

```
AUG -> AU-3#1, AU-3#2, AU-3#3
```

```
AU-3 #1 -> [1-1-1],[1-1-2],[1-1-3],[1-2-1],[1-2-2],[1-2-3],  
           [1-3-1],[1-3-2],[1-3-3],[1-4-1],[1-4-2],[1-4-3],  
           [1-5-1],[1-5-2],[1-5-3],[1-6-1],[1-6-2],[1-6-3],  
           [1-7-1],[1-7-2],[1-7-3]
```

```
AU-3 #2 -> As Above
```

```
AU-3 #3 -> As Above
```

The output will look like:

```
1,2,0  
0,0,0,0,0,0,0,0,0,0,0,0,0,0,0,0,0,0,0,0,0,0,0,0,0,0,0,0,0,0,0,0  
1,1,1,0,0,1,0,0,0,0,0,0,0,0,0,0,0,1,1,0,0,0,0,0  
2,2,2,2,2,2,2,2,2,2,2,2,2,2,2,2,2,2,2,2,2,2,2,2,2,2,2,2,2,2,2,2
```

h) STM-1 AU-3 TU-11

This signal again consists of 3 AU-3s. In this case however, the AU-3's each contain 7 TUG-2's. These TUG-2's each contain 4 TU-11's. In terms of paths the signal comprises 3 paths at the AU-3 level and 84 paths at the TU-11 level. Again the AU-3s are defined as a group on their own. The 84 TU-11 paths are split into 3 groups corresponding to their allocation with the 3 AU-3's. For this configuration, four arrays are returned with the following format:

NOTE: TU-11's designated thus [U-3# - TUG-2# - TU#]

SDH Command Reference

FETCh subsystem

```
AUG -> AU-3#1, AU-3#2, AU-3#3
AU-3 #1 -> [1-1-1],[1-1-2],[1-1-3],[1-1-4],[1-2-1],[1-2-2],[1-2-3],[1-2-4],[1-3-1],[1-3-2],[1-3-3],[1-3-4],[1-4-1],[1-4-2],[1-4-3],[1-4-4],[1-5-1],[1-5-2],[1-5-3],[1-5-4],[1-6-1],[1-6-2],[1-6-3],[1-6-4],[1-7-1],[1-7-2],[1-7-3],[1-7-4]
AU-3 #2 -> As Above
AU-3 #3 -> As Above
```

The output will look like:

```
1,1,1
0,0,0,0,0,0,0,0,0,0,0,0,0,0,0,0,0,0,0,0,0,0,0,0,0,0,0,0,0,0,0,0
1,1,1,1,0,0,1,1,0,0,0,0,0,0,0,0,0,0,0,0,0,1,1,0,0,0,0,0,0,0
2,2,2,2,2,2,2,2,2,2,2,2,2,2,2,2,2,2,2,2,2,2,2,2,2,2,2,2,2,2,2,2
```

i) STM-0 AU-3 TU-2

This signal consists of 1 AU-3 containing 7 TUG-2's. Each TUG-2 contains 1 TU-2. There are therefore 8 paths, 1 at the AU-3 level and 7 at the TU-2 level. In this case the AU-3 path is defined as a group on its own, while the 7 TU-2 paths are also defined as one group. For this configuration, 2 groups are returned with the following format:

```
AU-3 Group -> AU-3
AU-3#1 -> TU-2#1,TU-2#2,TU-2#3,TU-2#4,TU-2#5,TU-2#6,TU-2#7
```

The output will look like:

```
0
1,1,1,0,0,0,0
```

j) STM-0 AU-3 TU-12

This signal again comprises 1 AU-3 containing 7 TUG-2's. However, this time the TUG-2's each contain 3 TU-12's. As before, the AU-3 path is defined as a group on its own, while the 7 TU-2 paths are also defined as one group. For this configuration, 2 groups are returned with the following format:

```
NOTE: TU-12's designated thus [TUG-2# - TU-12#]
```

```
AU-3 Group -> AU-3
```

SDH Command Reference

FETCh subsystem

```
TUG-2      -> [1-1],[1-2],[1-3],[2-1],[2-2],[2-3],[3-1],
              [3-2],[3-3],[4-1],[4-2],[4-3],[5-1],[5-2],
              [5-3],[6-1],[6-2],[6-3],[7-1],[7-2],[7-3]
```

The output will look like:

```
0
1,1,1,0,0,0,0,1,1,1,1,1,1,1,0,0,2,0,0,0,0
```

k) STM-0 AU-3 TU-11

This signal again comprises 1 AU-3 containing 7 TUG-2's. However, this time the TUG-2's each contain 4 TU-11's. As before, the AU-3 path is defined as a group on its own, while the 7 TU-2 paths are also defined as one group. For this configuration, 2 groups are returned with the following format:

NOTE: TU-11's designated thus [TUG-2# - TU-11#]

```
AU-3 Group -> AU-3
TUG-2      -> [1-1],[1-2],[1-3],[1-4],[2-1],[2-2],[2-
              3],[2-4],[3-1],[3-2],[3-3],[3-4],[4-1],[4-2],[4-3],[4-
              4],[5-1],[5-2],[5-3],[5-4],[6-1],[6-2],[6-3],[6-4],[7-
              1],[7-2],[7-3],[7-4]
```

The output will look like:

```
0
1,1,1,1,0,0,0,0,1,1,1,1,1,1,1,1,0,0,0,2,0,0,0,0,0,1
```

l) Unrecognized Structure

When Alarm Scan is operating in AUTO mode, it is possible that due to various signal alarm conditions, it may not be able to determine the structure for a particular group of paths. When this occurs that group is marked as an "Unrecognized Structure". The string returned for such a group is the SCPI NAN - "9.91E+37"

:FETCh:ARRAy:DATA:TELEcom:SDH:TSCan?

Returns (each of one or more rows): <numeric>{,<numeric>}

SDH Command Reference

FETCh subsystem

The results returned are those for the last FULL scan. Results from partial scans are not available. If no full scan has been completed since the instrument was powered up, this command will return -1.

If data is available it is returned as a set of string arrays one for each scanned group. The arrays are separated by a CR/LF pair. A group is defined as a set of scanned paths at either the AU or TU level. The arrays consist of comma separated numerics, one for each tributary scanned. The value of the numeric indicates the status of the scanned tributary. The following values are valid.

Value	State
0	No Problems Detected
1	Alarms or Errors Detected

For a specific signal structure, the format of the returned strings are shown below:

a) STM-1 AU-4 TU-2

This signal consists of 1 AU-4 containing 3 TUG-3's each of which contains 7 TUG-2s. The TUG-2's in turn each contain a TU-2. There are therefore 21 (7*3) tributaries in this signal which must be scanned. The 21 tributaries are arranged as 3 groups of 7 paths with the groups corresponding to the TUG-2 allocation. For this configuration, three arrays are returned with fomats shown below:

```
TUG-3 #1    -> TU#1, TU#2, TU#3, TU#4, TU#5, TU#6, TU#7
TUG-3 #2    -> TU#1, TU#2, TU#3, TU#4, TU#5, TU#6, TU#7
TUG-3 #3    -> TU#1, TU#2, TU#3, TU#4, TU#5, TU#6, TU#7
```

For Example, the output could look like:

```
1, 1, 1, 0, 0, 1, 0
1, 1, 1, 0, 0, 1, 1
0, 0, 0, 0, 1, 0, 0
```

b) STM-1 AU-4 TU-3

This signal consists of 1 AU-4 containing 3 TUG-3's each of which contains 1 TU-3. There are therefore 3 tributaries which must be scanned. The three tributaries are defined as groups corresponding to their allocation within the TUG-3's. For this configuration, three arrays are returned with the following format:

SDH Command Reference

FETCh subsystem

```
TUG-3 #1   -> TU-3 #1
TUG-3 #2   -> TU-3 #2
TUG-3 #3   -> TU-3 #3
```

The output will look something like:

```
0
1
1
```

c) STM-1 AU-4 TU-12

This signal again consists of 1 AU-4 containing 3 TUG-3's. In this case however, the TUG-3's each contain 7 TUG-2's. These TUG-2's each contain 3 TU-12's. There are therefore 63 ($3*7*3$) tributaries which must be scanned. The 63 TU-12 paths are arranged in 3 groups corresponding to their allocation with the 3 TUG-3's. For this configuration, three arrays are returned with the following format:

NOTE: TU-12's designated thus [TUG-3# - TUG-2# - TU#]

```
TUG-3 #1   -> [1-1-1],[1-1-2],[1-1-3],[1-2-1],[1-2-
2],[1-2-3],[1-3-1],[1-3-2],[1-3-3],[1-4-1],[1-4-2],[1-4-
3],[1-5-1],[1-5-2],[1-5-3],[1-6-1],[1-6-2],[1-6-3],[1-7-
1],[1-7-2],[1-7-3]
TUG-3 #2   -> As Above
TUG-3 #3   -> As Above
```

The output will look like:

```
0,0,0,0,0,0,0,0,0,0,0,0,0,0,0,0,0,0,0,0,0,0,0,0,0,0,0,0,0,0,0,0
1,1,1,0,0,1,0,0,0,0,0,0,0,0,0,0,0,0,1,1,0,0,0,0,0
1,1,1,1,1,1,1,1,1,1,1,1,1,1,1,1,1,1,1,1,1,1,1,1,1,1,1,1,1,1,1,1
```

d) STM-1 AU-4 TU-11

This signal again consists of 1 AU-4 containing 3 TUG-3's. In this case however, the TUG-3's each contain 7 TUG-2's. These TUG-2's each contain 4 TU-11's. There are therefore 84 ($3*7*4$) tributaries which must be scanned. The 84 TU-11 paths are arranged in 3 groups corresponding to their allocation with the 3 TUG-3's. For this configuration, three arrays are returned with the following format:

NOTE: TU-11's designated thus [TUG-3# - TUG-2# - TU#]

```
TUG-3 #1   -> [1-1-1],[1-1-2],[1-1-3],[1-1-4],[1-2-
```

SDH Command Reference

FETCh subsystem

```
1],[1-2-2],[1-2-3],[1-2-4],[1-3-1],[1-3-2],[1-3-3],[1-3-4],
[1-4-1],[1-4-2],[1-4-3],[1-4-4],[1-5-1],[1-5-2],[1-5-3],
[1-5-4],[1-6-1],[1-6-2],[1-6-3],[1-6-4],[1-7-1],[1-7-2],
[1-7-3],[1-7-4]
TUG-3 #2    -> As Above
TUG-3 #3    -> As Above
```

The output will look like:

```
0,0,0,0,0,0,0,0,0,0,0,0,0,0,0,0,0,0,0,0,0,0,1,1,1,1,1,1,1,
1,1,1,0,0,1,0,0,0,0,0,0,0,0,0,0,0,1,1,0,0,0,0,0,0,0,0,1,0,0
1,1,1,1,1,1,1,1,1,1,1,1,1,1,1,1,1,1,1,1,1,1,1,1,1,1,1,1,1,1
```

e) STM-0 AU-3 TU-2

This signal consists of 1 AU-3 containing 7 TUG-2's. Each TUG-2 contains 1 TU-2. There are therefore 7 tributaries to be scanned. These are defined as one group and hence for this configuration, 1 array is returned with the following format:

```
AU3 Group -> TU2#1, TU2#2, TU2#3, TU2#4, TU2#5, TU2#6, TU2#7
```

The output will look like:

```
1,1,1,0,0,0,0
```

f) STM-0 AU-3 TU-12

This signal again comprises 1 AU-3 containing 7 TUG-2's. However, this time the TUG-2's each contain 3 TU-12's. There are therefore 21 (7*3) tributaries to be scanned. These are defined as one group and are returned in the following format:

NOTE: TU-12's designated thus [TUG-2# - TU-12#]

```
TUG-2      -> [1-1],[1-2],[1-3],[2-1],[2-2],[2-3],[3-1],
               [3-2],[3-3],[4-1],[4-2],[4-3],[5-1],[5-2],
               [5-3],[6-1],[6-2],[6-3],[7-1],[7-2],[7-3]
```

The output will look like:

```
1,1,1,0,0,0,0,1,1,1,1,1,1,1,0,0,1,0,0,0,0
```

SDH Command Reference

FETCh subsystem

g) STM-0 AU-3 TU-11

This signal again comprises 1 AU-3 containing 7 TUG-2's. However, this time the TUG-2's each contain 4 TU-11's. There are therefore 28 (7*4) tributaries to be scanned. These are defined as one group and are returned in the following format:

NOTE: TU-12's designated thus [TUG-2# - TU-11#]

TUG-2 -> [1-1],[1-2],[1-3],[1-4],[2-1],[2-2],[2-3],[2-4],[3-1],[3-2],[3-3],[3-4],[4-1],[4-2],[4-3],[4-4],[5-1],[5-2],[5-3],[5-4],[6-1],[6-2],[6-3],[6-4],[7-1],[7-2],[7-3],[7-4]

The output will look like:

1,1,1,0,0,0,0,1,1,1,1,1,1,1,0,0,1,0,0,0,0

2) STM-4

For the STM-4 situation, the formats are similar to those defined above for STM-1 except that there will be data returned for all four STM-1's in the signal.

A case which is not described in the formats for STM-1 signals is that of an STM-4 signal with a VC-4 structure. In the STM-1 case this structure is not considered since there is only one tributary in the signal. However in the STM-4 case there are 4 tributaries and the scan is carried out.

In this case each VC-4 is treated as a separate group, hence 4 arrays are returned from the SCPI command:

STM-1 #1 VC-4
STM-1 #2 VC-4
STM-1 #3 VC-4
STM-1 #4 VC-4

The output will look like:

0
0
1
1

:FETCh:ARRay:DATA:TELEcom:SDH:PGRaph?

Returns: <numeric>,<numeric>, <numeric>,
...
<numeric>,<numeric>, <numeric>

SDH Command Reference

FETCh subsystem

Option A3R only. Returns an array of 576 bytes, 2 bytes for each of the possible 288 points on the displayed pointer graph. The 2 bytes at each point indicate the maximum and minimum offset at that point. Each byte has 3 numeric entries separated by commas.

The value of the 3 numeric entries, <range bit>,<validity bit>,<offset value>, provide the following information:

Range bit	Validity Bit	Offset Value	Description
1	1	-18 to +18	Valid in range result
1	0	0	No measurement
1	1	9.91E+37	Alarms during measurement
2	1	0	Offset out of range > +18
0	1	0	Offset out of range < -18

The graph entries are arranged as shown below. Each entry has the format previously described above:

<max offset 1>,<min offset 1>,<max offset 2>,<min offset 2>,
<max offset 3>,<min offset 3>,<max offset 4>,<min offset 4>,
<max offset 5>,<min offset 5>,<max offset 6>,<min offset 6>,
.....
.....

<max offset 287>,<min offset 287>,<max offset 288>,<min offset 288>

Range of valid offset values is -18 thru +18

A typical return array might look like:

1,1,9.91E+37,1,1,9.91E+37,1,1, 0,1,1, 0,1,1, +1,1,1, -2, etc....

:FETCh:ARRAy:DATA:TELEcom:SDH:OCAPture? <numeric>

<numeric =	1 to 8	D4D12 and A1A2
	1 to 16	All other Overhead Channels

Returns (each of one or more rows): <string>,<numeric> ,

(last row): <string>,<numeric>

Returns an array with the number of entries determined by <numeric> and separated by CR/LF.

SDH Command Reference

FETCh subsystem

Each entry consists of an alphanumeric string and a numeric separated by commas. The alphanumeric string provide the hexadecimal value of the captured data. The length of the string depends upon the overhead channel selected for capture, two hexadecimal characters/overhead byte. The numeric indicates the number of frames for which the captured data existed. If this command is issued when a capture is being performed, some entries will contain no data. In this case 9.91E+37 is returned.

The overhead byte or bytes to be captured is specified by :SENS:DATA:TEL:OCAP:CHAN <channel>.

:FETCh:ARRay:DATA:TELEcom:SDH:POVerhead? <numeric>

<numeric> = 1 to 9

Returns the value of the selected path overhead bytes as an array of strings. Each string is in the range "00000000" to "11111111". This is a snapshot of the overhead byte and is captured once per second.

The array always begins with byte 1 of the path overhead and ends with the byte number specified by <numeric>.

Byte Order: (1) J1 (2) B3 (3) C2 (4) G1 (5) F2 (6) H4 (7) Z3 (8) Z4 (9) Z5.

Returns: <string>{,<string>}

:FETCh:ARRay:DATA:TELEcom:SDH:OVERhead? <numeric><numeric><numeric>

<numeric> = 1 to 27
(first parameter)

<numeric> = 1 to 4 (STM-1 number)
(second parameter)

<numeric> = 1 (Columns 1,4,7)
(third parameter)

2 (Columns 2,5,8)

3 (Columns 3,6,9)

Returns the value of the selected transport overhead bytes as an array of strings. Each string is in the range "00000000" to "11111111". This is a snapshot of the overhead byte and is captured once per second.

SDH Command Reference

FETCh subsystem

The array always begins with byte 1 of the transport overhead and ends with the byte number specified by the first parameter.

Number	Name	Number	Name	Number	Name
1	A1	10	H1	19	D7
2	A2	11	H2	20	D8
3	J0/Z0/C1	12	H3	21	D9
4	B1	13	B2	22	D10
5	E1	14	K1	23	D11
6	F1	15	K2	24	D12
7	D1	16	D4	25	S1
8	D2	17	D5	26	Z2/M1
9	D3	18	D6	27	E2

Returns (each of one or more rows): <string>,{<string>}

SONET SCPI Command Reference

OUTPut subsystem, see page 5-4.

SOURce subsystem - Transmitter SONET Settings Commands, see page 5-7.

SONET Mapping Settings, see page 5-11.

SOURce subsystem - Transmitter SONET OVERHEAD SETUP, see page 5-23.

SOURce subsystem - Transmitter SONET Test Function Commands, see page 5-36.

INPut subsystem, see page 5-63.

SENSe subsystem - Receiver SONET Settings, see page 5-67.

SENSe subsystem - Receiver SONET Test Function Commands, see page 5-76.

SENSe subsystem - Alarm Scan Control, see page 5-83.

SENSe subsystem - SONET Tributary Scan Control, see page 5-85.

SENSe subsystem -Optical Power Measurement Settings, see page 5-87.

SENSe subsystem - Result Returning Commands, see page 5-88.

FETCh subsystem, see page 5-99.

SONET Command Reference

SONET Command Reference

SONET Command Reference

This chapter contains detailed information on the SCPI (Standard Commands for Programming Instruments) and IEEE 488.2 common commands you will use when writing programs to control your HP 37717C for SONET operation.

Please also refer to chapter 2 Common Commands for general information on SCPI command formats and for a list of commands that are common to PDH, SDH, SONET, ATM or Jitter operation; they are as follows:

SCPI Command Format

Remote Control Commands

Instrument Options

INSTRument subsystem

SOURce subsystem

SOURce subsystem - Transmitter Common Commands

INPut subsystem

SENSe subsystem

SENSe subsystem - Receiver Common Commands

SENSe subsystem - Test Timing

SENSe subsystem - Analysis Control

SENSe subsystem - Trouble Scan Results

SENSe subsystem - Configuring Graphics

SENSe subsystem - Managing Graphics Stores

SENSe subsystem - Retrieving Graphics Store Data

SENSe subsystem - Retrieving Data for a Single Graph

SENSe subsystem - Obtaining Graphics End of Measurement Results

STATus Subsystem

SYSTem Subsystem

IEEE common capabilities

OUTPut subsystem**OUTPut subsystem**

This subsystem controls the characteristics of the instrument's output ports.

:OUTPut:TELEcom:SONet:RATE <discrete>

<discrete> =	STS1	STS-1 Electrical
	STS3	STS-3 Electrical

Is only valid when :SOURce:DATA:TELEcom:SOURce <discrete> is set to <SONet>.

:OUTPut:TELEcom:SONet:RATE?

Returns: <discrete>

:OUTPut:TELEcom:SONet:LEVel <discrete>

<discrete> =	XCON	450 feet simulated cable
	HIGH	0 feet simulated cable
	LOW	900 feet simulated cable

Selects the signal level for the STS-1 output.

The corresponding query returns the STS-1 signal level in discrete short form.

:OUTPut:TELEcom:SONet:LEVel?

Returns: <discrete>

:OUTPut:TELEcom:OC3:RATE?

Returns: <rate>

Always returns OC3. Is only valid when Option UH1, OC-3 Optical Interface, is fitted and :SOURce:DATA:TELEcom:SOURce <discrete> is set to OC3.

:OUTPut:TELEcom:OC12:RATE <discrete>

<discrete> =	OC1	OC-1 optical
--------------	-----	--------------

SONET Command Reference

OUTPut subsystem

OC3	OC-3 Optical
OC12	OC-12 Optical

Selects the output rate for the OC-1/OC-3/OC-12 optical output port. This command is only valid when :SOURce:DATA:TELEcom:SOURce <discrete> is set to OC12.

The corresponding query returns the OC-1/OC-3/OC-12 output rate in discrete form as listed above. If the OC-12 port is not selected, OC12 will be returned as the default.

:OUTPut:TELEcom:OC12:RATE?

Returns : <discrete>

:OUTPut:TELEcom:OC12:INTerface <discrete>

<discrete> =	OPTical	Optical output
	BINary	Binary output

Selects the output interface on the Optical module and is only applicable if option 0YH is present.

The corresponding query returns the selected interface in discrete form, as listed above.

:OUTPut:TELEcom:OC12:INTerface?

Returns: <discrete>

:OUTPut:TELEcom:OC12:INTerface:BINary:CLOCK:POLarity <discrete>

<discrete> =	INVerted	Clock inverted
	NORMal	Clock not inverted

Selects the polarity of the binary clock output on the Optical module and is only applicable if option 0YH is present.

The corresponding query returns the polarity of the binary clock output in discrete form, as listed above.

OUTPut subsystem

:OUTPut:TELEcom:OC12:INTErface:BINary:CLOCK:POLarity?

Returns : <discrete>

:OUTPut:TELEcom:OC12:INTErface:BINary:DATA:POLarity <discrete>

<discrete> =	INVerted	Data inverted
	NORMAl	Data not inverted

Selects the polarity of the binary data output of the Optical module and is only applicable if option 0YH is present.

The corresponding query returns the polarity of the binary data output in discrete form, as listed above.

:OUTPut:TELEcom:OC12:INTErface:BINary:DATA:POLarity?

Returns : <discrete>

:OUTPut:TELEcom:OC12:WAVelength <discrete>

<discrete> =	NM1310	1310 nm
	NM1550	1550 nm

Selects the wavelength of the output optical signal on the Optical module Option 130 only.

The corresponding query returns the output optical wavelength in discrete form, as listed above.

:OUTPut:TELEcom:OC12:WAVelength?

Returns : <discrete>

SOURCE subsystem - Transmitter SONET Settings Commands**SONET Clock settings****:SOURCE:CLOCK:SONet:SOURCE <discrete>**

<discrete> =	INTernal	Internal
	EXTernal	External Clock/Data
	RSTS1	STS-1 Electrical
	ROC1	OC-1 Optical
	RMN1	STS-1 Monitor
	RBN1	STS-1 Binary
	RSTS3	STS-3 Electrical
	ROC3	OC-3 Optical (Option UH1 only)
	RMN3	STS-3 Monitor
	RBN3	STS-3 Binary
	ROC12	OC-12 Optical
	RMN12	STS-12 Monitor
	RBN12	STS-12 Binary

Selects the SONET transmitter clock sync source. If the RX is set to an STS rate, then the only received clock rate that may be selected is the one in use. This restriction does not apply if the RX is set to a non STS rate. If EXT is selected, the Format is set using :SOURCE:CLOCK:SONet:FORMat <discrete>.

The corresponding query returns the transmitter SONET clock sync source in discrete form as listed above.

:SOURCE:CLOCK:SONet:SOURCE?

Returns : <discrete>

:SOURCE:CLOCK:SONet:FORMat <discrete>

<discrete> =	CLOCK	Clock Format
	DATA	Data Format

SOURce subsystem - Transmitter SONET Settings Commands

K64	64kb/s data
DS1Bits	DS1 bit rate

Selects the transmitter SONET EXT clock sync source format.

The corresponding query returns the EXT clock sync source format in discrete form as listed above.

:SOURce:CLOCK:SONet:FORMat?

Returns : <discrete>

:SOURce:CLOCK:SONet:FOFFset <boolean>

<boolean> = 0 or OFF
1 or ON

Enables/disables the SONET Frequency Offset. The amount of Offset is set using :SOURce:CLOCK:SONet:FOFFset:OFFSet <numeric>,<suffix>.

The corresponding query returns the SONET Frequency Offset state as 0 or 1.

:SOURce:CLOCK:SONet:FOFFset?

Returns : <boolean>

:SOURce:CLOCK:SONet:FOFFset:OFFSet <numeric>,<suffix>

<numeric> =	-999 to +999	Parts per Million
	-0.0999 to 0.0999	% or Ratio
<suffix> =	PPM	Parts per Million
	PCT	Percentage

Sets the amount of SONET Frequency Offset when Frequency Offset is enabled by setting :SOURce:CLOCK:SONet:FOFFset <boolean> to ON. If Ratio is chosen as the method of specifying Offset, no suffix is required.

The corresponding query returns the amount of SONET Frequency Offset in ppm.

:SOURce:CLOCK:SONet:FOFFset:OFFSet?

SOURCE subsystem - Transmitter SONET Settings Commands

Returns : <numeric>

Thru mode settings

:SOURCE:DATA:TELEcom:SONet:THRumode <discrete>

<discrete> =	INTernal	Select Normal SONET Mode
	THRU	Select SONET Thru Mode

Selects/Deselects SONET THRU mode.

The corresponding query returns the THRU mode state in discrete form as listed above.

:SOURCE:DATA:TELEcom:SONet:THRumode?

Returns : <discrete>

:SOURCE:DATA:TELEcom:SONet:THRumode:POVerwrite <payload>

<discrete> =	OFF	Payload Overwrite Off
	STS3c	Overwrite STS-3C payload
	STS1	Overwrite STS-1 payload
	VT6	Overwrite VT-6 payload
	VT2	Overwrite VT-2 payload
	VT15	Overwrite VT-1.5 payload

Selects the type of thru-mode payload to overwrite.

Note that the channel number must be selected before entering thru-mode because it is fixed while in thru-mode.

The corresponding query returns the payload overwrite state in discrete form as listed above.

:SOURCE:DATA:TELEcom:SONet:THRumode:POVerwrite?

Returns : <discrete>

SOURce subsystem - Transmitter SONET Settings Commands

:SOURce:DATA:TELEcom:SONet:THRumode:COVerwrite <boolean>

<boolean> =	0 or OFF	Overhead Overwrite Off
	1 or ON	Overhead Overwrite On

Enables/disables section overhead overwrite.

The corresponding query returns the section overhead overwrite state in discrete form as listed above.

:SOURce:DATA:TELEcom:SONet:THRumode:COVerwrite?

Returns : <boolean>

SONET Mapping Settings

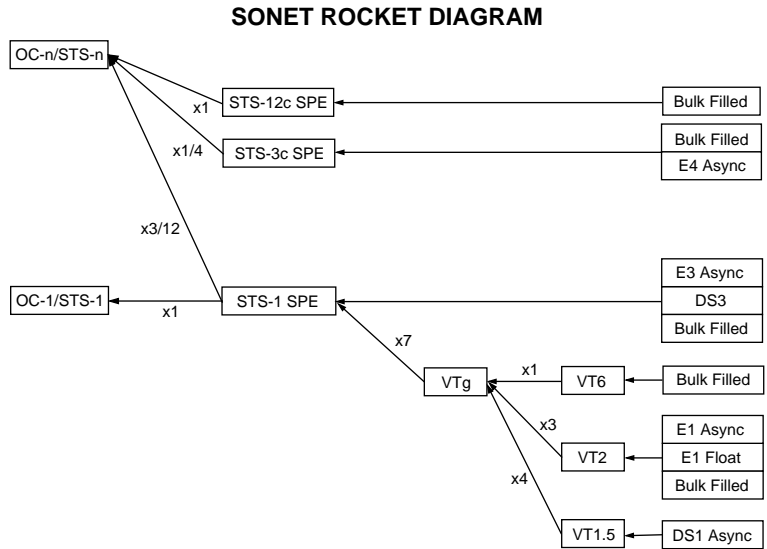

:SOURCE:DATA:TELEcom:SONet:STS3 <numeric>

<numeric> = 1 to 4 STS3 number under test.

Only valid if :OUTPut:TELEcom:OC12:RATE <discrete> is set to a rate higher than STS-3. Selects the transmitted STS-3 that is selected for test.

The corresponding query returns the STS-3 selected for test in numeric form, as listed above.

:SOURCE:DATA:TELEcom:SONet:STS3?

Returns : <numeric>

SPE Layer Selection

:SOURCE:DATA:TELEcom:SONet:SPE:TYPE <discrete>

<discrete> = STS3c

SOURce subsystem - Transmitter SONET Settings Commands

STS1

STS12c

Set the SPE mapping into an STS-N frame.

The corresponding query returns the SPE layer in discrete form as listed above.

:SOURce:DATA:TELEcom:SONet:SPE:TYPE?

Returns: <discrete>

:SOURce:DATA:TELEcom:SONet:STS1 <numeric>

<numeric> = 1 to 3 STS1 Number

Selects the SONET Transmitter active STS-1 within the STS-3.

The corresponding query returns the active STS-1 in numeric form.

:SOURce:DATA:TELEcom:SONet:STS1?

Returns : <numeric>

VT Layer Selection

:SOURce:DATA:TELEcom:SONet:PAYLoad <discrete>

<discrete> =	STS3c or M140	140 Mb/s
	STS1	STS-1
	VT2 or M2	2 Mb/s
	VT6	VT-6
	STS12c	STS-12C (Option 130/131 only)
	VT15 or DS1	VT-1.5

This command selects the SONET transmitter mapping.

The corresponding query returns the SONET mapping in discrete form, as listed above.

:SOURce:DATA:TELEcom:SONet:PAYLoad?

Returns : <discrete>

SOURce subsystem - Transmitter SONET Settings Commands**Payload Layer Selection****:SOURce:DATA:TELEcom:SONet:MAPPING <discrete>**

<discrete> =	M140	140 Mb/s (STS3C only)
	M34	34 Mb/s (STS1 Full SPE only)
	DS3	DS3 (STS1 Full SPE only)
	BULK	Bulk Filled (STS1 or STS3C)

This command controls the transmitter SONET payload for single payload cases.

Only valid if :SOURce:DATA:TELEcom:SONet:PAYLoad <discrete> is set to STS1 or STS3C.

The corresponding query returns the low order mapping in discrete form as listed above.

:SOURce:DATA:TELEcom:SONet:MAPPING?

Returns: <discrete>

:SOURce:DATA:TELEcom:SONet:TRIButary:MAPPING <discrete>

<discrete> =	ASYNc or ASM2	Asynchronous 2 Mb/s
	FBYTe or FLM2	2 Mb/s Floating Byte
	DS1 or ASDS1	Asynchronous 1.544Mb/s DS1
	BULK	Bulk Filled

Selects the transmitter low order mapping. Only valid if

:SOURce:DATA:TELEcom:SONet:PAYLoad <discrete> is set to VT2 or VT15.

The corresponding query returns the low order mapping in discrete short form.

:SOURce:DATA:TELEcom:SONet:TRIButary:MAPPING?

Returns: <discrete>

VT Group**:SOURce:DATA:TELEcom:SONet:VTGRoup <numeric>**

<numeric> = 1 to 7 VT Group

SOURce subsystem - Transmitter SONET Settings Commands

Selects the SONET Transmitter active VT Group within the selected STS1.

The corresponding query returns the active VT Group in numeric form.

:SOURce:DATA:TELEcom:SONet:VTGRoup?

Returns : <numeric>

:SOURce:DATA:TELEcom:SONet:TRIButary <numeric>

<numeric> =	1 to 3	Tributary Number for VT2
	1 to 4	Tributary number for VT-1.5

Selects the SONET Transmitter active VT within the selected VT Group.

The corresponding query returns the active tributary in numeric form.

:SOURce:DATA:TELEcom:SONet:TRIButary?

Returns : <numeric>

VT Payload and Test Pattern**:SOURce:DATA:TELEcom:SONet:PAYLoad:TYPE <discrete>**

<discrete> =	UNFRamed	No framing
	FRAMed	8, 34 & 140 Mb/s
	PCM30	2 Mb/s Only
	PCM31	2 Mb/s Only
	PCM30CRC	2 Mb/s Only
	PCM31CRC	2 Mb/s Only
	IM2	2 Mb/s Insert
	IM34	34 Mb/s Insert
	IM140	140 Mb/s Insert
	D4	DS1 Framing Only
	ESF	DS1 Framing Only
	SLC96	DS1 Framing Only
	M13	DS3 Framing Only

SONET Command Reference

SOURce subsystem - Transmitter SONET Settings Commands

CBIT	DS3 Framing Only
IDS1	Insert DS1
IDS3	Insert DS3

To set the framing type to be structured use the command

:SOURce:DATA:TELEcom:SONet:PAYLoad:STRucture <discrete>.

Only valid if a Structured PDH transmitter is fitted.

The corresponding query returns the framing in discrete form as listed above.

:SOURce:DATA:TELEcom:SONet:PAYLoad:TYPE?

Returns : <discrete>

:SOURce:DATA:TELEcom:SONet:PAYLoad:STRucture <discrete>

<discrete> =	UNSTructured	All rates
	STRuctured	All framed formats

Selects whether or not the PDH payload signal is to have any further structure or not.

The corresponding query returns the transmitter PDH payload structure setting in discrete form as listed above.

:SOURce:DATA:TELEcom:SONet:PAYLoad:STRucture?

Returns: <discrete>

:SOURce:DATA:TELEcom:SONet:PAYLoad:PATtern <discrete>

<discrete> =	PRBS9	2^9-1
	PRBS11	$2^{11}-1$
	PRBS15	$2^{15}-1$
	PRBS20	$2^{20}-1$
	PRBS23	$2^{23}-1$
	QRSS	$2^{20}-1$ with 14 consecutive zero limit (DS1 only)

SOURce subsystem - Transmitter SONET Settings Commands

AZERo	All Zeros
AONE	All Ones
STRESS	3-in-24 stress pattern (DS1 only) (requires option 110)
P1010	Word 1010
P1000	Word 1000
UWORD	16 Bit User Word

Selects the transmitter SONET payload data pattern.

If UWORD is selected, the word pattern is set using
:SOURce:DATA:TELEcom:SONet:PAYLoad:UWORD <string>.

The corresponding query returns the transmitter SONET payload data pattern in discrete form, as listed above.

:SOURce:DATA:TELEcom:SONet:PAYLoad:PATtern?

Returns : <discrete>

:SOURce:DATA:TELEcom:SONet:PAYLoad:UWORD <string>

Sets the SONET transmitter user word pattern in the range "0000000000000000" to "1111111111111111".

The corresponding query returns the user word pattern as a string.

:SOURce:DATA:TELEcom:SONet:PAYLoad:UWORD?

Returns : <string>

:SOURce:DATA:TELEcom:SONet:PRBS:POLarity <discrete>

<discrete> = INVerted
 NORMal

Selects the PRBS pattern polarity.

The corresponding query returns the polarity in discrete form as listed above.

SOURce subsystem - Transmitter SONET Settings Commands

:SOURce:DATA:TELEcom:SONet:PRBS:POLarity?

Returns: <discrete>

:SOURce:DATA:TELEcom:SONet:PAYLoad:OFFSet <numeric>

<numeric> =	-100 to +100	Parts per Million
	-0.0100 to 0.0100	% or Ratio
<suffix> =	PPM	Parts per Million
	PCT	Percentage

Sets the 140, 34, 2 Mb/s, DS3 or DS1 payload frequency offset in parts per million (ppm).

The corresponding query returns the offset in numeric form.

:SOURce:DATA:TELEcom:SONet:PAYLoad:OFFSet?

Returns: <numeric> ppm

:SOURce:DATA:TELEcom:SONet:TRIButary:CONCatenate <numeric>, <numeric>

<numeric> = (first parameter)	0	Concatenation Off
	2	VT6-2C
	3	VT6-3C
	4	VT6-4C
	5	VT6-5C
	6	VT6-6C
<numeric> = (second parameter)	1 to 6	VT6-2C selected
	1 to 5	VT6-3C selected
	1 to 4	VT6-4C selected

SOURce subsystem - Transmitter SONET Settings Commands

1 to 3	VT6-5C selected
--------	-----------------

1 to 2	VT6-6C selected
--------	-----------------

Selects the VT6 concatenation (first parameter) and starting at VT (second parameter).

The corresponding query returns the VT6 concatenation and starting at VT in numeric form as listed above.

:SOURce:DATA:TELEcom:SONet:TRIButary:CONCatenate?

Returns : <numeric>, <numeric>

Background Settings**:SOURce:DATA:TELEcom:SONet:STS1:BACKground:PAYLoad:TYPE
<numeric>, <discrete>**

<numeric>	1 to 3	Background STS-1 channel
<discrete> =	VT15	VT-1.5
	VT2	VT-2
	UWORD	User word

Selects the mapping type for the selected transmitter background STS-1 SPE. The user word can be set up using the command

:SOURce:DATA:TELEcom:SONet:STS1:BACKground:PAYLoad:PATTern:UWORD <numeric>, <string>. This is only valid if the STS-1 selected is not the active foreground.

The corresponding query returns the selected STS-1 mapping type in discrete form as listed above.

**:SOURce:DATA:TELEcom:SONet:STS1:BACKground:PAYLoad:TYPE?
<numeric>**

<numeric>	1 to 3	Background STS-1 channel
-----------	--------	--------------------------

Returns: <discrete>

SOURce subsystem - Transmitter SONET Settings Commands

:SOURce:DATA:TELEcom:SONet:STS1:BACKground:PAYLoad:PATtern:UWORD <numeric>, <string>

<numeric> =	1 to 3	Background STS-1 Channel
<string> =	00000000 to 11111111	User word value in binary

Sets the selected background STS-1 user word value. This is only valid if the STS-1 selected is not the active foreground.

The corresponding query returns the selected background STS-1 user word value in binary string form.

:SOURce:DATA:TELEcom:SONet:STS1:BACKground:PAYLoad:PATtern:UWORD? <numeric>

<numeric>	1 to 3	Background STS-1 channel
Returns	<string>	

:SOURce:DATA:TELEcom:SONet:PRIMary:BACKground:PAYLoad:PATtern <discrete>

<discrete> =	PRBS9	2^9-1
	PRBS15	$2^{15}-1$
	NUMBered	(VT-6 or framed VT-2/VT-1.5)
	P1100	word 1100

Selects the background payload pattern for VTs within the foreground VT Group. The corresponding query returns the background pattern in discrete form as listed above.

:SOURce:DATA:TELEcom:SONet:PRIMary:BACKground:PAYLoad:PATtern?

Returns:	<discrete>
----------	------------

:SOURce:DATA:TELEcom:SONet:STS3:BACKground <discrete>

<discrete> =	FIXed	Fixed at 00000000
	AS_FG	As Foreground

SONET Command Reference

SOURce subsystem - Transmitter SONET Settings Commands

Selects the payload in the background (non test) STS-3s. This command only applies if the interface rate is higher than STS-3.

The corresponding query returns the type of payload in the background STS-3s in discrete short form.

:SOURce:DATA:TELEcom:SONet:STS3:BACKground?

Returns: <discrete>

SOURce subsystem - Transmitter SONET OVERHEAD SETUP**SOURce subsystem - Transmitter SONET OVERHEAD SETUP**

Lists the settings for the commands associated with the TRANSMIT OVERHEAD SETUP display.

:SOURce:DATA:TELEcom:SONet:OVERhead:DEFAULT

Sets all overhead bytes to their default value :

Byte	Value	Byte	Value	Byte	Value	Byte	Value
A1	11110110	A2	00101000	C1/J0	00000001	B1	xxxxxxxx
E1	00000000	F1	00000000	D1	00000000	D2	00000000
D3	00000000	E2	00000000	H1	xxxx10xx	H2	xxxxxxxx
H3	xxxxxxxx	B2	xxxxxxxx	K1	00000000	K2	00000000
D4	00000000	D5	00000000	D6	00000000	D7	00000000
D8	00000000	D9	00000000	D10	00000000	D11	00000000
D12	00000000	S1/Z1	00000000	Z2/M1/M0	00000000	J1	Default
B3	xxxxxxxx	C2	00000001	G1	00000000	F2	00000000
H4	00000000	Z3	00000000	Z4	00000000	N1	00000000

:SOURce:DATA:TELEcom:SONet:OVERhead:DATA <numeric>, <numeric>, <discrete>, <string>

<numeric> = STS-3 Number: range 1 to 4
(first parameter)

<numeric> = STS-1 Number: range 1 to 3
(second parameter)

<discrete> = A1|A2|C1/J0/Z0|E1|F1|D1|D2|D3|H1|K1|
K2|D4|D5|D6|D7|D8|D9|D10|D11
D12|S1/Z1|Z2/M1/M0|E2|X21|X22|X23
X31|X32|X33|X52|X53|X61|X62|X63
X71|X72|X73|X81|X82|X83|X93

<string> = "00000000" to "11111111"

SOURce subsystem - Transmitter SONET OVERHEAD SETUP

Sets the binary value for the selected transmitter section overhead byte. The byte number is given by its defined name if it has one. Undefined bytes are represented by "Xrc", where r is the numerical value of the bytes row in the transport overhead and c is the numerical value of the bytes column in the transport overhead.

If an STS-3 signal is being transmitted, the only applicable value of STS-3 number is 1.

The byte is set to the binary representation of the given 8 character string.

In the case of STS-1 #1 only bits 2 and 3 of H1 may be set. The value sent must however still be 8 bits long. The unused bits should be marked 'x', i.e. to set bits 2 and 3 to '11' send the value 'xxxx11xx'.

C1/J0 byte: To set J0 using this command

:SOURce:DATA:TELEcom:SONet:OVERhead:J0:PATtern <discrete> must be set to "FIXed".

The corresponding query returns the binary value of the byte named within the selected STS-3 column.

:SOURce:DATA:TELEcom:SONet:OVERhead:DATA? <numeric>, <numeric>, <discrete>

Returns : <string>

:SOURce:DATA:TELEcom:SONet:OVERhead:DATA:HEXadecimal <numeric>, <numeric>, <discrete>, <string>

<numeric> = (first parameter)	STS-3 Number: range 1 to 4
<numeric> = (second parameter)	STS-1 Number: range 1 to 3
<discrete> =	A1 A2 J0/Z0 E1 F1 D1 D2 D3 H1 K1 K2 D4 D5 D6 D7 D8 D9 D10 D11 D12 S1/Z1 M0/M1/Z2 E2 X21 X22 X23 X31 X32 X33 X52 X53 X61 X62 X63 X71 X72 X73 X81 X82 X83 X93
<string> =	"00" to "FF"

Sets the hexadecimal value for the selected transmitter transport overhead byte. The byte number is given by its defined name if it has one. Undefined bytes are

SONET Command Reference

SOURce subsystem - Transmitter SONET OVERHEAD SETUP

represented by "Xrc", where r is the numerical value of the bytes row in the transport overhead and c is the numerical value of the bytes column in the transport overhead.

If an STS-3 signal is being transmitted, the only applicable value of STS-3 is 1.

The byte is set to the hexadecimal representation of the given 2 character string.

In the case of STS-1 #1 only bits 2 and 3 of H1 may be set. Any hexadecimal value can be sent but only bits 2 and 3 will be set and all other bits will remain unchanged.

The J0 capability is available at STS-1 and STS-3 only. To set J0 using this command :SOURce:DATA:TELEcom:SONet:OVERhead:J0:PATtern <discrete> must be set to "FIXed".

The corresponding query returns the hexadecimal value of the specified byte.

:SOURce:DATA:TELEcom:SONet:OVERhead:DATA:HEXadecimal?
<numeric>, <numeric>, <discrete>

Returns: <string>

:SOURce:DATA:TELEcom:SONet:POVerhead:DATA <discrete>, <string>

<discrete> = C2|G1|F2|H4|Z3|Z4|N1

<string> = "00000000" to "11111111"

Sets the binary value of the specified STS-3 path overhead byte.

The corresponding query returns the value of the specified STS-3 path overhead byte as a string, as described above.

:SOURce:DATA:TELEcom:SONet:POVerhead:DATA? <discrete>

Returns: <string>

:SOURce:DATA:TELEcom:SONet:POVerhead:SLABel <discrete>

<discrete> =	UNEQuipped	Unequipped (00000000)
	EQUipped	Equipped (00000001)
	VTStructure	VT structure STS-1 SPE (00000010)
	LOCKed	Locked VT (00000011)

SOURce subsystem - Transmitter SONET OVERHEAD SETUP

DS3asyn	Asynchronous DS3 (00000100)
DS4Naasyn	Asynchronous DS4NA (00010010)
ATM	ATM (00010011)
DQDB	DQDB (00010100)
FDDI	FDDI (00010101)
USER	User Defined

Sets the value of the STS POH path label (C2 Byte). To update the USER byte value use the `:SOURce:DATA:TELEcom:SONet:POVerhead:DATA <discrete>, <string>` command.

The corresponding query returns the value of the C2 byte in discrete short form.

:SOURce:DATA:TELEcom:SONet:POVerhead:SLABel?

Returns: <discrete>

:SOURce:DATA:TELEcom:SONet:POVerhead:J1:PATtern <discrete>

<discrete> =	Default	64 NULL characters
	TEST	HP37717C....
	USER	User Defined
	CRC7Test	HP: - GB(serial number)
	CRC7User	User Defined

Sets the type of pattern that is to be transmitted in the J1 byte of the STS path overhead. The pattern repeats every 64 characters (16 chars in CRC7 case) and is transmitted byte by byte in subsequent frames.

The corresponding query returns the type of pattern being transmitted in STS path overhead byte J1 in discrete form as listed above.

:SOURce:DATA:TELEcom:SONet:POVerhead:J1:PATtern?

Returns : <discrete>

:SOURce:DATA:TELEcom:SONet:POVerhead:J1 <string>

Sets the user defined pattern that is to be transmitted in the J1 byte of the STS path overhead. The pattern should be 64 characters long, terminated with CR/LF. If less

SOURce subsystem - Transmitter SONET OVERHEAD SETUP

than 64 characters are input, the instrument will pad with the required number of NULL characters and terminate with CR/LF. The pattern repeats every 64 characters and is transmitted byte by byte in subsequent frames.

The corresponding query returns the value of the user defined pattern as a string, as defined above. If the string contains any non printing characters, ~ is substituted.

If CRC7 was returned in response to

:SOURce:DATA:TELEcom:SONet:POVerhead:J1:PATtern? , this query command is not valid.

:SOURce:DATA:TELEcom:SONet:POVerhead:J1?

Returns : <string>

:SOURce:DATA:TELEcom:SONet:POVerhead:J1:CRC7 <string>

This command sets the CRC7 based user defined string that is to be transmitted using the J1 byte and configures the instrument to use this string. The string can be up to 15 characters in length; remaining characters are set to NULLs. A frame marker byte with CRC7 is added to this string.

The string is transmitted byte by byte in subsequent frames. The string repeats every 16 characters. The corresponding query returns the current value of the string. If the string contains any non printing characters, ~ is substituted.

:SOURce:DATA:TELEcom:SONet:POVerhead:J1:CRC7?

Returns : <string>

:SOURce:DATA:TELEcom:SONet:POVerhead:J1:HEXadecimal?

Returns : <block>

Returns a 64 byte block of data. Each byte represents the hexadecimal value of an ASCII character of STS path overhead byte J1 in the range "00" to "FF". The 64 hexadecimal numbers are preceded by the header "#264".

If CRC7 was returned in response to

:SOURce:DATA:TELEcom:SONet:POVerhead:J1:PATtern?, this query command is not valid.

:SOURce:DATA:TELEcom:SONet:TRIButary:POVerhead:DATA <discrete>, <string>

SONET Command Reference

SOURce subsystem - Transmitter SONET OVERHEAD SETUP

<discrete>=	V5 Z6 Z7
<string>	"00000000 to 11111111" not V5 "xx00xxx0" to "xx11xxx1" for V5

Sets the value of the specific VT-2 or VT-1.5 path overhead byte to the value specified by string (in the range "00000000" to "11111111"). The byte is specified by the first parameter.

Only bits 3, 4 and 8 of V5 can be set but an 8 bit string must be sent with the unsettable bits set to x. To set bits 3, 4 and 8 to "1" send "xx11xxx1".

The corresponding query returns the byte specified by type in string form, as described above.

:SOURce:DATA:TELEcom:SONet:TRIButary:POVerhead:DATA? <discrete>

Returns: <string>

:SOURce:DATA:TELEcom:SONet:OVERhead:J0:PATtern <discrete>

<discrete> =	FIXed	Fixed Byte
	TEST	HP: - GB00000000
	USER	User Defined

Sets the type of pattern that is to be transmitted in the J0 byte of the STS-3 section overhead. The pattern repeats every 16 characters and is transmitted character by character in subsequent frames.

The corresponding query returns the type of pattern being transmitted in overhead byte J0 in discrete short form.

:SOURce:DATA:TELEcom:SONet:OVERhead:J0:PATtern?

Returns: <discrete>

:SOURce:DATA:TELEcom:SONet:OVERhead:J0 <string>

Sets the user defined pattern that is to be transmitted in the J0 byte of the regenerator overhead. The pattern should be 15 characters long. The instrument automatically appends a E.164 CRC character to make up a 16 character sequence. If less than 15 characters are input, the instrument will pad with the required number of NULL characters. The pattern repeats every 16 characters and is transmitted character by character in subsequent frames.

SONET Command Reference

SOURce subsystem - Transmitter SONET OVERHEAD SETUP

The corresponding query returns the value of the user defined pattern as a string, as defined above. If the string contains any non printing characters, ~ is substituted.

If **FIXed** was returned in response

to:**SOURce:DATA:TELEcom:SONet:OVERhead:JO:PATtern?**, this query command is not valid.

SOURce subsystem - Transmitter SONET OVERHEAD SETUP**:SOURce:DATA:TELEcom:SONet:OVERhead:J0?**

Returns: <string>

:SOURce:DATA:TELEcom:SONet:OVERhead:J0:HEXadecimal?

Returns: <block>

Returns a 15 byte block of data. Each byte represents the hexadecimal value of an ASCII character "00" to "FF". The 15 hexadecimal numbers are preceded by the header "#215".

If FIXed was returned in response to

:SOURce:DATA:TELEcom:SONet:OVERhead:J0:PATtern?, this query command is not valid.

**:SOURce:DATA:TELEcom:SONet:TRIButary:POVerhead:J2:PATtern
<discrete>**

<discrete> =	DEFault	15 NULL characters
	TEST	HP: - GB00000000
	USER	User Defined
	FIXed	Fixed Byte

Sets the type of pattern that is to be transmitted in the J2 byte of the VT-6 or VT-2 path overhead. The pattern repeats every 16 characters and is transmitted byte by byte in subsequent frames.

The corresponding query returns the type of pattern being transmitted in VT-6 or VT-2 path overhead byte J2 in discrete form as listed above.

:SOURce:DATA:TELEcom:SONet:TRIButary:POVerhead:J2:PATtern?

Returns : <discrete>

:SOURce:DATA:TELEcom:SONet:TRIButary:POVerhead:J2 <string>

Sets the user defined pattern that is to be transmitted in the J2 byte of the VT-6 or VT-2 path overhead. The pattern should be 15 characters long. If less than 15 characters are input, the instrument will pad with the required number of NULL characters and a frame marker byte with CRC7 is added to the string. The pattern repeats every 16 characters and is transmitted byte by byte in subsequent frames.

SONET Command Reference

SOURce subsystem - Transmitter SONET OVERHEAD SETUP

The corresponding query returns the value of the user defined pattern as a string, as defined above. If the string contains any non printing characters, ~ is substituted.

:SOURce:DATA:TELEcom:SONet:TRIButary:POVerhead:J2?

Returns : <string>

:SOURce:DATA:TELEcom:SONet:TRIButary:POVerhead:J2:HEXadecimal?

Returns : <block>

Returns a 16 byte block of data. Each byte represents the hexadecimal value of an ASCII character of VT-6 or VT-2 byte J2 in the range "00" to "FF". The 15 hexadecimal numbers are preceded by the header "#215".

:SOURce:DATA:TELEcom:SONet:TRIButary:POVerhead:J2:FIXed <string>

<string> = "00000000" to "11111111"

Sets the user defined fixed byte that is to be transmitted in the J2 byte of the VT-6 or VT-2 path overhead. The value is a binary string.

The corresponding query returns the value of the user defined fixed byte as a binary string, as defined above.

:SOURce:DATA:TELEcom:SONet:TRIButary:POVerhead:J2:FIXed?

Returns : <string>

:SOURce:DATA:TELEcom:SONet:TRIButary:POVerhead:V5:SLABel <numeric>

<numeric> = 0 to 7

Sets the VT-6, VT-2 or VT-1.5 signal label (Byte V5) value.

The corresponding query returns the signal label value in numeric form.

:SOURce:DATA:TELEcom:SONet:TRIButary:POVerhead:V5:SLABel?

Returns : <numeric>

SOURce subsystem - Transmitter SONET OVERHEAD SETUP

:SOURce:DATA:TELEcom:SONet:POVerhead:H4Sequence <discrete>

<discrete> =	LONG	Long Sequence
	SHORT	Short Sequence
	COC1	COC1 Sequence

Sets the H4 path overhead byte sequence length when

:SOURce:DATA:TELEcom:SONet:PAYLoad <discrete> is set to "VT6" or "VT2".

The corresponding query returns the H4 byte sequence length in discrete form as listed above.

:SOURce:DATA:TELEcom:SONet:POVerhead:H4Sequence?

Returns : <discrete>

:SOURce:DATA:TELEcom:SONet:OVERhead:SBYTe <discrete>

<discrete> =	SYNChronized	Synchronized - traceability unknown (0000)
	STRatum1	Stratum 1 traceable (0001)
	STRatum2	Stratum 2 traceable (0111)
	STRatum3	Stratum 3 traceable (1010)
	SONet	SONET minimum clock traceable (1100)
	NETWork	Network synchronization (1110)
	DONTusesync	Do not use for synchronization (1111)
	USER	

Selects the SONET SYNC message type (S1 Byte Bits 5 to 8). To update the USER

byte value use either the :SOURce:DATA:TELEcom:SONet:OVERhead:DATA

<numeric>, <numeric>, <discrete>, <string> or the

:SOURce:DATA:TELEcom:SONet:OVERhead:DATA:HEXadecimal <numeric> ,

<numeric>, <discrete>, <string> command.

The corresponding query returns the Sync Message type in discrete form as listed above.

SONET Command Reference

SOURce subsystem - Transmitter SONET OVERHEAD SETUP

:SOURce:DATA:TELEcom:SONet:OVERhead:SBYTe?

Returns :

<discrete>

:SOURCE subsystem - Transmitter SONET Test Function Commands**:SOURCE:DATA:TELEcom:SONet:TFUNCTION:TYPE <discrete>**

<discrete> =	ERRor	Errors & Alarms
	POINter	Pointer
	SEQuence	Overhead sequences
	STESt	Optical Stress
	APSMessages	APS messages
	IDCC	Insert Datacomm
	OBERtest	Overhead BER test

Selects the SONET transmit test function type. STESt is only valid when an optical module is fitted and an optical line rate selected.

The corresponding query returns the test function type in discrete form as listed above.

:SOURCE:DATA:TELEcom:SONet:TFUNCTION:TYPE?

Returns : <discrete>

:SOURCE:DATA:TELEcom:SONet:ERRor:TYPE <discrete>

<discrete> =	BIT	Bit errors
	FRAMe	A1A2 frame errors
	CVS	CV-S (Section B1 BIP)
	CVL	CV-L (Line B2 BIP)
	REIL	REI-L (Line FEBE)
	CVP	CV-P (Path B3 BIP)
	REIP	REI-P (Path FEBE)

SONET Command Reference

:SOURCE subsystem - Transmitter SONET Test Function Commands

CVIec	CV-IEC
CVV	CV-V (VT Path BIP)
REIV	REI-V (VT Path FEBE)

Selects SONET transmit test function error type when :SOURCE:DATA:TELEcom:SONet:TFUNction:TYPE <discrete> is set to "ERR" . Further selection of :SOURCE:DATA:TELEcom:SONet:ERRor:RATE <discrete> is required.

The corresponding query returns the SONET error type in discrete form as listed above.

:SOURCE:DATA:TELEcom:SONet:ERRor:TYPE?

Returns : <discrete>

:SOURCE:DATA:TELEcom:SONet:ERRor:RATE <discrete>

<discrete> =	NONE	Errors Off
	ONCE	Single Error Add, Not Frame errors
	EALL	Error All (Not Frame)
	APSThreshold	APS Threshold (CV-L only)
	E_3	Bit, CV-L, REI-L, CV-V & REI-V only
	E_4	All except Frame errors
	E_5	All except Frame errors
	E_6	All except Frame errors
	E_7	All except Frame errors
	E_8	All except Frame errors
	E_9	All except Frame errors
	ONE	Frame Errors only
	TWO	Frame Errors only

:SOURCE subsystem - Transmitter SONET Test Function Commands

THRee	Frame Errors only
FOUR	Frame Errors only

Selects the transmitter SONET Error rate of the error type selected by :SOURCE:DATA:TELEcom:SONet:ERRor:TYPE <discrete>. This command is applicable when :SOURCE:DATA:TELEcom:SOURce <discrete> is set to SONet.

If bit errors are to be added to the PDH payload then

:SOURCE:DATA:TELEcom:TFUNction <discrete> must be set to "PDHP".

The corresponding query returns the selected transmitter SONET error rate in discrete form, as listed above.

:SOURCE:DATA:TELEcom:SONet:ERRor:RATE?

Returns : <discrete>

:SOURCE:DATA:TELEcom:SONet:PDHPayload:ERRor:TYPE <discrete>

<discrete> =	NONE	
	BIT	Bit errors
	FAS	PDH Frame errors
	MFAS	Multiframe errors (DS3 with Option 110 only)
	FASMfas	PDH Frame and Multiframe errors (DS3 with Option 110 only)
	CRC	CRC-4 errors for 2M, CRC-6 Errors for DS1 (Option 110 only)
	PBITs	Parity Bit errors (DS3 with Option 110 only)
	FEBE	FEBE errors (DS3 with Option 110 only)
	REBE	REBE errors

SONET Command Reference

:SOURCE subsystem - Transmitter SONET Test Function Commands

CPBits	C-Parity Bit errors (DS3 with Option 110 only)
EXZ	Excess zeroes

Selects the TX PDH Payload error type. This command is applicable when :SOURCE:DATA:TELEcom:SOURCE <discrete> is set to PDHPayload.

The corresponding query returns the error type in discrete form as listed above.

:SOURCE:DATA:TELEcom:SONet:PDHPayload:ERROR:TYPE?

Returns : <discrete>

:SOURCE:DATA:TELEcom:SONet:PDHPayload:ERROR:RATE <discrete>

<discrete> =	NONE	No errors added
	ONCE	single error added
	E_3	1.0E-3 error rate
	E_4	1.0E-4 error rate
	E_5	1.0E-5 error rate
	E_6	1.0E-6 error rate
	E_7	1.0E-7 error rate
	USER	User defined error rate

Sets the PDH Payload error rate for the error type selected by :SOURCE:DATA:TELEcom:SONet:PDHPayload:ERROR:TYPE <discrete>. This command is applicable when :SOURCE:DATA:TELEcom:SOURCE <discrete> is set to PDHPayload.

The corresponding query returns the error rate in discrete form as listed above.

:SOURCE:DATA:TELEcom:SONet:PDHPayload:ERROR:RATE?

Returns: <discrete>

SONET Command Reference

:SOURce subsystem - Transmitter SONET Test Function Commands

**:SOURce:DATA:TELEcom:SONet:ERRor:APSThreshold:EINTerval
<discrete>**

<discrete> =	MS10	10 milliseconds
	MS100	100 milliseconds
	S1	1 second
	S10	10 seconds
	S100	100 seconds
	S1000	1,000 seconds
	S10000	10,000 seconds

Sets the interval between APS Threshold errors when

:SOURce:DATA:TELEcom:SONet:ERRor:RATE <discrete> is set to "APST" .

The corresponding query returns the APS Threshold error interval in discrete form as listed above.

:SOURce:DATA:TELEcom:SONet:ERRor:APSThreshold:EINTerval?

Returns : <discrete>

:SOURce:DATA:TELEcom:SONet:ALARm <discrete>

<discrete> =	NONE	Alarms Off
	LOS	Loss of Signal
	LOF	Loss of Frame
	SEF	Severely Errored Frame Defect
	AISL	Line AIS (AIS-L)
	RDIL	Line FERF (RDI-L)
	LOPP	Loss of Pointer (LOP-P)
	AISP	Path AIS (AIS-P)
	RDIP	Path FERF (RDI-P)
	PUNEquipped	Path Unequipped (UNEQ-P)

SONET Command Reference

:SOURCE subsystem - Transmitter SONET Test Function Commands

LOPV	VT Loss of Pointer (LOP-V)
AISV	VT Path AIS (AIS-V)
RDIV	VT Path FERF (RDI-V)
LOMultiframe	Multiframe (H4) Loss
VTUNEquipped	VT Unequipped

Selects the TX Test Function alarm type when
:SOURCE:DATA:TELEcom:SONet:TFUNction:TYPE <discrete> is set to "ERR".

The corresponding query returns the SONET alarm type in discrete form as listed above.

:SOURCE:DATA:TELEcom:SONet:ALARm?

Returns : <discrete>

:SOURCE:DATA:TELEcom:SONet:ALARm:SSEFrame

Generates a single Severely Errored Frame alarm.

:SOURCE:DATA:TELEcom:SONet:POINter <discrete>

<discrete> =	BURSt	Adds bursts
	NPOinter	New Pointer
	OFFSet	Adds offset in ppm
	T1105	Adds T1.105/GR-253 sequence

Selects the Pointer adjustment type when
:SOURCE:DATA:TELEcom:SONet:TFUNction:TYPE <discrete> is set to "POIN".

The corresponding query returns the pointer adjustment type in discrete form as listed above.

:SOURCE:DATA:TELEcom:SONet:POINter?

Returns : <discrete>

:SOURCE subsystem - Transmitter SONET Test Function Commands

:SOURCE:DATA:TELEcom:SONet:POINter:TYPE <discrete>

<discrete> = SPE
 VT

Selects the TX pointer type when

:SOURCE:DATA:TELEcom:SONet:TFUNction:TYPE <discrete> is set to "POIN".

The corresponding query returns the pointer type in discrete form as listed above.

:SOURCE:DATA:TELEcom:SONet:POINter:TYPE?

Returns : <discrete>

:SOURCE:DATA:TELEcom:SONet:POINter:DIRection <discrete>

<discrete> = INCRement
 DECRement
 ALTErnate

Selects the direction of the pointer burst adjustment when

:SOURCE:DATA:TELEcom:SONet:TFUNction:TYPE <discrete> is set to "POIN".

The corresponding query returns the pointer burst direction in discrete form as listed above.

:SOURCE:DATA:TELEcom:SONet:POINter:DIRection?

Returns : <discrete>

:SOURCE:DATA:TELEcom:SONet:POINter:IDECrement <numeric>

<numeric> = 1 to 10 SPE
 1 to 5 VT-6, VT-2, VT-1.5

Selects the number of places by which the pointer is to be incremented or decremented when :SOURCE:DATA:TELEcom:SONet:TFUNction:TYPE <discrete> is set to "POIN" and :SOURCE:DATA:TELEcom:SONet:POINter <discrete> is set to "BURS" .

:SOURCE subsystem - Transmitter SONET Test Function Commands

The corresponding query returns the number of places in numeric form.

:SOURCE:DATA:TELEcom:SONet:POINter:IDECrement?

Returns : <numeric>

:SOURCE:DATA:TELEcom:SONet:POINter:TRANsmitted?

Returns: <numeric>

Returns the currently transmitted value of the SPE pointer in numeric form.

:SOURCE:DATA:TELEcom:SONet:POINter:ACTion

Forces the new pointer value defined by

:SOURCE:DATA:TELEcom:SONet:POINter:VALue <numeric> to be adopted.

:SOURCE:DATA:TELEcom:SONet:POINter:VALue <numeric>

<numeric> = 0 to 782

Selects the SPE New Pointer value when

:SOURCE:DATA:TELEcom:SONet:TFUNction:TYPE <discrete> is set to "POIN"
and :SOURCE:DATA:TELEcom:SONet:POINter <discrete> is set to "NPO".

The corresponding query returns the new pointer value in numeric form as listed above.

:SOURCE:DATA:TELEcom:SONet:POINter:VALue?

Returns : <numeric>

:SOURCE:DATA:TELEcom:SONet:TRIButary:POINter:TRANsmitted?

Returns: <numeric>

Returns the currently transmitted value of the VT pointer in numeric form.

:SOURCE subsystem - Transmitter SONET Test Function Commands

:SOURCE:DATA:TELEcom:SONet:TRIButary:POINter:VALue <numeric>

0 to 427	for VT-6
0 to 139	for VT-2
0 to 103	for VT-1.5

Selects the VT New Pointer value when

:SOURCE:DATA:TELEcom:SONet:TFUNction:TYPE <discrete> is set to "POIN" and :SOURCE:DATA:TELEcom:SONet:POINter <discrete> is set to "NPO".

The corresponding query returns the new pointer value in numeric form as listed above.

:SOURCE:DATA:TELEcom:SONet:TRIButary:POINter:VALue?

Returns : <numeric>

:SOURCE:DATA:TELEcom:SONet:POINter:NPOINter <discrete>

<discrete> =	NDF	With New Data Flag
	NNDF	Without New Data Flag

Selects the type of new pointer when

:SOURCE:DATA:TELEcom:SONet:TFUNction:TYPE <discrete> is set to "POIN" and :SOURCE:DATA:TELEcom:SONet:POINter <discrete> is set to "NPO".

The corresponding query returns the type of new pointer in discrete form as listed above.

:SOURCE:DATA:TELEcom:SONet:POINter:NPOINter?

Returns : <discrete>

:SOURCE:DATA:TELEcom:SONet:POINter:ADJust

Adjust pointer to new settings if :SOURCE:DATA:TELEcom:SONet:POINter <discrete> is set to BURS or NPO .

:SOURCE subsystem - Transmitter SONET Test Function Commands

:SOURCE:DATA:TELEcom:SONet:POINter:OFFSet <discrete>

<discrete> =	SIGNAL	Line offset
	SPE	SPE rate offset
	VT	VT rate offset

Determines whether the Output signal rate, SPE Rate or VT rate is offset.

The corresponding query returns the signal Rate, which is offset, in discrete form as listed above.

:SOURCE:DATA:TELEcom:SONet:POINter:OFFSet?

Returns : <discrete>

**:SOURCE:DATA:TELEcom:SONet:POINter:OFFSet:RATE <numeric>
<suffix>**

<numeric> =	-100 to +100	parts per million
	-0.010 to +0.010	percent
<suffix> =	PPM	parts per million
	PCT	percent

Selects the amount of offset applied to the Output Signal Rate or the SPE Rate or the VT Rate when :SOURCE:DATA:TELEcom:SONet:TFUNction:TYPE <discrete> is set to "POIN" and :SOURCE:DATA:TELEcom:SONet:POINter <discrete> is set to "OFFS".

The default suffix unit is percent.

The corresponding query returns the offset in PPM.

:SOURCE:DATA:TELEcom:SONet:POINter:OFFSet:RATE?

Returns : <numeric>

:SOURce subsystem - Transmitter SONET Test Function Commands

:SOURce:DATA:TELEcom:SONet:POINter:T1105 <discrete>

RSINgle	Repeating single (e)
RBURst	Repeating burst (f)
RPTRansient	Repeating phase transient
PNORmal	Periodic normal (g/h)
PADDED	Periodic added (g/h)
PCANcelled	Periodic cancelled (g/h)

Selects the T1.105/GR-253 Pointer sequence adjustment type when :SOURce:DATA:TELEcom:SONet:TFUNction:TYPE <discrete> is set to "POIN" and :SOURce:DATA:TELEcom:SONet:POINter <discrete> is set to "T1105" .

The corresponding query returns the T1.105/GR-253 adjustment type in discrete form as listed above.

:SOURce:DATA:TELEcom:SONet:POINter:T1105?

Returns : <discrete>

:SOURce:DATA:TELEcom:SONet:POINter:T1105:PATtern <discrete>

<discrete> =	CONTInuous	No pattern
	P873	87:3 pattern
	P261	26:1 pattern

Selects the pattern of the T1.105/GR-253 pointer sequence when :SOURce:DATA:TELEcom:SONet:TFUNction:TYPE <discrete> is set to "POIN" and :SOURce:DATA:TELEcom:SONet:POINter <discrete> is set to "T1105" and :SOURce:DATA:TELEcom:SONet:POINter:T1105 <discrete> is set to "PNOR", "PADD" or "PCAN".

The corresponding query returns the T1.105/GR-253 pattern in discrete form as listed above.

:SOURce:DATA:TELEcom:SONet:POINter:T1105:PATtern?

Returns : <discrete>

:SOURCE subsystem - Transmitter SONET Test Function Commands

:SOURCE:DATA:TELEcom:SONet:POINter:T1105:POLarity <discrete>

<discrete> =	NEGative
	POSitive

Selects the polarity of the T1.105/GR-253 pointer sequence when :SOURCE:DATA:TELEcom:SONet:TFUNction:TYPE <discrete> is set to "POIN" and :SOURCE:DATA:TELEcom:SONet:POINter <discrete> is set to "T1105" and :SOURCE:DATA:TELEcom:SONet:POINter:T1105 <discrete> is set to "SING".

The corresponding query returns the T1.105/GR-253 polarity in discrete form as listed above.

:SOURCE:DATA:TELEcom:SONet:POINter:T1105:POLarity?

Returns : <discrete>

:SOURCE:DATA:TELEcom:SONet:POINter:T1105:INTerval <numeric>, <suffix>

<numeric> =	numeric	See text
<suffix> =	MS	milliseconds
	S	seconds

Selects the interval between T1.105/GR-253 adjustments.

(STS-3C, STS-1) Range is 7.5ms, 10ms, 20ms, 30ms, 34ms, 40ms to 100ms in 10ms steps. 100 ms to 1s in 100ms steps. 1s, 2s, 5s and 10s.

(VT-6, VT-2, VT-1.5) Range is 200ms, 500ms, 1s, 2s, 5s and 10s.

The corresponding query returns the T1.105/GR-253 interval as listed above.

The default suffix unit is seconds.

:SOURCE:DATA:TELEcom:SONet:POINter:T1105:INTerval?

Returns : <numeric>, <suffix>

:SOURCE subsystem - Transmitter SONET Test Function Commands

:SOURCE:DATA:TELEcom:SONet:POINter:T1105:SEQuence <discrete>

<discrete> =	STOP	Stop the current T1.105/GR-253 pointer sequence
	START	Start a T1.105/GR-253 pointer sequence
	INITialize	Start a T1.105/GR-253 pointer sequence preceded by initialization and cooldown

Stops/Starts the T1.105/GR-253 pointer sequence.

The corresponding query returns the sequence start state in discrete form as listed above. See also STAT:SONet2.

:SOURCE:DATA:TELEcom:SONet:POINter:T1105:SEQuence?

Returns : <discrete>

:SOURCE:DATA:TELEcom:SONet:SEQuence <discrete>

<discrete> =	STOP	Stop current sequence
	START	Start new sequence

Starts/Stops a Single or Repeat run Sequence.

The corresponding query returns the Sequence mode in discrete form as listed above.

:SOURCE:DATA:TELEcom:SONet:SEQuence?

Returns : <discrete>

:SOURCE:DATA:TELEcom:SONet:SEQuence:MODE <discrete>

<discrete> =	SINGLE	Single Run
	REPeat	Repeat Run

Selects the type of SEQUENCE when

:SOURCE:DATA:TELEcom:SONet:TFUNction:TYPE <discrete> is set to SEQ.

The corresponding query returns the type of Sequence in discrete form as listed above.

:SOURCE subsystem - Transmitter SONET Test Function Commands

:SOURCE:DATA:TELEcom:SONet:SEQuence:MODE?

Returns : <discrete>

:SOURCE:DATA:TELEcom:SONet:SEQuence:OHBYte <discrete>

<discrete> = A1A2 | J0 | Z0 | E1 | F1 | Section Overhead
D1D3
K1K2 | D4D12 | S1 | Z1 | Line Overhead
Z2 | M1 | M0 | E2
J1 | C2 | G1 | F2 | H4 | Z3 | Path Overhead
Z4 | N1

Selects the overhead byte into which the overhead sequence is to be inserted when :SOURCE:DATA:TELEcom:SONet:TFUNction:TYPE <discrete> is set to SEQ. Some of the parameters are only available in certain STS-1's or STS-3's.

The corresponding query returns the sequenced byte in discrete form as listed above.

:SOURCE:DATA:TELEcom:SONet:SEQuence:OHBYte?

Returns: <discrete>

:SOURCE:DATA:TELEcom:SONet:SEQuence:STS1 <numeric>

<numeric> 1 to 3 STS-1 Number of byte to sequence.

Sets the STS-1 Number of the byte to be sequenced.

The corresponding query returns the STS-1 Number in numeric form.

:SOURCE:DATA:TELEcom:SONet:SEQuence:STS1?

Returns: <numeric>

:SOURCE:DATA:TELEcom:SONet:SEQuence:STS3:SELEct <numeric>

<numeric> = 1 to 4

Only valid if Option 130 is fitted and STS-12/OC-12 selected. Selects STS-3 number for channels that occur in more than one STS-3.

:SOURCE subsystem - Transmitter SONET Test Function Commands

The corresponding query returns the STS-3 number in numeric form.

:SOURCE:DATA:TELEcom:SONet:SEQuence:STS3:SElect?

Returns: <numeric>

:SOURCE:DATA:TELEcom:SONet:SEQuence:DATA <discrete>, <string>

<discrete> = A | B | C | D | E

<string> = "00" to "FFFFFFFFFFFFFFFFFFFF"

Sets the Sequence data pattern for the designated block to the hexadecimal value contained in the string. The number of hexadecimal characters is dependent on the overhead byte or bytes selected. Two hexadecimal characters are required per byte, for Example:

E1 - 1 byte "00" to "FF"

D4D12 - 9 bytes "000000000000000000" to "FFFFFFFFFFFFFFFFFFFF"

The corresponding query returns the hexadecimal value of the designated block as a string.

:SOURCE:DATA:TELEcom:SONet:SEQuence:DATA? <discrete>

Returns : <string>

:SOURCE:DATA:TELEcom:SONet:SEQuence:ORDer <discrete>, <discrete>, <discrete>, <discrete>, <discrete>

<discrete> = A | B | C | D | E

Selects the order of transmission for the blocks of data used in the sequence.

The corresponding query returns the block order in discrete form as listed above.

:SOURCE:DATA:TELEcom:SONet:SEQuence:ORDer?

Returns : <discrete>, <discrete>, <discrete>, <discrete>, <discrete>

:SOURCE subsystem - Transmitter SONET Test Function Commands

:SOURCE:DATA:TELEcom:SONet:SEQuence:FCOunt <numeric>, <numeric>

<numeric> = (first parameter)	1 to 5	Block number
<numeric> = (second parameter)	0 to 64000	Frame count

Selects the number of frames in which the block of data, designated by the block_no, is to be transmitted.

The corresponding query returns the frame count of the block specified in numeric form.

:SOURCE:DATA:TELEcom:SONet:SEQuence:FCOunt? <numeric>

<numeric>=	1 to 5	Block number
Returns :	<numeric>	Frame count

:SOURCE:DATA:TELEcom:SONet:STESt:SPATtern <discrete>

<discrete> =	AZERos	All Zero's pattern
	AONes	All Ones pattern
	G958	G.958 sequence

Selects the pattern used in the STS-3 Optical stress test when is set to STES.

The corresponding query returns the selected pattern in discrete form as listed above.

:SOURCE:DATA:TELEcom:SONet:STESt:SPATtern?

Returns :	<discrete>
-----------	------------

:SOURCE:DATA:TELEcom:SONet:STESt:BLENght <numeric>

<numeric> =	2 to 88	STS-1
	2 to 259	STS-3
	2 to 1042	STS-12

:SOURce subsystem - Transmitter SONET Test Function Commands

Selects the block length used in the SONET Optical stress test when :SOURce:DATA:TELEcom:SONet:TFUNction:TYPE <discrete> is set to STES.

The corresponding query returns the block length in numeric form.

:SOURce:DATA:TELEcom:SONet:STES:BLENgtH?

Returns : <numeric>

:SOURce:DATA:TELEcom:SONet:APSMessages:TOPology <discrete>

<discrete> =	LINEar	Linear protection
	RING	Ring protection

Selects the type of protection topology.

The corresponding query returns the selected protection topology in discrete short form.

:SOURce:DATA:TELEcom:SONet:APSMessages:TOPology?

Returns: <discrete>

:SOURce:DATA:TELEcom:SONet:APSMessages:REQuest <discrete>

<discrete> =	NREQuest	No Request (0000)
	DNRevert	Do Not Revert (0001)
	RREQuest	Reverse Request (0010)
	THRee	Not Used (0011)
	EXERcise	Exercise (0100)
	FIVE	Not Used (0101)
	WTRestore	Wait To Restore (0110)
	SEVen	Not Used (0111)
	MSWitch	Manual Switch (1000)
	NINE	Not Used (1001)

:SOURCE subsystem - Transmitter SONET Test Function Commands

SDLPriority	Signal Degrade Low Priority (1010)
SDHPriority	Signal Degrade High Priority (1011)
SFLPriority	Signal Fail Low Priority (1100)
SFHPriority	Signal Fail High Priority (1101)
FSWitch	Forced Switch (1110)
LOPRotectio	Lockout Of Protection (1111)

Selects the transmitter SONET APS message to be transmitted (K1 Byte, Bits 1 to 4). Only valid if :SOURCE:DATA:TELEcom:TFUNctioN <discrete> is set to SONet and :SOURCE:DATA:TELEcom:SONet:TFUNctioN:TYPE <discrete> is set to APSM. SDHPriority and SFHPriority are only valid when :SOURCE:DATA:TELEcom:SONet:APSMessages:ARCHitecture <discrete> is set to OTN.

The corresponding query returns the selected transmitter SONET APS message type in discrete form, as listed above.

:SOURCE:DATA:TELEcom:SONet:APSMessages:REQuest?

Returns : <discrete>

:SOURCE:DATA:TELEcom:SONet:APSMessages:CHANnel <numeric>

<numeric> =	0	NULL Channel
	1	Working Channel 1
	2	Working Channel 2
	3	Working Channel 3
	4	Working Channel 4
	5	Working Channel 5
	6	Working Channel 6
	7	Working Channel 7
	8	Working Channel 8

:SOURce subsystem - Transmitter SONET Test Function Commands

9	Working Channel 9
10	Working Channel 10
11	Working Channel 11
12	Working Channel 12
13	Working Channel 13
14	Working Channel 14
15	Extra Traffic Channel

Selects the transmitter SONET APS message channel (K1 Byte, Bits 5 to 8). Only valid if :SOURce:DATA:TELEcom:TFUNction <discrete> is set to SONet and :SOURce:DATA:TELEcom:SONet:TFUNction:TYPE <discrete> is set to APSM. Working Channels 1 to 14 are only valid if :SOURce:DATA:TELEcom:SONet:APSMessages:ARCHitecture <discrete> is set to OTN.

The corresponding query returns the selected transmitter SONET APS message channel in numeric form, as listed above.

:SOURce:DATA:TELEcom:SONet:APSMessages:CHANnel?

Returns : <numeric>

:SOURce:DATA:TELEcom:SONet:APSMessages:BRIDge <string>

<string> = "0000" to "1111"

Selects the SONET transmitter Linear APS message bridged channel (K2 Byte, Bits 1 to 4). Only valid if :SOURce:DATA:TELEcom:TFUNction <discrete> is set to SONet and :SOURce:DATA:TELEcom:SONet:TFUNction:TYPE <discrete> is set to APSM and :SOURce:DATA:TELEcom:SONet:APSMessages:TOPology <discrete> is set to LIN.

The corresponding query returns the APS messages bridged channel as a string as listed above.

:SOURce:DATA:TELEcom:SONet:APSMessages:BRIDge?

Returns : <string>

:SOURCE subsystem - Transmitter SONET Test Function Commands**:SOURCE:DATA:TELEcom:SONet:APSMessages:ARCHitecture <discrete>**

<discrete> =	OTONe	1+1
	OTN	1:N

Selects the SONET transmitter Linear APS architecture (K2 Byte, Bit 5). Only valid if :SOURCE:DATA:TELEcom:TFUNCTION <discrete> is set to SONet and :SOURCE:DATA:TELEcom:SONet:TFUNCTION:TYPE <discrete> is set to APSM and :SOURCE:DATA:TELEcom:SONet:APSMessages:TOPology <discrete> is set to LIN.

The corresponding query returns the selected transmitter SONET APS message architecture in discrete form, as listed above.

:SOURCE:DATA:TELEcom:SONet:APSMessages:ARCHitecture?

Returns : <discrete>

:SOURCE:DATA:TELEcom:SONet:APSMessages:REServed <numeric>

<numeric> =	0	000
	1	001
	2	010
	3	011
	4	100
	5	101

Selects the SONET transmitter Linear APS messages reserved bits (K2 Byte, Bits 6 to 8) in numeric form.

Only valid if :SOURCE:DATA:TELEcom:TFUNCTION <discrete> is set to SONet and :SOURCE:DATA:TELEcom:SONet:TFUNCTION:TYPE <discrete> is set to APSM and :SOURCE:DATA:TELEcom:SONet:APSMessages:TOPology <discrete> is set to LIN.

The corresponding query returns the selected transmitter SONET APS message reserved bits in numeric form.

:SOURCE subsystem - Transmitter SONET Test Function Commands**:SOURCE:DATA:TELEcom:SONet:APSMessages:RESERVED?**

Returns: <numeric>

:SOURCE:DATA:TELEcom:SONet:APSMessages:RCODE <discrete>

<discrete> =	NREQuest	No Request (0000)
	RRRing	Reverse Request - Ring (0001)
	RRSPan	Reverse Request - Span (0010)
	ERINg	Exerciser - Ring (0011)
	ESPan	Exerciser - Span (0100)
	WTRestore	Wait to Restore (0101)
	MSRing	Manual Switch - Ring (0110)
	MSSPan	Manual Switch - Span (0111)
	SDRing	Signal Degrade - Ring (1000)
	SDSPan	Signal Degrade - Span (1001)
	SDPRotectioN	Signal Degrade - Protection (1010)
	SFRing	Signal Fail - Ring (1011)
	SFSPan	Signal Fail - Span (1100)
	FSRing	Forced Switch Ring (1101)
	FSSPan	Forced Switch - Span(1110)
	LOPRotectioN	Lockout Of Protection (1111)

Selects the transmitter Ring APS message to be transmitted (K1 Byte, Bits 1 to 4). Only valid if :SOURCE:DATA:TELEcom:TFUNCTION <discrete> is set to SONet and :SOURCE:DATA:TELEcom:SONet:TFUNCTION:TYPE <discrete> is set to APSM and :SOURCE:DATA:TELEcom:SONet:APSMessages:TOPology <discrete> is set to RING.

The corresponding query returns the selected transmitter SONET APS message type in discrete short form.

:SOURCE:DATA:TELEcom:SONet:APSMessages:RCODE?

Returns: <discrete>

:SOURCE:DATA:TELEcom:SONet:APSMessages:DNODE <string>

<string> = "0000" to "1111"

SONET Command Reference

:SOURCE subsystem - Transmitter SONET Test Function Commands

Selects the SONET transmitter Ring APS message destination node (K1 Byte, Bits 5 to 8). Only valid if :SOURCE:DATA:TELEcom:TFUNction <discrete> is set to SONet and :SOURCE:DATA:TELEcom:SONet:TFUNction:TYPE <discrete> is set to APSM and :SOURCE:DATA:TELEcom:SONet:APSMessages:TOPology <discrete> is set to RING.

The corresponding query returns the APS messages destination node as a string as listed above.

:SOURCE:DATA:TELEcom:SONet:APSMessages:DNODE?

Returns: <string>

:SOURCE:DATA:TELEcom:SONet:APSMessages:SNODE <string>

<string> = "0000" to "1111"

Selects the SONET transmitter Ring APS message source node (K2 Byte, Bits 1 to 4). Only valid if :SOURCE:DATA:TELEcom:TFUNction <discrete> is set to SONet and :SOURCE:DATA:TELEcom:SONet:TFUNction:TYPE <discrete> is set to APSM and :SOURCE:DATA:TELEcom:SONet:APSMessages:TOPology <discrete> is set to RING.

The corresponding query returns the APS messages source node as a string as listed above.

:SOURCE:DATA:TELEcom:SONet:APSMessages:SNODE?

Returns: <string>

:SOURCE:DATA:TELEcom:SONet:APSMessages:PCODE <discrete>

<discrete> =	SHORT	Short path
	LONG	Long path

Selects the SONET transmitter Ring APS message path type (K2 bit 5). Only valid if :SOURCE:DATA:TELEcom:TFUNction <discrete> is set to SONet and :SOURCE:DATA:TELEcom:SONet:TFUNction:TYPE <discrete> is set to APSM and :SOURCE:DATA:TELEcom:SONet:APSMessages:TOPology <discrete> is set to RING.

The corresponding query returns the Ring APS messages path type in discrete short form.

:SOURCE subsystem - Transmitter SONET Test Function Commands**:SOURCE:DATA:TELEcom:SONet:APSMessages:PCODE?**

Returns: <discrete>

:SOURCE:DATA:TELEcom:SONet:APSMessages:SCODE <discrete>

<discrete> =	IDLE	Idle (000)
	BRIDged	Bridged (001)
	BASWitched	Bridged & Switched (010)
	P011	011
	P100	100
	P101	101

Selects the SONET transmitter Ring APS messages status code (K2 Byte, Bits 6 to 8). Only valid if :SOURCE:DATA:TELEcom:TFUNCTION <discrete> is set to SONet and :SOURCE:DATA:TELEcom:SONet:TFUNCTION:TYPE <discrete> is set to APSM and :SOURCE:DATA:TELEcom:SONet:APSMessages:TOPology <discrete> is set to RING.

The corresponding query returns the selected transmitter SONET APS message status code in discrete form as listed above.

:SOURCE:DATA:TELEcom:SONet:APSMessages:SCODE?

Returns: <discrete>

:SOURCE:DATA:TELEcom:SONet:APSMessages:DOWNload

Start transmission of the SONET transmitter APS message. Only valid if :SOURCE:DATA:TELEcom:TFUNCTION <discrete> is set to SONet and :SOURCE:DATA:TELEcom:SONet:TFUNCTION:TYPE <discrete> is set to APSM.

:SOURCE:DATA:TELEcom:SONet:IDCC <discrete>

<discrete> =	SDCC	Section DCC
	LDCC	Line DCC

Selects the Data Communication Channel Insert port when :SOURCE:DATA:TELEcom:SONet:TFUNCTION:TYPE <discrete> is set to IDCC .

The corresponding query returns the selected port in discrete form as listed above.

:SOURCE subsystem - Transmitter SONET Test Function Commands

:SOURCE:DATA:TELEcom:SONet:IDCC?

Returns : <discrete>

:SOURCE:DATA:TELEcom:SONet:IDCC:POLarity <discrete>

<discrete> = REVerSed
 NORMAl

Selects the polarity of the DCC Insert port and the DCC Drop port when :SOURCE:DATA:TELEcom:SONet:TFUNction:TYPE <discrete> is set to IDCC .

The corresponding query returns the port polarity in discrete form as listed above.

:SOURCE:DATA:TELEcom:SONet:IDCC:POLarity?

Returns <discrete>

:SOURCE:DATA:TELEcom:SONet:OBERtest:CHANnel <discrete>

<discrete> =	C1 J0 Z0 E1 F1 D1 D2 D3	Section Overhead
	K1 K2 D4 D5 D6 D7	Line Overhead
	D8 D9 D10 D11 D12	
	S1 Z1 M0 M1 Z2 E2	
	J1 C2 G1 F2 H4 Z3	Path Overhead
	Z4 N1	

Selects the TX overhead byte used for the overhead BER test when :SOURCE:DATA:TELEcom:SONet:TFUNction:TYPE <discrete> is set to OBER.

The corresponding query returns the overhead byte identity in discrete form as listed above.

:SOURCE:DATA:TELEcom:SONet:OBERtest:CHANnel?

Returns <discrete>

:SOURCE:DATA:TELEcom:SONet:OBERtest:STS1 <numeric>

<numeric> 1 to 3

SONET Command Reference

:SOURCE subsystem - Transmitter SONET Test Function Commands

Sets the STS-1 Number (within the currently selected STS-3) of the Section Overhead byte currently selected for the overhead bit transmitter error rate test function.

The command is only valid if :SOURCE:DATA:TELEcom:SONet:TFUNction:TYPE <discrete> is set to OBER. It is only applicable when Z0 is selected by :SOURCE:DATA:TELEcom:SONet:OBERtest:CHANnel <discrete>

The corresponding query returns the STS-1 Number in numeric form as described above.

:SOURCE:DATA:TELEcom:SONet:OBERtest:STS1?

Returns: <numeric>

:SOURCE:DATA:TELEcom:SONet:OBERtest:STS3:SELEct <numeric>

<numeric> =	1	All bytes
	2	Z0
	3	Z0, M1
	4	Z0

Only valid if Option 130 is fitted and STS-12/OC-12 is selected. Selects STS-3 number for channels that occur in more than one STS-3:

The corresponding query returns the STS-3 number in numeric form.

:SOURCE:DATA:TELEcom:SONet:OBERtest:STS3:SELEct?

Returns: <numeric>

:SOURCE:DATA:TELEcom:SONet:OBERtest <discrete>

<discrete> = ONCE Single error

Injects a single overhead BER error when

SOURCE:DATA:TELEcom:SONet:TFUNction:TYPE <discrete> is set to OBER.

INPut subsystem

INPut subsystem

This subsystem controls the characteristics of the instrument’s input ports.

:INPut:TELEcom:SONet:RATE <discrete>

<discrete> =	STS1	STS-1 Electrical
	STS3	STS-3 Electrical

Is only valid when the SONET Module is fitted and :SENSe:DATA:TELEcom:SENSe <discrete> is set to SONet.

The corresponding query returns the SONET rate in discrete short form.

:INPut:TELEcom:SONet:RATE?

Returns : <discrete>

:INPut:TELEcom:SONet:LEVel <discrete>

<discrete> =	HIGH	0 feet simulated cable
	LOW	900 feet simulated cable

Selects the signal level for the STS-1 input. Is only valid when the SONET Module is fitted and :INPut:TELEcom:SONet:RATE <discrete> is set to STS1.

The corresponding query returns the STS-1 signal level in discrete short form.

:INPut:TELEcom:SONet:LEVel?

Returns: <discrete>

:INPut:TELEcom:SONet:GAIN <discrete>

<discrete> =	DB20	20 dB Gain
	DB26	26 dB Gain

Selects the Monitor gain for the SONET receiver. Only valid when :INPut:TELEcom:LEVel <discrete> is set to MON.

The corresponding query returns the Monitor gain in discrete short form.

SONET Command Reference

INPut subsystem

:INPut:TELEcom:SONet:GAIN?

Returns: <discrete>

:INPut:TELEcom:OC3:RATE?

Returns : <discrete> OC3

Always returns OC3. Is only valid when Option UH1, OC-3 Optical Interface, is fitted and :SENSe:DATA:TELEcom:SENSe <discrete> is set to OC3.

:INPut:TELEcom:OC12:RATE <discrete>

<discrete> =	OC1	OC-1 optical
	OC3	OC-3 Optical
	OC12	OC-12 Optical

Sets the input rate for the OC-1/OC-3/OC-12 optical input port. Is only valid when Option OC-1/OC-3/OC-12 Optical Interface is fitted and :SENSe:DATA:TELEcom:SENSe <discrete> is set to OC12.

The corresponding query returns the OC-1/OC-3/OC-12 input rate in discrete form, as listed above.

:INPut:TELEcom:OC12:RATE?

Returns : <discrete>

:INPut:TELEcom:OC12:INTerface:BINary:CLOCK:POLarity <discrete>

<discrete> =	INVerted	Clock inverted
	NORMAl	Clock not inverted

Selects the polarity of the binary clock input to the Optical modules and is only valid if option 0YH is fitted.

The corresponding query returns the polarity of the binary clock input in discrete form, as listed above.

SONET Command Reference

INPut subsystem

:INPut:TELEcom:OC12:INTerface:BINary:CLOCK:POLarity?

Returns : <discrete>

:INPut:TELEcom:OC12:INTerface:BINary:DATA:POLarity <discrete>

<discrete> =	INVerted	Data inverted
	NORMAl	Data not inverted

Selects the polarity of the binary data input to the Optical modules and is only valid if option 0YH is fitted.

The corresponding query returns the polarity of the binary data input in discrete form, as listed above.

:INPut:TELEcom:OC12:INTerface:BINary:DATA:POLarity?

Returns : <discrete>

:INPut:TELEcom:OC12:INTerface <discrete>

<discrete> =	OPTical	Optical input
	MONitor	Protected Monitor Input
	BINary	Binary input

Selects the input interface on the Optical modules. BINary is only valid if option 0YH is fitted.

The corresponding query returns the input interface in discrete form, as listed above.

:INPut:TELEcom:OC12:INTerface?

Returns: <discrete>

SENSe subsystem - Receiver SONET Settings

SONET Mapping settings

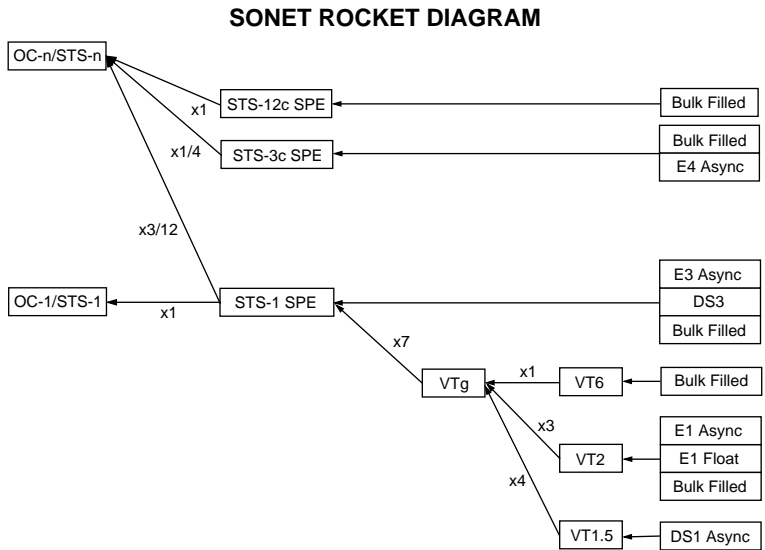

:SENSe:DATA:TELEcom:SONet:STS3 <numeric>

<numeric> = 1 to 4 STS-3 Number under test

Selects the STS-3 number under test. Only valid if :INPut:TELEcom:OC12:RATE <discrete> is set a rate higher than STS3.

The corresponding query returns the test STS3 number.

:SENSe:DATA:TELEcom:SONet:STS3?

Returns : <numeric>

SONET Command Reference
SENSe subsystem - Receiver SONET Settings

SPE Layer Selection

:SENSe:DATA:TELEcom:SONet:SPE:TYPE <discrete>

<discrete> = STS3c
 STS1
 STS12c

Set the SPE mapping into an STS-N frame.

The corresponding query returns the SPE layer in discrete form as listed above.

:SENSe:DATA:TELEcom:SONet:SPE:TYPE?

Returns: <discrete>

:SENSe:DATA:TELEcom:SONet:STS1 <numeric>

<numeric> = 1 to 3 STS1 Number

Selects the SONET Receiver active STS-1 within the STS-3.

The corresponding query returns the active STS-1 in numeric form.

:SENSe:DATA:TELEcom:SONet:STS1?

Returns : <numeric>

VT Layer Selection

:SENSe:DATA:TELEcom:SONet:PAYLoad <discrete>

<discrete> = STS3c *or* M140 140 Mb/s
 STS1 STM-0
 VT2 *or* M2 2 Mb/s
 VT6 VT-6
 STS12c Option 130/131 Only
 VT15 *or* DS1 VT-1.5

This command selects the SONET receiver mapping

SENSe subsystem - Receiver SONET Settings

The corresponding query returns the mapping in discrete form, as listed above.

:SENSe:DATA:TELEcom:SONet:PAYLoad?

Returns : <discrete>

Payload Layer Selection

:SENSe:DATA:TELEcom:SONet:MAPPING <discrete>

<discrete> =	M140	140 Mb/s (STS3C only)
	M34	34 Mb/s (STS1 Full SPE only)
	DS3	DS3 - (STS1 Full SPE only)
	BULK	Bulk Filled (STS1 or STS3C)

Selects the Receiver SONET payload for single payload cases. Only valid if :SENSe:DATA:TELEcom:SONet:PAYLoad <discrete> is set to STS1 or STS3C.

The corresponding query returns the payload in discrete form as listed above.

:SENSe:DATA:TELEcom:SONet:MAPPING?

Returns: <discrete>

:SENSe:DATA:TELEcom:SONet:TRIButary:MAPPING <discrete>

<discrete> =	ASYNc or ASM2	Asynchronous 2 Mb/s
	FBYTe or FLM2	2 Mb/s Floating Byte
	DS1 or ASDS1	Asynchronous 1.544 Mb/s DS1
	BULK	Bulk Filled

Selects the low order mapping. Only valid if :SENSe:DATA:TELEcom:SONet:PAYLoad <discrete> is set to VT2 or VT15.

The corresponding query returns the low order mapping in discrete short form.

:SENSe:DATA:TELEcom:SONet:TRIButary:MAPPING?

Returns: <discrete>

SONET Command Reference
SENSe subsystem - Receiver SONET Settings

:SENSe:DATA:TELEcom:SONet:PRIMary:TS0 <boolean>

<boolean> =	0 or OFF	Data in TS0
	1 or ON	Signaling in TS0

Determines the content of TS0 as Data/Signaling.

The corresponding query returns the TS0 state in numeric form.

:SENSe:DATA:TELEcom:SONet:PRIMary:TS0?

Returns : <boolean> 0 or 1

VT Group

:SENSe:DATA:TELEcom:SONet:VTGRoup <numeric>

<numeric> = 1 to 7

Selects the SONET Receiver active VT Group within the selected STS-1.

The corresponding query returns the active VT Group in numeric form.

:SENSe:DATA:TELEcom:SONet:VTGRoup?

Returns : <numeric>

:SENSe:DATA:TELEcom:SONet:TRIButary <numeric>

<numeric> =	1 to 3	Tributary number for VT-2
	1 to 4	Tributary number for VT-15

Selects the SONET Receiver active VT within the selected VT Group.

The corresponding query returns the receiver test tributary in numeric form.

:SENSe:DATA:TELEcom:SONet:TRIButary?

Returns : <numeric>

SONET Command Reference
SENSe subsystem - Receiver SONET Settings

VT Payload and Test Pattern

:SENSe:DATA:TELEcom:SONet:PAYLoad:TYPE <discrete>

<discrete> =	UNFRamed	No framing
	FRAMed	8, 34 & 140 Mb/s
	PCM30	2 Mb/s
	PCM31	2 Mb/s
	PCM30CRC	2 Mb/s
	PCM31CRC	2 Mb/s
	DM2	Drop 2 Mb/s
	DM34	Drop 34 Mb/s
	DM140	Drop 140 Mb/s
	D4	DS1 Framing
	ESF	DS1 Framing
	SLC96	DS1 Framing
	M13	DS3 Framing
	CBIT	DS3 Framing
	DDS1	Drop DS1
	DDS3	Drop DS3

To set the framing type to be structured use the command
:SENSe:DATA:TELEcom:SONet:PAYLoad:STRUcture <discrete>.

Only valid if a Structured PDH receiver is fitted.

The corresponding query returns the framing in discrete form as listed above.

:SENSe:DATA:TELEcom:SONet:PAYLoad:TYPE?

Returns : <discrete>

:SENSe:DATA:TELEcom:SONet:PAYLoad:STRUcture <discrete>

SONET Command Reference

SENSe subsystem - Receiver SONET Settings

<discrete> =	UNSTructured	All rates
	STRuctured	All framed formats

Determines whether the receiver is to expect any structure in the PDH payload.

The corresponding query returns the receiver structure setting in discrete form as listed above.

:SENSe:DATA:TELEcom:SONet:PAYLoad:STRucture?

Returns: <discrete>

:SENSe:DATA:TELEcom:SONet:PAYLoad:PATtern <discrete>

<discrete> =	PRBS9	2^9-1
	PRBS11	$2^{11}-1$
	PRBS15	$2^{15}-1$
	PRBS20	$2^{20}-1$
	QRSS	$2^{20}-1$ with 14 consecutive zero limit (DS1 only)
	PRBS23	$2^{23}-1$
	AZERo	All Zero's
	AONE	All One's
	STRess	3-in-24 stress pattern (DS1 only) (requires option 110)
	P1010	Word 1010
	P1000	Word 1000
	UWORD	16 Bit User Word
	LIVE	Live Traffic

Selects the receiver SONET payload data pattern.

SONET Command Reference

SENSe subsystem - Receiver SONET Settings

If UWORD is selected, the word pattern is set using
:SENSe:DATA:TELEcom:SONet:PAYLoad:UWORD <string>

The corresponding query returns the receiver SONET payload data pattern in discrete form as listed above.

:SENSe:DATA:TELEcom:SONet:PAYLoad:PATtern?

Returns : <discrete>

:SENSe:DATA:TELEcom:SONet:PAYLoad:UWORD <string>

Sets the receiver user word pattern in the range "0000000000000000" to "1111111111111111".

The corresponding query returns the user word pattern as a string.

:SENSe:DATA:TELEcom:SONet:PAYLoad:UWORD?

Returns : <string>

:SENSe:DATA:TELEcom:SONet:PRBS:POLarity <discrete>

<discrete> = NORMal
 INVerted

Selects the PRBS pattern polarity.

The corresponding query returns the PRBS pattern polarity in discrete form as listed above.

:SENSe:DATA:TELEcom:SONet:PRBS:POLarity?

Returns : <discrete>

**:SENSe:DATA:TELEcom:SONet:TRIButary:CONCatenate
<numeric>,<numeric>**

<numeric> = (first parameter)	0	Concatenation Off
	2	VT6-2C
	3	VT6-3C

SONET Command Reference

SENSe subsystem - Receiver SONET Settings

	4	VT6-4C
	5	VT6-5C
	6	VT6-6C
<numeric> = (second parameter)	1 to 6	VT6-2C selected
	1 to 5	VT6-3C selected
	1 to 4	VT6-4C selected
	1 to 3	VT6-5C selected
	1 to 2	VT6-6C selected

Selects the VT6 concatenation level (first parameter) and starting at the VT (second parameter).

The corresponding query returns the VT6 concatenation and starting VT in numeric form as listed above.

:SENSe:DATA:TELEcom:SONet:TRIButary:CONCatenate?

Returns : <numeric>,<numeric>

SENSe subsystem - Receiver SONET Test Function Commands

Lists the commands associated with the RECEIVE TEST FUNCTION display.

:SENSe:DATA:TELEcom:SONet:TFUNction:TYPE <discrete>

<discrete> =	NONE	Off
	OCAPture	Overhead Capture
	DDCC	DCC Drop
	PGRaph	Pointer Graph
	OBERtest	Overhead BER

Selects the active Receiver Test Function.

The corresponding query returns the active Receiver Test Function, in discrete form as listed above.

:SENSe:DATA:TELEcom:SONet:TFUNction:TYPE?

Returns : <discrete>

:SENSe:DATA:TELEcom:SONet:OCAPture <discrete>

<discrete> =	STOP	Terminates a Capture
	START	Starts a Capture

Starts or terminates an Overhead Capture. Is only valid when :

SENSe:DATA:TELEcom:SONet:TFUNction:TYPE <discrete> is set to OCAP.

The corresponding query returns the current state of the Overhead Capture, in discrete form as listed above.

:SENSe:DATA:TELEcom:SONet:OCAPture?

Returns : <discrete>

:SENSe:DATA:TELEcom:SONet:OCAPture:OHBYte <discrete>

SONET Command Reference

SENSe subsystem - Receiver SONET Test Function Commands

<discrete> =	A1A2 J0 Z0 E1 F1 D1D3	Section Overhead
	H1H2 K1K2 D4D12 S1 Z1	Line Overhead
	Z2 M1 M0 E2	
	J1 C2 G1 F2 H4 Z3 Z4	Path Overhead
	N1	

Selects the overhead byte or bytes to be captured. Is only valid when :
SENSe:DATA:TELEcom:SONet:TFUNction:TYPE <discrete> is set to OCAP.

The corresponding query returns the byte(s) to be captured in discrete form as listed above.

:SENSe:DATA:TELEcom:SONet:OCAPture:OHBYte?

Returns: <discrete>

:SENSe:DATA:TELEcom:SONet:OCAPture:STS1 <numeric>

<numeric> = 1 to 9

Selects the Section overhead column from which to capture. This only applies to Z1 and Z2.

The corresponding query returns the column to be captured in numeric form.

:SENSe:DATA:TELEcom:SONet:OCAPture:STS1?

<numeric>= 1 to 9

:SENSe:DATA:TELEcom:SONet:OCAPture:STS3:SElect <numeric>

<numeric> = 1 to 4

Only valid if a rate higher than STS-3 is selected. Selects STS-3 number for channels that occur in more than one STS-3.

The corresponding query returns the STS-3 number in numeric form.

SENSe subsystem - Receiver SONET Test Function Commands

:SENSe:DATA:TELEcom:SONet:OCAPture:STS3:SElect?

Returns: <numeric>

:SENSe:DATA:TELEcom:SONet:OCAPture:TRIGger <discrete>

<discrete> = OFF
ON
ONNot On Not

Selects the Overhead Capture Trigger mode. If OFF is selected, capture begins immediately. If ON is selected, capture begins when the received data matches the pattern defined by :SENSe:DATA:TELEcom:SONet:OCAPture:TRIGger:PATtern <string>. If ONN is selected, capture begins when the received data does not match the pattern defined by

:SENSe:DATA:TELEcom:SONet:OCAPture:TRIGger:PATtern <string>.

The corresponding query returns the selected Trigger mode, in discrete form as listed above.

:SENSe:DATA:TELEcom:SONet:OCAPture:TRIGger?

Returns : <discrete>

:SENSe:DATA:TELEcom:SONet:OCAPture:TRIGger:PATtern <string>

Sets the Overhead Capture Trigger Pattern to the hexadecimal value contained in the string. The number of hexadecimal characters in the string is dependent on the overhead byte or bytes selected.

Two hexadecimal characters are required per byte, for example:

E1 - 1 Byte - "00" to "FF"

D4D12 - 9 Bytes - "000000000000000000" to "FFFFFFFFFFFFFFFFFFFF"

Is only valid when : SENSe:DATA:TELEcom:SONet:TFUNction:TYPE <discrete> is set to OCAP and :SENSe:DATA:TELEcom:SONet:OCAPture:TRIGger <discrete> is set to ON or ONN

The corresponding query returns the Trigger Pattern selected, as a string as described above.

:SENSe:DATA:TELEcom:SONet:OCAPture:TRIGger:PATtern?

Returns : <string>

SENSe subsystem - Receiver SONET Test Function Commands

:SENSe:DATA:TELeom:SONet:DDCC <discrete>

<discrete> =	SDCC	Section DCC
	LDCC	Line DCC

Selects the DataCommunications channel to be dropped via the rear panel DROP port. Is only valid when :SENSe:DATA:TELeom:SONet:TFUNction:TYPE <discrete> is set to DDCC.

The corresponding query returns the selected DCC, in discrete form as listed above.

:SENSe:DATA:TELeom:SONet:DDCC?

Returns : <discrete>

:SENSe:DATA:TELeom:SONet:DDCC:POLarity <discrete>

<discrete> =	REVersed
	NORMal

Selects the DCC DROP byte polarity. Is only valid when :SENSe:DATA:TELeom:SONet:TFUNction:TYPE <discrete> is set to DDCC.

NOTE

This will also change the TX DCC insert port polarity

The corresponding query returns the DCC polarity in discrete form as listed above.

:SENSe:DATA:TELeom:SONet:DDCC:POLarity?

Returns <discrete>

:SENSe:DATA:TELeom:SONet:PGRaph:PTYPe <discrete>

<discrete> =	STS3C
	STS1
	VT6
	VT2
	VT15

SENSe subsystem - Receiver SONET Test Function Commands

Selects the type of pointer to be captured for pointer graph.

The corresponding query returns the type of pointer, in discrete short form.

:SENSe:DATA:TELEcom:SONet:PGRaph:PTYPE?

Returns: <discrete>

:SENSe:DATA:TELEcom:SONet:PGRaph:CINTerval <discrete>

<discrete> =	SEC1	1 second interval
	SEC5	5 second interval
	SEC20	20 second interval
	MIN1	1 minute interval
	MIN5	5 minute interval
	MIN20	20 minute interval

Selects the pointer graph capture interval.

The corresponding query returns the pointer graph capture interval, in discrete form as listed above.

:SENSe:DATA:TELEcom:SONet:PGRaph:CINTerval?

Returns: <discrete>

:SENSe:DATA:TELEcom:SONet:OBERTest:STS3 <discrete>

<discrete> =	C1/J0 Z0 E1 F1 D1 D2	Section Overhead D3
	K1 K2 D4 D5 D6 D7 D8	Line Overhead D9 D10 D11 D12 S1 M1 M0 E2
	J1 C2 G1 F2 H4 Z3 Z4	Path Overhead N1

Selects the overhead byte used for the overhead BER test. Is only valid when :
SENSe:DATA:TELEcom:SONet:TFUNCTION:TYPE <discrete> is set to OBER .

The corresponding query returns the Overhead byte name in discrete form as listed above.

SENSe subsystem - Receiver SONET Test Function Commands

:SENSe:DATA:TELEcom:SONet:OBERtest:STS3?

Returns <discrete>

:SENSe:DATA:TELEcom:SONet:OBERtest:STS1 <numeric>

<numeric>= 1 to 3

Sets the STS-1 Number (within the currently selected STS-3) of the Section overhead of the channel for the receiver overhead BER test function. This command is only valid if :SENSe:DATA:TELEcom:SONet:TFUNction:TYPE <discrete> is set to OBER and it is only applicable when Z0 is selected by :SENSe:DATA:TELEcom:SONet:OBERtest:CHANnel <discrete>.

The corresponding query returns the STS-1 Number in numeric form as listed above

:SENSe:DATA:TELEcom:SONet:OBERtest:STS1?

Returns: <numeric>

:SENSe:DATA:TELEcom:SONet:OBERtest:STS3:SELEct <numeric>

<numeric> =	1	All bytes
	2	Z0
	3	Z0, M1
	4	Z0

Only valid if a rate higher than STS-3 is selected. Selects STS-3 number for channels that occur in more than one STS-3.

The corresponding query returns the STS-3 number in numeric form.

:SENSe:DATA:TELEcom:SONet:OBERtest:STS3:SELEct?

Returns: <numeric>

SONET Command Reference
SENSe subsystem - Alarm Scan Control

SENSe subsystem - Alarm Scan Control

:SENSe:DATA:TELEcom:SONet:ASCan:MODE <discrete>

<discrete> = AUTomatic Automatic receiver configuration
 RSETtings Fixed receiver configuration

Option A1T, A3R only. Selects the SONET alarm scan mode.

The corresponding query returns the alarm scan mode in discrete short form.

:SENSe:DATA:TELEcom:SONet:ASCan:MODE?

Returns: <discrete>

:SENSe:DATA:TELEcom:SONet:ASCan:BIP <discrete>

<discrete> = OFF Fail if Alarm
 GTE0 Fail if alarm or any BIP error
 GTEE_6 Fail if alarm or BIP ER > 10E-6
 GTEE_3 Fail if alarm or BIP ER > 10E-3

Option A1T, A3R only. Selects the SONET alarm scan BIP error threshold.

The corresponding query returns the alarm scan BIP error threshold in discrete short form.

:SENSe:DATA:TELEcom:SONet:ASCan:BIP?

Returns: <discrete>

:SENSe:DATA:TELEcom:SONet:ASCan <boolean>

<boolean> = 0 or OFF Stop the current alarm scan
 1 or ON Start a new alarm scan

Option A1T, A3R only. Start/Stop the SONET alarm scan.

The corresponding query returns the alarm scan state as 0 or 1.

SONET Command Reference
SENSe subsystem - Alarm Scan Control

:SENSe:DATA:TELEcom:SONet:ASCan?

Returns: <boolean>

SENSe subsystem - SONET Tributary Scan Control

SENSe subsystem - SONET Tributary Scan Control**:SENSe:DATA:TELEcom:SONet:TSCan:PERiod <numeric>,<suffix>**

<numeric> =	1 to 99	
<suffix> =	d	Days
	h	Hours
	m	Minutes
	s	Seconds

Sets the test duration for each tributary.

The corresponding query returns the test duration for each tributary.

:SENSe:DATA:TELEcom:SONet:SONet:TSCan:PERiod?

Returns: <numeric>,<suffix>

:SENSe:DATA:TELEcom:SONet:TSCan:BIP <discrete>

<discrete> =	GTE0	Fail if any BIP error
	GTE_6	Fail if BIP ER > 10E-6
	GTE_3	Fail if BIP ER > 10E-3

Option A1T, A3R only. Selects the SONET tributary scan BIP error threshold.

The corresponding query returns the alarm scan BIP error threshold in discrete short form.

:SENSe:DATA:TELEcom:SONet:TSCan:BIP?

Returns: <discrete>

:SENSe:DATA:TELEcom:SONet:TSCan <boolean>

<boolean> =	0 or OFF	Stop the current tributary scan
	1 or ON	Start a new tributary scan

Option A1T, A3R only. Start/Stop the SONET tributary scan.

SONET Command Reference

SENSe subsystem - SONET Tributary Scan Control

The corresponding query returns the alarm scan state as 0 or 1.

:SENSe:DATA:TELEcom:SONet:TSCan?

Returns: <boolean>

SENSe subsystem - Optical Power Measurement Settings

SENSe subsystem - Optical Power Measurement Settings

:SENSe:DATA:TELEcom:SONet:WAVelength <discrete>

<discrete> =	NM1310	1310 nm
	NM1550	1550 nm

Selects the wavelength of the input optical signal on the Optical module Option USN only, for use as part of the optical power measurement calculation.

The corresponding query returns the input optical wavelength in discrete form, as listed above.

:SENSe:DATA:TELEcom:SONet:WAVelength?

Returns : <discrete>

SENSe subsystem - Result Returning Commands

Frequency Results (SONET)

:SENSe:DATA? <"result">

Result =	"FREQuency:SONet"	RX SONET clock frequency
	"FOFPpm:SONet"	RX SONET clock offset in ppm
	"FOFHz:SONet"	RX SONET clock offset in Hz

SONET Short Term Results

:SENSe:DATA? <"result">

Result =	"ECOunt:SONet:STERm:FRAMe"	Frame error count
	"ERATio:SONet:STERm:FRAMe"	Frame error ratio
	"ECOunt:SONet:STERm:CVS"	Section B1 BIP error count
	"ERATio:SONet:STERm:CVS"	Section B1 BIP error ratio
	"ECOunt:SONet:STERm:CVL"	Line B2 BIP error count
	"ERATio:SONet:STERm:CVL"	Line B2 BIP error ratio
	"ECOunt:SONet:STERm:REIL"	REI-L (Line FEBE) error count
	"ERATio:SONet:STERm:REIL"	REI-L (Line FEBE) error ratio
	"ECOunt:SONet:STERm:CVP"	Path B3 BIP error count
	"ERATio:SONet:STERm:CVP"	Path B3 BIP error ratio
	"ECOunt:SONet:STERm:REIP"	REI-P (Path FEBE) error count
	"ERATio:SONet:STERm:REIP"	REI-P (Path FEBE) error ratio
	"ECOunt:SONet:STERm:CVIec"	CV-IEC error count
	"ERATio:SONet:STERm:CVIec"	CV-IEC error ratio
	"ECOunt:SONet:STERm:TRIB:CVV"	VT Path BIP error count

SONET Command Reference

SENSe subsystem - Result Returning Commands

"ERATio:SONet:STERm:TRIB:CVV"	VT Path BIP error ratio
"ECOut:SONet:STERm:TRIB:REIV"	VT FEBE error count
"ERATio:SONet:STERm:TRIB:REIV"	VT FEBE error ratio

SONET Cumulative Results

:SENSe:DATA? <"result">

Result =	"ECOut:SONet:FRAMe"	Frame error count
	"ERATio:SONet:FRAMe"	Frame error ratio
	"ECOut:SONet:CVS"	Section B1 BIP error count
	"ERATio:SONet:CVS"	Section B1 BIP error ratio
	"ECOut:SONet:CVL"	Line B2 BIP error count
	"ERATio:SONet:CVL"	Line B2 BIP error ratio
	"ECOut:SONet:REIL"	REI-L (Line FEBE) error count
	"ERATio:SONet:REIL"	REI-L (Line FEBE) error ratio
	"ECOut:SONet:CVP"	Path B3 BIP error count
	"ERATio:SONet:CVP"	Path B3 BIP error ratio
	"ECOut:SONet:REIP"	REI-P (Path FEBE) error count
	"ERATio:SONet:REIP"	REI-P (Path FEBE) error ratio
	"ECOut:SONet:CVIec"	CV-IEC error count
	"ERATio:SONet:CVIec"	CV-IEC error ratio
	"ECOut:SONet:TRIB:CVV"	VT Path BIP error count
	"ERATio:SONet:TRIB:CVV"	VT Path BIP error ratio
	"ECOut:SONet:TRIB:REIV"	VT FEBE error count
	"ERATio:SONet:TRIB:REIV"	VT FEBE error ratio
	"ECOut:SONet:OVERhead"	Overhead error count

SONET Command Reference
SENSe subsystem - Result Returning Commands

SONET Section B1 BIP (CV-S) Analysis Results

:SENSe:DATA? <"result">

Result=	"ESECONDS:SONet:CVS:ANALYSIS"	Error Seconds
	"SESECONDS:SONet:CVS:ANALYSIS"	Severely Errored Seconds
	"EBCOUNT:SONet:CVS:ANALYSIS"	Errored block count
	"BBECOUNT:SONet:CVS:ANALYSIS"	Background block error count
	"ESRATIO:SONet:CVS:ANALYSIS"	Error Second Ratio
	"SESRATIO:SONet:CVS:ANALYSIS"	Severely Errored Second Ratio
	"BBERATIO:SONet:CVS:ANALYSIS"	Background Block Error ratio
	"UASECONDS:SONet:CVS:ANALYSIS"	Unavailable seconds

SONET Line B2 BIP (CV-L) Analysis Results

:SENSe:DATA? <"result">

Result=	"ESECONDS:SONet:CVL:ANALYSIS"	Error Seconds
	"SESECONDS:SONet:CVL:ANALYSIS"	Severely Errored Seconds
	"EBCOUNT:SONet:CVL:ANALYSIS"	Errored block count
	"BBECOUNT:SONet:CVL:ANALYSIS"	Background block error count
	"ESRATIO:SONet:CVL:ANALYSIS"	Error Second Ratio
	"SESRATIO:SONet:CVL:ANALYSIS"	Severely Errored Second Ratio
	"BBERATIO:SONet:CVL:ANALYSIS"	Background Block Error ratio
	"UASECONDS:SONet:CVL:ANALYSIS"	Unavailable seconds
	"PUASECONDS:SONet:CVL:ANALYSIS"	Path Unavailable seconds (A1T/A3R only)

SONET Command Reference
SENSe subsystem - Result Returning Commands

SONET Line FEBE (REI-L) Analysis Results

:SENSe:DATA? <"result">

Result=	"ESECONDS:SONet:REIL:ANALYSIS"	Error Seconds
	"SESECONDS:SONet:REIL:ANALYSIS"	Severely Errored Seconds
	"EBCOUNT:SONet:REIL:ANALYSIS"	Errored block count
	"BBECOUNT:SONet:REIL:ANALYSIS"	Background block error count
	"ESRATIO:SONet:REIL:ANALYSIS"	Error Second Ratio
	"SESRATIO:SONet:REIL:ANALYSIS"	Severely Errored Second Ratio
	"BBERATIO:SONet:REIL:ANALYSIS"	Background Block Error ratio
	"UASECONDS:SONet:REIL:ANALYSIS"	Unavailable seconds
	"PUASECONDS:SONet:REIL:ANALYSIS"	Path Unavailable seconds

SONET Path B3 BIP (CV-P) Analysis Results

:SENSe:DATA? <"result">

Result=	"ESECONDS:SONet:CVP:ANALYSIS"	Error Seconds
	"SESECONDS:SONet:CVP:ANALYSIS"	Severely Errored Seconds
	"EBCOUNT:SONet:CVP:ANALYSIS"	Errored block count
	"BBECOUNT:SONet:CVP:ANALYSIS"	Background block error count
	"ESRATIO:SONet:CVP:ANALYSIS"	Error Second Ratio
	"SESRATIO:SONet:CVP:ANALYSIS"	Severely Errored Second Ratio
	"BBERATIO:SONet:CVP:ANALYSIS"	Background Block Error ratio
	"UASECONDS:SONet:CVP:ANALYSIS"	Unavailable seconds
	"PUASECONDS:SONet:CVP:ANALYSIS"	Path Unavailable seconds

SONET Command Reference
SENSe subsystem - Result Returning Commands

SONET Path FEBE (REI-P) Analysis Results

:SENSe:DATA? <"result">

Result=	"ESECONDS:SONet:REIP:ANALYSIS"	Error Seconds
	"SESECONDS:SONet:REIP:ANALYSIS"	Severely Errored Seconds
	"EBCOUNT:SONet:REIP:ANALYSIS"	Errored block count
	"BBECOUNT:SONet:REIP:ANALYSIS"	Background block error count
	"ESRATIO:SONet:REIP:ANALYSIS"	Error Second Ratio
	"SESRATIO:SONet:REIP:ANALYSIS"	Severely Errored Second Ratio
	"BBERATIO:SONet:REIP:ANALYSIS"	Background Block Error ratio
	"UASECONDS:SONet:REIP:ANALYSIS"	Unavailable seconds
	"PUASECONDS:SONet:REIP:ANALYSIS"	Path Unavailable seconds

SONET CV-IEC Analysis Results

:SENSe:DATA? <"result">

Result=	"ESECONDS:SONet:CVIec:ANALYSIS"	Error Seconds
	"SESECONDS:SONet:CVIec:ANALYSIS"	Severely Errored Seconds
	"EBCOUNT:SONet:CVIec:ANALYSIS"	Errored block count
	"BBECOUNT:SONet:CVIec:ANALYSIS"	Background block error count
	"ESRATIO:SONet:CVIec:ANALYSIS"	Error Second Ratio
	"SESRATIO:SONet:CVIec:ANALYSIS"	Severely Errored Second Ratio
	"BBERATIO:SONet:CVIec:ANALYSIS"	Background Block Error ratio
	"UASECONDS:SONet:CVIec:ANALYSIS"	Unavailable seconds

SONET Command Reference
SENSe subsystem - Result Returning Commands

SONET Virtual Tributary Path BIP (CV-V) Analysis Results

:SENSe:DATA? <"result">

Result=	"ESECONDS:SONet:TRIB:CVV:ANALYSIS"	Error Seconds
	"SESECONDS:SONet:TRIB:CVV:ANALYSIS"	Severely Errored Seconds
	"EBCOUNT:SONet:TRIB:CVV:ANALYSIS"	Errored block count
	"BBECOUNT:SONet:TRIB:CVV:ANALYSIS"	Background block error count
	"ESRATIO:SONet:TRIB:CVV:ANALYSIS"	Error Second Ratio
	"SESRATIO:SONet:TRIB:CVV:ANALYSIS"	Severely Errored Second Ratio
	"BBERATIO:SONet:TRIB:CVV:ANALYSIS"	Background Block Error ratio
	"UASECONDS:SONet:TRIB:CVV:ANALYSIS"	Unavailable seconds
	"PUASECONDS:SONet:TRIB:CVV:ANALYSIS"	Path Unavailable seconds

SONET Virtual Tributary Path FEBE (REI-V) Analysis Results

:SENSe:DATA? <"result">

Result =	"ESECONDS:SONet:TRIB:REIV:ANALYSIS"	Error Seconds
	"SESECONDS:SONet:TRIB:REIV:ANALYSIS"	Severely Errored Seconds
	"EBCOUNT:SONet:TRIB:REIV:ANALYSIS"	Errored block count
	"BBECOUNT:SONet:TRIB:REIV:ANALYSIS"	Background block error count
	"ESRATIO:SONet:TRIB:REIV:ANALYSIS"	Error Second Ratio
	"SESRATIO:SONet:TRIB:REIV:ANALYSIS"	Severely Errored Second Ratio
	"BBERATIO:SONet:TRIB:REIV:ANALYSIS"	Background Block Error ratio
	"UASECONDS:SONet:TRIB:REIV:ANALYSIS"	Unavailable seconds
	"PUASECONDS:SONet:TRIB:REIV:ANALYSIS"	Path Unavailable seconds

SONET Command Reference
SENSe subsystem - Result Returning Commands

SONET Block Based Bit Analysis Results

:SENSe:DATA? <"result">

Result =	"ESECONDS:SONet:BLKBit:ANALYSIS"	Error Seconds
	"SESECONDS:SONet:BLKBit:ANALYSIS"	Severely Errored Seconds
	"EBCOUNT:SONet:BLKBit:ANALYSIS"	Errored block count
	"BBECOUNT:SONet:BLKBit:ANALYSIS"	Background block error count
	"ESRATIO:SONet:BLKBit:ANALYSIS"	Error Second Ratio
	"SESRATIO:SONet:BLKBit:ANALYSIS"	Severely Errored Second Ratio
	"BBERATIO:SONet:BLKBit:ANALYSIS"	Background Block Error ratio
	"UASECONDS:SONet:BLKBit:ANALYSIS"	Unavailable seconds

SONET M.2101 Analysis Results

:SENSe:DATA? <"result">

Result =	"ESECONDS:SONet:LOW:RECEIVE:ANALYSIS:M2101"	Low Order Path Receive Direction Errored Seconds
	"SESECONDS:SONet:LOW:RECEIVE:ANALYSIS:M2101"	Low Order Path Receive Direction Severely Errored Seconds
	"UASECONDS:SONet:LOW:RECEIVE:ANALYSIS:M2101"	Low Order Path Receive Direction Unavailable Seconds
	"ESECONDS:SONet:LOW:TRANSMIT:ANALYSIS:M2101"	Low Order Path Transmit Direction Errored Seconds
	"SESECONDS:SONet:LOW:TRANSMIT:ANALYSIS:M2101"	Low Order Path Transmit Direction Severely Errored Seconds
	"UASECONDS:SONet:LOW:TRANSMIT:ANALYSIS:M2101"	Low Order Path Transmit Direction Unavailable Seconds
	"ESECONDS:SONet:HIGH:RECEIVE:ANALYSIS:M2101"	High Order Path Receive Direction Errored Seconds

SONET Command Reference

SENSe subsystem - Result Returning Commands

"SESeconds:SONet:HIGh:RECEive:ANALySis:M2101"	High Order Path Receive Direction Severely Errored Seconds
"UASeconds:SONet:HIGh:RECEive:ANALySis:M2101"	High Order Path Receive Direction Unavailable Seconds
"ESECONDS:SONet:HIGh:TRANsmIT:ANALySis:M2101"	High Order Path Transmit Direction Errored Seconds
"SESeconds:SONet:HIGh:TRANsmIT:ANALySis:M2101"	High Order Path Transmit Direction Severely Errored Seconds
"UASeconds:SONet:HIGh:TRANsmIT:ANALySis:M2101"	High Order Path Transmit Direction Unavailable Seconds
"ESECONDS:SONet:SECTIon:RECEive:ANALySis:M2101"	Section Layer Path Receive Direction Errored Seconds
"SESeconds:SONet:SECTIon:RECEive:ANALySis:M2101"	Section Layer Path Receive Direction Severely Errored Seconds
"UASeconds:SONet:SECTIon:RECEive:ANALySis:M2101"	Section Layer Path Receive Direction Unavailable Seconds
"ESECONDS:SONet:SECTIon:TRANsmIT:ANALySis:M2101"	Section Layer Path Transmit Direction Errored Seconds
"SESeconds:SONet:SECTIon:TRANsmIT:ANALySis:M2101"	Section Layer Path Transmit Direction Severely Errored Seconds
"UASeconds:SONet:SECTIon:TRANsmIT:ANALySis:M2101"	Section Layer Path Transmit Direction Unavailable Seconds

SONET Command Reference
SENSe subsystem - Result Returning Commands

SONET Service Disruption Results

:SENSe:DATA? <"result">

Result =	"SDTest:COUNt:LONG"	Longest error burst
	SDTest:COUNt:SHORT"	Shortest error burst
	"SDTest:COUNt:LAST"	Last error burst

Returns: <range>,<value>

<range> =	0	Result invalid due to receiver configuration
	1	Result valid
	2	Result out of range

Value is returned in milliseconds. If the value is > 2000 or no result is available or the result is not applicable then 9.91E+37 is returned.

SONET Optical Power Result

:SENSe:DATA? <"result">

Result = "OPOWer:SONet" Optical power (dBm)

SONET Pointer Activity Results

:SENSe:DATA? <"result">

Result	"PACTivity:SONet:PVALue"	SPE Pointer value
	"PACTivity:SONet:NDFSeconds"	SPE Pointer NDF seconds
	"PACTivity:SONet:MNDFseconds"	SPE Pointer MNDF seconds
	"PACTivity:SONet:PCOunt"	SPE Pointer +ve Adj Count
	"PACTivity:SONet:PSEConds"	SPE Pointer +ve Adj Seconds
	"PACTivity:SONet:NCOunt"	SPE Pointer -ve Adj Count

SONET Command Reference

SENSe subsystem - Result Returning Commands

"PACTivity:SONet:NSEConds"	SPE Pointer -ve Adj Seconds
"PACTivity:SONet:IOFFset"	Implied SPE Offset
"PACTivity:SONet:TRIButary:PVALue"	VT Pointer Value
"PACTivity:SONet:TRIButary:NDFSeconds"	VT Pointer NDF seconds
"PACTivity:SONet:TRIButary:MNDFseconds"	VT Pointer MNDF seconds
"PACTivity:SONet:TRIButary:PCOunt"	VT Pointer +ve Adj Count
"PACTivity:SONet:TRIButary:PSEConds"	VT Pointer +ve Adj Seconds
"PACTivity:SONet:TRIButary:NCOunt"	VT Pointer -ve Adj Count
"PACTivity:SONet:TRIButary:NSEConds"	VT Pointer -ve Adj Seconds

SONET Alarm Seconds Results

:SENSe:DATA? <"result">

Result =	"ASEConds:PLOSSs"	Power loss
	"ASEConds:SONet:LOS"	Loss Of Signal
	"ASEConds:SONet:LOF"	Loss Of Frame
	"ASEConds:SONet:SEF"	Severely Errored Frame Defect
	"ASEConds:SONet:H4MF"	H4 Multiframe Loss
	"ASEConds:SONet:LOPP"	Loss Of Pointer (LOP-P)
	"ASEConds:SONet:AISL"	Line AIS (AIS-L)
	"ASEConds:SONet:AISP"	Path AIS (AIS-P)
	"ASEConds:SONet:PSLoss"	Pattern Synchronization Loss
	"ASEConds:SONet:RDIL"	Line FERF (RDI-L)
	"ASEConds:SONet:RDIP"	Path FERF (RDI-P)
	"ASEConds:SONet:K1K2"	K1K2 byte change
	"ASEConds:SONet:TRIB:LOPV"	VT Loss Of Pointer (LOP-V)
	"ASEConds:SONet:TRIB:AISV"	VT Path AIS (AIS-V)

SONET Command Reference

SENSE subsystem - Result Returning Commands

"ASEConds:SONet:TRIB:RDIV"	VT Path FERF (RDI-V)
"ASEConds:SONet:OPSL"	Overhead Pattern Sync Loss

FETCh subsystem

FETCh subsystem

The FETCh subsystem is used to retrieve data directly accumulated by the instrument.

:FETCh:STRing:DATA:TELEcom:SONet:J0?

Returns: <string>

The value of the STS-N Section overhead J0 byte is returned as a 16 ASCII character string if CRC7 is not detected, 15 ASCII character string if CRC7 is detected. If the string contains any non printing characters then ~ is substituted. This is a snapshot of the overhead byte and is captured once per second.

:FETCh:STRing:DATA:TELEcom:SONet:J0:HEXadecimal?

Returns: <block>

Returns the value of the STS-N Section overhead J0 byte as 16 hexadecimal numbers if CRC7 is not detected, 15 hexadecimal numbers if CRC7 is detected. Each number is in the range "00" to "FF". The block header is " #216" if CRC7 not detected, " #215" if CRC7 is detected. This is a snapshot of the overhead byte and is captured once per second.

:FETCh:STRing:DATA:TELEcom:SONet:J1?

Returns : <string>

The value of the SPE J1 path trace byte is returned as a, 64 ASCII character, string (15 ASCII characters if CRC7 is detected). If the string contains any non printing characters then ~ is substituted. This is a snapshot of the overhead byte and is captured once per second.

:FETCh:STRing:DATA:TELEcom:SONet:J1:HEXadecimal?

Returns : <block>

Returns the value of the SPE J1 path trace byte as 64 hexadecimal numbers (15 if CRC7 is detected).

SONET Command Reference

FETCh subsystem

Each number is in the range "00" to "FF". The block header is "#264" (" #215" if CRC7 is detected). This is a snapshot of the overhead byte and is captured once per second.

:FETCh:STRing:DATA:TELEcom:SONet:TRIButary:J2?

Returns: <string>

Returns the 15 or 16 byte J2 path trace as a string. The HP 37717C attempts to align the received pattern by detecting the CRC7 byte. If the CRC7 byte is detected, a 15 byte pattern is returned. If the CRC7 byte is not detected, a 16 byte pattern is returned. If the string contains any non-printing characters then ~ is substituted. This is a snapshot of the received path trace and is only updated once per second.

:FETCh:STRing:DATA:TELEcom:SONet:TRIButary:J2:HEXadecimal?

Returns: <block>

Returns the value of the J2 path trace byte as 15 or 16 hexadecimal numbers. The HP 37717C attempts to align the received pattern by detecting the CRC7 byte. If the CRC7 byte is detected, 15 hexadecimal numbers are returned. If the CRC7 byte is not detected, 16 hexadecimal numbers are returned. Each number is in the range "00" to "FF". The block header is "#215" if 15 Hex numbers and "#216" if 16 Hex numbers. This is a snapshot of the overhead byte and is captured once per second.

:FETCh:STRing:DATA:TELEcom:SONet:K1?

Returns : <string>

The value of the MPS K1 byte is returned as an 8 bit string in the range "00000000" to "11111111".

:FETCh:STRing:DATA:TELEcom:SONet:K2?

Returns : <string>

The value of the MPS K2 byte is returned as an 8 bit string in the range "00000000" to "11111111".

:FETCh:STRing:DATA:TELEcom:SONet:S1?

Returns : <string>

SONET Command Reference

FETCh subsystem

The value of the SYNC S1 byte (bits 5-8) is returned as a 4 bit string in the range "0000" to "1111".

:FETCh:SCALar:DATA:TELEcom:SONet:OVERhead?

<numeric>,<numeric>,<discrete>

<numeric> range 1 to 4

=(STS3#)

<numeric> range 1 to 3

=(STS1#)

<discrete> = A1|A2|C1|J0/Z0|B1|E1|F1|D1|D2|D3|H1|H2

H3|K1|K2|D4|D5|D6|D7|D8|D9|D10|D11

D12|S1/Z1|Z2/M1/M0|E2|X13|X21|X22|X23|X31

X32|X33|X52|X53|X61|X62|X63

X71|X72|X73|X81|X82|X83|X93

Returns the selected overhead byte as an 8 bit binary string in the range "00000000" to "11111111". The byte number is given by its defined name if it has one.

Undefined bytes are represented by <Xrc>, where r is the numerical value of the bytes row in the transport overhead and c is the numerical value of the bytes column in the transport overhead. If an STS-3 signal is being transmitted, the only applicable value of STS3# is 1.

:FETCh:SCALar:DATA:TELEcom:SONet:POVerhead:H4Sequence?

Returns: <string>

Obtains the length of the H4 byte sequence.

Returns :	<discrete>	LONG	Long sequence
		SHOR	Short sequence
		UNKN	Unknown sequence

SONET Command Reference

FETCh subsystem

:FETCh:SCALar:DATA:TELEcom:SONet:POVerhead? <discrete>

<discrete> = J1|B3|C2|G1|F2|H4|Z3|Z4|N1

Obtains the value of the named path overhead byte. The value of the named byte is returned as a string in the range "00000000" to "11111111". This is a snapshot of the overhead byte and is captured once per second.

Returns: <string>

:FETCh:SCALar:DATA:TELEcom:SONet:TRIButary:POVerhead? <discrete>

<discrete> = V5|Z6|Z7 VT-6|VT-2|VT-1.5

Obtains the value of the specified path overhead byte. The value of the named byte is returned as a string in the range "00000000" to "11111111". This is a snapshot of the overhead byte and is captured once per second.

Returns: <string>

:FETCh:SCALar:DATA:TELEcom:SONet:TRIButary:POVerhead:SLABel?

Returns the signalling label of the selected tributary in numeric form.

Returns: <numeric>

:FETCh:ARRAy:DATA:TELEcom:SONet:ASCan?

Returns (each of one or more rows): <numeric>{,<numeric>}

The results returned are those for the last FULL scan. Results from partial scans are not available. If no full scan has been completed since the instrument was powered up, this command will return -1.

If data is available it is returned as a set of string arrays one for each scanned group. The arrays are separated by a CR/LF pair. A group is defined as a set of scanned paths at either the SPE or VT level. The arrays consist of comma separated numerics, one for each path scanned. The value of the numeric indicates the status of the scanned path. The following values are valid.

SONET Command Reference

FETCh subsystem

Value	State
0	No Problems Detected
1	Alarms or Errors Detected
2	Path Unequipped
3	Loss of Pointer
4	AIS
5	RDI
6	H4 Multiframe Loss
?	Invalid

For a specific signal structure, the format of the returned strings are shown below:

a) STS-3 STS-1 VT-6

This signal consists of 3 STS-1s each of which contains 7 VT-Groups. The VT-Groups's in turn each contain 1 VT-6. From the perspective of the Alarm Scan function the paths are 3 at the STS-1 level and 21 at the VT level. The STS-1 paths are defined as a group on their own while the 21 VTs are arranged as 3 groups of 7 paths with the groups corresponding to the STS-1 allocation. For this configuration, four arrays are returned with fomats shown below:

```
STS-3      -> STS1#1, STS1#2, STS1#3
STS-1 #1   -> VT#1,VT#2,VT#3,VT#4,VT#5,VT#6,VT#7
STS-1 #2   -> VT#1,VT#2,VT#3,VT#4,VT#5,VT#6,VT#7
STS-1 #3   -> VT#1,VT#2,VT#3,VT#4,VT#5,VT#6,VT#7
```

For Example, the output could look like:

```
0,1,1
1,1,1,0,0,1,0
2,2,2,2,2,2,2
0,0,0,0,1,0,0
```

b) STS-3 STS-1 Full SPE

This signal consists of 3 STS-1s each containing 1 Full SPE. In this configuration there are 3 paths, 3 at the STS-1 level and no lower paths. For this configuration, 3 arrays are returned with the following format:

SONET Command Reference

FETCh subsystem

```
STS-1      -> STS-1
VT-Group   -> [1-1],[1-2],[1-3],[2-1],[2-2],[2-3],[3-1],
              [3-2],[3-3],[4-1],[4-2],[4-3],[5-1],[5-2],
              [5-3],[6-1],[6-2],[6-3],[7-1],[7-2],[7-3]
```

The output will look like:

```
0
1,1,1,0,0,0,0,1,1,1,1,1,1,1,0,0,2,0,0,0,0
```

g) STS-1 VT-1.5

This signal again comprises 1 STS-1 containing 7 VT Group's. However, this time the VT Group's each contain 4 VT-1.5's. As before, the STS-1 path is defined as a group on its own, while the 7 VT-1.5 paths are also defined as one group. For this configuration, 2 groups are returned with the following format:

NOTE: VT-1.5's designated thus [VT-Group# - VT-1.5#]

```
STS-1      -> STS-1
VT-Group   -> [1-1],[1-2],[1-3],[1-4],[2-1],[2-2],[2-
              3],[2-4],[3-1],[3-2],[3-3],[3-4],[4-1],[4-2],[4-3],[4-
              4],[5-1],[5-2],[5-3],[5-4],[6-1],[6-2],[6-3],[6-4],[7-
              1],[7-2],[7-3],[7-4]
```

The output will look like:

```
0
1,1,1,1,0,0,0,0,1,1,1,1,1,1,1,1,1,0,0,0,2,0,0,0,0,0,1
```

h) Unrecognized Structure

When Alarm Scan is operating in AUTO mode, it is possible that due to various signal alarm conditions, it may not be able to determine the structure for a particular group of paths. When this occurs that group is marked as an "Unrecognized Structure". The string returned for such a group is the SCPI NAN - "9.91E+37"

:FETCh:ARRAy:DATA:TELEcom:SONet:TSCan?

Returns (each of one or <numeric>{,<numeric>
more rows):

The results returned are those for the last FULL scan. Results from partial scans are not available. If no full scan has been completed since the instrument was powered up, this command will return -1.

SONET Command Reference

FETCh subsystem

If data is available it is returned as a set of string arrays one for each scanned group. The arrays are separated by a CR/LF pair. A group is defined as a set of scanned paths at either the STS or VT level. The arrays consist of comma separated numerics, one for each tributary scanned. The value of the numeric indicates the status of the scanned tributary. The following values are valid.

Value	State
0	No Problems Detected
1	Alarms or Errors Detected

For a specific signal structure, the format of the returned strings are shown below:

a) STS-1 VT-6

This signal consists of 1 STS-1 containing 7 VT-Groups's. Each VT-Group contains 1 VT-6. There are therefore 7 tributaries to be scanned. These are defined as one group and hence for this configuration, 1 array is returned with the following format:

STS-1 -> VT6#1, VT6#2, VT6#3, VT6#4, VT6#5, VT6#6, VT6#7

The output will look like:

1,1,1,0,0,0,0

b) STS-1 VT-2

This signal again comprises 1 STS-1 containing 7 VT-Group's. However, this time the VT-Group's each contain 3 VT-2's. There are therefore 21 (7*3) tributaries to be scanned. These are defined as one group and are returned in the following format:

NOTE: VT-2's designated thus [VT-Group# - VT-2#]

STS-1 -> [1-1],[1-2],[1-3],[2-1],[2-2],[2-3],[3-1],
[3-2],[3-3],[4-1],[4-2],[4-3],[5-1],[5-2],
[5-3],[6-1],[6-2],[6-3],[7-1],[7-2],[7-3]

The output will look like:

1,1,1,0,0,0,0,1,1,1,1,1,1,1,0,0,1,0,0,0,0

SONET Command Reference

FETCh subsystem

c) STS-1 VT-1.5

This signal again comprises 1 STS-1 containing 7 VT-Groups's. However, this time the VT-Group's each contain 4 VT-1.5's. There are therefore 28 (7*4) tributaries to be scanned. These are defined as one group and are returned in the following format:

NOTE: VT-1.5's designated thus [VT-Group# - VT-1.5#]

```
STS-1      -> [1-1],[1-2],[1-3],[1-4],[2-1],[2-2],[2-3],[2-4],[3-1],[3-2],[3-3],[3-4],[4-1],[4-2],[4-3],[4-4],[5-1],[5-2],[5-3],[5-4],[6-1],[6-2],[6-3],[6-4],[7-1],[7-2],[7-3],[7-4]
```

The output will look like:

```
1,1,1,0,0,0,0,1,1,1,1,1,1,1,0,0,1,0,0,0,0
```

2) STS-12/OC-12

For the STS-12/OC-12 situation, the formats are similar to those defined above for STS-1/STS-3 except that there will be data returned for all four STS-3's in the signal.

Consider a STS-12 signal with a STS-3C structure. In the STS-3 case this structure would not be considered since there is only one tributary in the signal. However in the STS-12/OC-12 case there are 4 tributaries and the scan is carried out.

In this case each STS-3C is treated as a separate group, hence 4 arrays are returned from the SCPI command:

```
STS-3 #1 STS-3C
STS-3 #2 STS-3C
STS-3 #3 STS-3C
STS-3 #4 STS-3C
```

The output will look like:

```
0
0
1
1
```

:FETCh:ARRay:DATA:TELEcom:SONet:PGRaph?

```
Returns:          <numeric>,<numeric>, <numeric>,
                  ...
                  <numeric>,<numeric>, <numeric>
```

SONET Command Reference

FETCh subsystem

Option A3R only. Returns an array of 576 bytes, 2 bytes for each of the possible 288 points on the displayed pointer graph. The 2 bytes at each point indicate the maximum and minimum offset at that point. Each byte has 3 numeric entries separated by commas.

The value of the 3 numeric entries, <range bit>,<validity bit>,<offset value>, provide the following information:

Range bit	Validity Bit	Offset Value	Description
1	1	-18 to +18	Valid in range result
1	0	0	No measurement
1	1	9.91E+37	Alarms during measurement
2	1	0	Offset out of range > +18
0	1	0	Offset out of range < -18

The graph entries are arranged as shown below. Each entry has the format previously described above:

```
<max offset 1>,<min offset 1>,<max offset 2>,<min offset 2>,  
<max offset 3>,<min offset 3>,<max offset 4>,<min offset 4>,  
<max offset 5>,<min offset 5>,<max offset 6>,<min offset 6>,  
.....  
.....  
<max offset 287>,<min offset 287>,<max offset 288>,<min offset 288>
```

Range of valid offset values is -18 thru +18

A typical return array might look like:

```
1,1,9.91E+37,1,1,9.91E+37,1,1, 0,1,1, 0,1,1, +1,1,1, -2, etc....
```

:FETCh:ARRAy:DATA:TELEcom:SONet:OCAPture? <numeric>

<numeric =	1 to 8	D4D12 and A1A2
	1 to 16	All other Overhead Channels

Returns (each of one or more rows): <string>,<numeric> ,

(last row): <string>,<numeric>

Returns an array with the number of entries determined by <numeric> and separated by CR/LF.

SONET Command Reference

FETCh subsystem

Each entry consists of an alphanumeric string and a numeric separated by commas. The alphanumeric string provide the hexadecimal value of the captured data. The length of the string depends upon the overhead channel selected for capture, two hexadecimal characters/overhead byte. The numeric indicates the number of frames for which the captured data existed. If this command is issued when a capture is being performed, some entries will contain no data. In this case 9.91E+37 is returned.

The overhead byte or bytes to be captured is specified by :SENS:DATA:TEL:OCAP:CHAN <channel>.

:FETCh:ARRay:DATA:TELEcom:SONet:POVerhead? <numeric>

<numeric> = 1 to 9

Returns the value of the selected path overhead bytes as an array of strings. Each string is in the range "00000000" to "11111111". This is a snapshot of the overhead byte and is captured once per second.

The array always begins with byte 1 of the path overhead and ends with the byte number specified by <numeric>.

Byte Order: (1) J1 (2) B3 (3) C2 (4) G1 (5) F2 (6) H4 (7) Z3 (8) Z4 (9) N1.

Returns: <string>{,<string>}

:FETCh:ARRay:DATA:TELEcom:SONet:OVERhead? <numeric><numeric><numeric>

<numeric> = 1 to 27 (Byte Number)
(first parameter)

<numeric> = 1 to 4 (STS-3 number)
(second parameter)

<numeric> = 1 to 3 (STS-1 number)
(third parameter)

Returns the value of the selected transport overhead bytes as an array of strings. Each string is in the range "00000000" to "11111111". This is a snapshot of the overhead byte and is captured once per second.

The array always begins with byte 1 of the transport overhead and ends with the byte number specified by the first parameter.

SONET Command Reference

FETCh subsystem

Number	Name	Number	Name	Number	Name
1	A1	10	H1	19	D7
2	A2	11	H2	20	D8
3	J0/Z0	12	H3	21	D9
4	B1	13	B2	22	D10
5	E1	14	K1	23	D11
6	F1	15	K2	24	D12
7	D1	16	D4	25	S1/Z1
8	D2	17	D5	26	M0/M1/Z2
9	D3	18	D6	27	E2

Returns (each of one or more rows): <string>,{<string>}

ATM SCPI Command Reference

OUTPut subsystem, see page 6-4.

SOURce subsystem- Transmitter ATM Commands, see page 6-6.

INPut subsystem, see page 6-20.

SENSe subsystem - Receiver ATM Settings, see page 6-22.

SENSe subsystem - Result Returning Commands, see page 6- 30.

FETCh subsystem, see page 6-36.

ATM Command Reference

ATM Command Reference

This chapter contains detailed information on the SCPI (Standard Commands for Programming Instruments) and IEEE 488.2 common commands you will use when writing programs to control your HP 37717C for ATM operation.

Please also refer to chapter 2 Common Commands for general information on SCPI command formats and for a list of commands that are common to PDH, SDH, SONET, ATM or Jitter operation; they are as follows:

SCPI Command Format

Remote Control Commands

Instrument Options

INSTRument subsystem

SOURce subsystem

SOURce subsystem - Transmitter Common Commands

INPut subsystem

SENSe subsystem

SENSe subsystem - Receiver Common Commands

SENSe subsystem - Test Timing

SENSe subsystem - Analysis Control

SENSe subsystem - Trouble Scan Results

SENSe subsystem - Configuring Graphics

SENSe subsystem - Managing Graphics Stores

SENSe subsystem - Retrieving Graphics Store Data

SENSe subsystem - Retrieving Data for a Single Graph

SENSe subsystem - Obtaining Graphics End of Measurement Results

STATus Subsystem

SYSTem Subsystem

IEEE common capabilities

OUTPut subsystem

OUTPut subsystem

This subsystem controls the characteristics of the instrument's output ports.

:OUTPut:DATA:TELEcom:ATM:RATE <discrete>

<discrete> =	OPT4	STM-4 Optical
	OPT1	STM-1 Optical
	SDH	STM-1 Electrical
	M140	140 Mb/s PDH
	M34	34 Mb/s PDH
	M2	2 Mb/s PDH

Selects the ATM signal rate.

The corresponding query returns the ATM signal rate in discrete form as listed above.

:OUTPut:DATA:TELEcom:ATM:RATE?

Returns : <discrete>

:OUTPut:TELEcom:ATM:CODE <discrete>

<discrete> =	AMI	2 Mb/s
	HDB3	34 Mb/s, 2 Mb/s
	CMI	140 Mb/s

Selects the interface line code for the ATM transmitter.

The corresponding query returns the ATM line code in discrete form as listed above.

ATM Command Reference

OUTPut subsystem

:OUTPut:TELEcom:ATM:CODE?

Returns : <discrete>

:OUTPut:TELEcom:ATM:BALance <discrete>

<discrete> =	UNBalanced	75 Ω Unbalanced
	BALanced	120 Ω Balanced

Selects the ATM transmitter termination level. 120 Ω Balanced is only allowed when :OUTPut:DATA:TELEcom:ATM:RATE <discrete> is set to M2.

The corresponding query returns the ATM termination in discrete form as listed above.

:OUTPut:TELEcom:ATM:BALance?

Returns : <discrete>

SOURce subsystem- Transmitter ATM Commands

SOURce subsystem- Transmitter ATM Commands

:SOURce:DATA:TELEcom:ATM:M2:CRC4 <boolean>

<boolean> =	0 or OFF	CRC4 Multiframe off
	1 or ON	CRC4 Multiframe on

Enable/Disable CRC4 multiframe. Only valid when
:OUTPut:DATA:TELEcom:ATM:RATE <discrete> is set to M2 .

The corresponding query returns the CRC4 multiframe state as 0 or 1.

:SOURce:DATA:TELEcom:ATM:M2:CRC4?

Returns :	<numeric>	0 or 1
-----------	-----------	--------

:SOURce:DATA:TELEcom:ATM:CBWidth <string>

<string> =	"<numeric>"	100 to Max in cells per second
	"MAX"	Maximum bandwidth
	"MIN"	Minimum bandwidth
	"UP"	Increase bandwidth in 1 c/s steps
	"DOWN"	Decrease bandwidth in 1 c/s steps

Sets the foreground cell stream bandwidth. The Maximum Available bandwidth is the sum of the Foreground channel bandwidth, the Background channels bandwidth, and the Fill bandwidth and is dependent on the selection made under
:OUTPut:DATA:TELEcom:ATM:RATE <discrete>

- M2 (2 Mb/s) - 4528 cells/s
- M34 (34Mb/s) - 80,000 cells/s
- M140 (140 Mb/s) - 326,037 cells/s
- SDH or OPT1 or OPT4 (155 Mb/s) - 353,207 cells/s

MAX sets the foreground bandwidth to the (Maximum Available bandwidth – all Background bandwidth and the Fill bandwidth).

SOURce subsystem- Transmitter ATM Commands

The corresponding query returns the foreground cell stream bandwidth as detailed below.

:SOURce:DATA:TELEcom:ATM:CBWidth? <string>

<string> =	"PCT" or "%"	% Cells per second
	"C/S"	Cells per second
	"B/S"	Bits per second

Returns : <string>

If no suffix is specified, the value is returned in cells per second.

:SOURce:DATA:TELEcom:ATM:BACKground:CBWidth<numeric>,<string>

<numeric> =	1 to 3	B/G channel number
<string> =	"0%" to "100%"	
	"MAX"	Maximum bandwidth
	"MIN"	Minimum bandwidth
	"UP"	Increase bandwidth in 1% steps
	"DOWN"	Decrease bandwidth in 1% steps

Sets the background channel cell stream bandwidth as a percentage . The Maximum Available bandwidth is the sum of the Foreground channel bandwidth, the remaining Background channels bandwidth, and the Fill bandwidth and is dependent on the selection made under :OUTPut:DATA:TELEcom:ATM:RATE <discrete>

- M2 (2 Mb/s) - 4528 cells/s
- M34 (34Mb/s) - 80,000 cells/s
- M140 (140 Mb/s) - 326,037 cells/s
- SDH or OPT1 or OPT4 (155 Mb/s) - 353,207 cells/s

MAX sets the background bandwidth to the Maximum Available bandwidth – Foreground bandwidth, the other Background bandwidth and the Fill bandwidth.

The corresponding query returns the background cell stream bandwidth as detailed below.

SOURce subsystem- Transmitter ATM Commands

:SOURce:DATA:TELEcom:ATM:BACKground:CBWidth? <numeric>, <string>

<numeric> =	1 to 3	B/G channel number
<string>=	"PCT" or "%"	% Cells per second
	"C/S"	Cells per second
	"B/S"	Bits per second

Returns : <string>

If no suffix is specified, the value is returned in % Cells per second.

:SOURce:DATA:TELEcom:ATM:FILL:CBWidth? <string>

<string>=	"PCT" or "%"	% Cells per second
	"C/S"	Cells per second
	"B/S"	Bits per second

Returns : <string>

Returns the fill channel cell stream bandwidth. This value is the bandwidth that remains after the foreground and background cell streams have been allocated. If no suffix is specified, the value is returned in % Cells per second.

:SOURce:DATA:TELEcom:ATM:DISTRibution <discrete>

<discrete> =	BURSt	Repetitive burst
	PERiodic	Single burst, user triggered

Sets the foreground cell stream distribution type.

The corresponding query returns the cell stream distribution type in discrete form as listed above.

:SOURce:DATA:TELEcom:ATM:DISTRibution?

Returns : <discrete>

SOURce subsystem- Transmitter ATM Commands

:SOURce:DATA:TELEcom:ATM:DISTRibution:BSIZE <numeric>

<numeric> = 1 to 2047 cells

When :SOUR:DATA:TEL:ATM:DIST BURS is selected, sets the size of the repetitive burst transmitted at intervals determined by the selected cell rate.

When :SOURce:DATA:TELEcom:ATM:DISTRibution <discrete> is set to PER, sets the size of the single burst transmitted, when triggered by the user.

The corresponding query returns the foreground cell stream burst size in numeric form.

:SOURce:DATA:TELEcom:ATM:DISTRibution:BSIZE?

Returns : <numeric> 1 to 2047

:SOURce:DATA:TELEcom:ATM:DISTRibution:BURSt <discrete>

<discrete> = NONE
ONCE

Triggers a single burst of cells in the foreground cell stream when :SOURce:DATA:TELEcom:ATM:DISTRibution <discrete> is set to PER .

The corresponding query always returns NONE.

:SOURce:DATA:TELEcom:ATM:DISTRibution:BURSt?

Returns : NONE

:SOURce:DATA:TELEcom:ATM:NINTerface <discrete>

<discrete>= UNI User to Network Interface
NNI Network to Network Interface

Selects the ATM Layer network interface.

The corresponding query returns the ATM layer network interface in discrete form as listed above.

SOURce subsystem- Transmitter ATM Commands

:SOURce:DATA:TELEcom:ATM:NINTerface?

Returns : <discrete>

:SOURce:DATA:TELEcom:ATM:HEADer:GFC <numeric>

<numeric> = 0 to 15 Generic Flow Control Header

Sets the foreground cell header field, Generic Flow Control. The GFC is only valid if :SOURce:DATA:TELEcom:ATM:NINTerface <discrete> is set to UNI.

The corresponding query returns the foreground cell header, Generic Flow Control, in numeric form.

:SOURce:DATA:TELEcom:ATM:HEADer:GFC?

Returns : <numeric> 0 to 15

:SOURce:DATA:TELEcom:ATM:HEADer:VPI <numeric>

<numeric> = 0 to 255 UNI mode
0 to 4095 NNI mode

Sets the foreground cell header field, Virtual Path Identifier.

The corresponding query returns the foreground cell header, Virtual Path Identifier in numeric form.

:SOURce:DATA:TELEcom:ATM:HEADer:VPI?

Returns : <numeric> numeric

:SOURce:DATA:TELEcom:ATM:HEADer:VCI <numeric>

<numeric> = 32 to 65535

Sets the foreground cell header field, Virtual Channel Identifier.

The corresponding query returns the foreground cell header, Virtual Channel Identifier in numeric form.

SOURce subsystem- Transmitter ATM Commands

The corresponding query returns the foreground cell payload type in discrete form as listed above.

:SOURce:DATA:TELEcom:ATM:PAYLoad?

Returns : <discrete>

:SOURce:DATA:TELEcom:ATM:PAYLoad:PATtern <discrete>

<discrete> =	PRBS15	$2^{15}-1$ PRBS
	PRBS23	$2^{23}-1$ PRBS

Selects the foreground Cross Cell payload pattern if

:SOURce:DATA:TELEcom:ATM:PAYLoad <discrete> is set to CCELL .

The corresponding query returns the foreground Cross Cell payload pattern in discrete form as listed above.

:SOURce:DATA:TELEcom:ATM:PAYLoad:PATtern?

Returns : <discrete>

:SOURce:DATA:TELEcom:ATM:PAYLoad:UWORD <string>

When :SOURce:DATA:TELEcom:ATM:PAYLoad <discrete> is set to USER, sets the user word pattern in the range "00000000" to "11111111".

The corresponding query returns the user word pattern as a string.

:SOURce:DATA:TELEcom:ATM:PAYLoad:UWORD?

Returns : <string>

:SOURce:DATA:TELEcom:ATM:BACKground:HEADer:GFC <numeric>, <numeric>

<numeric> = (first parameter)	1 to 3	Background channel No.
----------------------------------	--------	------------------------

<numeric> = (second parameter)	0 to 15	Generic Flow Control Header
-----------------------------------	---------	-----------------------------

SOURce subsystem- Transmitter ATM Commands

Sets the specified background cell header field, Generic Flow Control. The GFC is only valid if :SOURce:DATA:TELEcom:ATM:NINterface <discrete> is set to UNI.

The corresponding query returns the background cell header, Generic Flow Control in numeric form.

:SOURce:DATA:TELEcom:ATM:BACKground:HEADer:GFC? <numeric>

<numeric> = 1 to 3 Background channel No.

Returns : <numeric> Generic Flow Control Header

:SOURce:DATA:TELEcom:ATM:BACKground:HEADer:VPI <numeric>, <numeric>

<numeric> = 1 to 3 Background channel No.
(first parameter)

<numeric> = 0 to 255 UNI mode VPI
(second parameter)

0 to 4095 NNI mode VPI

Sets the specified background cell header field, Virtual Path Identifier.

The corresponding query returns the background cell header, Virtual Path Identifier in numeric form.

:SOURce:DATA:TELEcom:ATM:BACKground:HEADer:VPI? <numeric>

<numeric> = 1 to 3 Background channel No.

Returns : <numeric> Virtual path identifier

:SOURce:DATA:TELEcom:ATM:BACKground:HEADer:VCI <numeric>, <numeric>

<numeric> = 1 to 3 Background channel No.
(first parameter)

<numeric> = 32 to 65535 Virtual channel identifier
(second parameter)

Sets the specified background cell header field, Virtual Channel Identifier.

SOURce subsystem- Transmitter ATM Commands

The corresponding query returns the background cell header, Virtual Channel Identifier in numeric form.

:SOURce:DATA:TELEcom:ATM:BACKground:HEADer:VCI? <numeric>

Returns : <numeric> 32 to 65535

:SOURce:DATA:TELEcom:ATM:BACKground:HEADer:PTI <numeric>, <string>

<numeric> =	1 to 3	Background channel No.
<string> =	"000"	No Congestion
	"010"	Congestion

Sets the specified background cell header field, Payload Type.

The corresponding query returns the background cell header, Payload Type as a string.

:SOURce:DATA:TELEcom:ATM:BACKground:HEADer:PTI? <numeric>

Returns : <numeric>

:SOURce:DATA:TELEcom:ATM:BACKground:HEADer:CLP <numeric>, <string>

<numeric> =	1 to 3	Background channel No.
<string> =	"0"	High Priority
	"1"	Low Priority

Sets the specified background cell header field, Cell Loss Priority bit.

The corresponding query returns the background cell header, Cell Loss Priority bit as a string.

:SOURce:DATA:TELEcom:ATM:BACKground:HEADer:CLP? <numeric>

Returns : <string>

SOURce subsystem- Transmitter ATM Commands

**:SOURce:DATA:TELEcom:ATM:BACKground:PAYLoad:UWORD
<numeric>, <string>**

<numeric> = 1 to 3 Background channel No.

Sets the specified background cell payload user word pattern in the range "00000000" to "11111111".

The corresponding query returns the word pattern as a string.

**:SOURce:DATA:TELEcom:ATM:BACKground:PAYLoad:UWORD?
<numeric>**

Returns : <string>

:SOURce:DATA:TELEcom:ATM:FILL <discrete>

<discrete> = IDLE
UNASsigned

Sets the type of cells used to fill surplus bandwidth. If the sum of the specified bandwidth for foreground and background channels does not equal the maximum bandwidth available, the surplus bandwidth must be filled with some kind of cell.

The corresponding query returns the type of cells used to fill surplus bandwidth in discrete form as described above.

:SOURce:DATA:TELEcom:ATM:FILL?

Returns : <discrete>

:SOURce:DATA:TELEcom:ATM:ERRor:TYPE <discrete>

<discrete> = SHEC Single HEC
DHEC Double HEC
BIT
TCMisinsert T cell misinsert
OAMCrc CRC OAM
REI or FEBE

SOURce subsystem- Transmitter ATM Commands

BIP

REBE

CRC4

Selects the transmitter ATM error type. Only valid if :SOURce:DATA:TELEcom:TFUNction <discrete> is set to ATM.

Errors are added to the selected cell stream. Bit, Single (correctable) or Double (non-correctable) error events can be added.

The corresponding query returns the ATM error type in discrete form as listed above.

:SOURce:DATA:TELEcom:ATM:ERRor:TYPE?

Returns : <discrete>

:SOURce:DATA:TELEcom:ATM:ERRor:STReam <discrete>

<discrete> = FG Foreground error rate
 ALL SHEC or DHEC Burst size

Selects the ATM transmitter error stream type.

All is valid for HEC error types only. If the stream type is selected as FG (foreground) then a rate will be selected and if the stream type is selected as ALL then a burst size and add burst selection is required. Therefore a further selection of :SOURce:DATA:TELEcom:ATM:ERRor:RATE <discrete> is required. If ALL is selected, further selections of :SOURce:DATA:TELEcom:ATM:ERRor:BSIZE <numeric> and :SOURce:DATA:TELEcom:ATM:ERRor:BURSt <discrete>, state = ABUR are required.

The corresponding query returns the ATM error stream type in discrete form as listed above.

:SOURce:DATA:TELEcom:ATM:ERRor:STReam?

Returns : <discrete>

SOURce subsystem- Transmitter ATM Commands

:SOURce:DATA:TELEcom:ATM:ERRor:RATE <discrete>

<discrete> =	NONE	No error add
	ONCE	Single error add
	E_3	1 in 1000 error add

Sets the transmitter ATM error rate. Only valid if

:SOURce:DATA:TELEcom:TFUNction <discrete> is set to ATM and

:SOURce:DATA:TELEcom:ATM:ERRor:STReam <discrete> is set to FG. Errors are added to the foreground cell stream. Bit, Single (correctable) or Double (non-correctable) error events can be added

The corresponding query returns the ATM error rate in discrete form as shown above.

:SOURce:DATA:TELEcom:ATM:ERRor:RATE?

Returns : <discrete>

:SOURce:DATA:TELEcom:ATM:ERRor:BSIZE <numeric>

<numeric> = 1 to 8 Number of cells

Selects the ATM transmitter error burst size. Only valid if

:SOURce:DATA:TELEcom:TFUNction <discrete> is set to ATM and

:SOURce:DATA:TELEcom:ATM:ERRor:STReam <discrete> is set to ALL. To transmit the burst further selection of

:SOURce:DATA:TELEcom:ATM:ERRor:BURSt <discrete>, state = ABUR is required.

The corresponding query returns the ATM error burst size in numeric form as listed above.

:SOURce:DATA:TELEcom:ATM:ERRor:BSIZE?

Returns : <numeric>

:SOURce:DATA:TELEcom:ATM:ERRor:BURSt <discrete>

<discrete> =	OFF	Burst off
	ABURst	Transmit error burst

SOURce subsystem- Transmitter ATM Commands

Enables/Disables an ATM error burst. Only valid if

:SOURce:DATA:TELEcom:TFUNction <discrete> is set to ATM and

:SOURce:DATA:TELEcom:ATM:ERRor:STReam <discrete> is set to ALL. and

:SOURce:DATA:TELEcom:ATM:ERRor:BSIZE <numeric>.

The corresponding query returns the ATM error burst state in discrete form as listed above.

:SOURce:DATA:TELEcom:ATM:ERRor:BURSt?

Returns : <discrete>

:SOURce:DATA:TELEcom:ATM:ALARm <discrete>

<discrete> =	NONE	No Alarms
	VPAis	Virtual Path AIS
	VPRDi or VPFerf	Virtual Path FERF
	VPCC	Virtual Path Continuity Check
	VCAis	Virtual Channel AIS
	VCRDi or VCFerf	Virtual Channel FERF
	VCCC	Virtual Channel Continuity Check
	AIS	
	FRAME	
	RDI or FERF	
	RAI	

Selects the ATM alarm to be added to the transmitted signal. Only valid if

:SOURce:DATA:TELEcom:TFUNction <discrete> is set to ATM. The

corresponding query returns the selected ATM alarm in discrete form as listed above.

:SOURce:DATA:TELEcom:ATM:ALARm?

Returns : <discrete>

SOURce subsystem- Transmitter ATM Commands

:SOURce:DATA:TELEcom:ATM:THRumode <boolean>

<boolean> =	0 or OFF
	1 or ON

This command sets thru mode at the ATM Layer.

The corresponding query returns the thru mode state as 0 or 1.

:SOURce:DATA:TELEcom:ATM:THRumode?

Returns :	<numeric>	0 or 1
-----------	-----------	--------

:SOURce:DATA:TELEcom:ATM:TTRace:PATtern <discrete>

<discrete> =	TEST	"HP37717C"
	USER	User defined

Selects the type of Trail Trace string to be transmitted. TEST contains the message "HP37717C" with an added CRC7 byte. USER allows user selection of a message containing 15 ASCII characters with an added CRC7 byte. Is only valid if :OUTPut:DATA:TELEcom:ATM:RATE <discrete> is set to M34 or M140.

The corresponding query returns the type of trail trace in discrete form as listed above.

:SOURce:DATA:TELEcom:ATM:TTRace:PATtern?

Returns :	<discrete>
-----------	------------

:SOURce:DATA:TELEcom:ATM:TTRace:DATA <string>

Sets the user defined pattern that is to be transmitted in the Trail Trace string. The string can be up to 15 ASCII characters in length. If less than 15 characters are input, the instrument will pad with the required number of NULL characters. If the string contains any non printing characters, ~ is substituted.

The corresponding query returns the type of trail trace as a string.

:SOURce:DATA:TELEcom:ATM:TTRace:DATA?

Returns :	<string>
-----------	----------

INPut subsystem

INPut subsystem

This subsystem controls the characteristics of the instrument's input ports.

:INPut:TELEcom:ATM:RATE <discrete>

<discrete> =	OPT4	STM-4 Optical
	OPT1	STM-1 Optical
	SDH	STM-1 Electrical
	M140	140 Mb/s
	M34	34 Mb/s
	M2	2 Mb/s

Selects the ATM signal type.

The corresponding query returns the ATM signal type in discrete form as listed above.

:INPut:TELEcom:ATM:RATE?

Returns : <discrete>

:INPut:TELEcom:ATM:CODE <discrete>

<code> =	AMI	2 Mb/s
	HDB3	34 Mb/s, 2 Mb/s
	CMI	140 Mb/s, STM-1, STM-4

Selects the line code interface for the ATM receiver.

The corresponding query returns the line code in discrete form, as listed above.

:INPut:TELEcom:ATM:CODE?

Returns : <discrete>

SENSe subsystem - Receiver ATM Settings

SENSe subsystem - Receiver ATM Settings

ATM Layer

:SENSe:DATA:TELEcom:ATM:M2:CRC4 <boolean>

<boolean> =	0 or OFF	CRC4 Multiframe off
	1 or ON	CRC4 Multiframe on

Enable/Disable CRC4 multiframe. Only valid when :INP:TEL:ATM:RATE M2 is selected.

The corresponding query returns the CRC4 multiframe state as 0 or 1.

:SENSe:DATA:TELEcom:ATM:M2:CRC4?

Returns : <boolean> 0 or 1

:SENSe:DATA:TELEcom:ATM:SELEct <discrete>

<discrete> =	AUSer	All User
	VPValue	Virtual Path value
	VCValue	Virtual Channel value
	IDLE	
	UNASsigned	
	EXPErtmode	User Defined

Selects the cells selected for test.

The corresponding query returns the cells selected for test in discrete form as listed above.

:SENSe:DATA:TELEcom:ATM:SELEct?

Returns : <discrete>

ATM Command Reference

SENSe subsystem - Receiver ATM Settings

:SENSe:DATA:TELEcom:ATM:NINTerface <discrete>

<discrete> =	UNI	User to Network Interface
	NNI	Network to Network Interface

Selects the ATM Layer Interface.

The corresponding query returns the ATM Layer Interface in discrete form as listed above.

:SENSe:DATA:TELEcom:ATM:NINTerface?

Returns : <discrete>

:SENSe:DATA:TELEcom:ATM:HEADer:GFC <discrete>

<discrete> =	X	Dont Care
	SELEct	User Defined

Sets the Cell Header GFC. SEL is only valid when

:SENSe:DATA:TELEcom:ATM:SELEct <discrete> is set to EXP.

The corresponding query returns the Cell Header GFC, in discrete form as listed above.

:SENSe:DATA:TELEcom:ATM:HEADer:GFC?

Returns : <discrete>

:SENSe:DATA:TELEcom:ATM:HEADer:SGFC <numeric>

<numeric> = 0 to 15

Sets the user defined Cell Header GFC value when

:SENSe:DATA:TELEcom:ATM:HEADer:GFC <discrete> is set to SEL.

The corresponding query returns the user defined Cell Header, GFC value in numeric form.

:SENSe:DATA:TELEcom:ATM:HEADer:SGFC?

Returns : <numeric> 0 to 15

ATM Command Reference

SENSe subsystem - Receiver ATM Settings

:SENSe:DATA:TELEcom:ATM:HEADer:VPI <discrete>

<discrete> =	X	Dont Care
	SEL	User Defined

Sets the Cell Header VPI. X is only valid when

:SENSe:DATA:TELEcom:ATM:SElect <discrete> is set to EXP.

The corresponding query returns the Cell Header, VPI in discrete form as listed above.

:SENSe:DATA:TELEcom:ATM:HEADer:VPI?

Returns : <discrete>

:SENSe:DATA:TELEcom:ATM:HEADer:SVPI <numeric>

<numeric> =	0 to 255	UNI
	0 to 4095	NNI

Sets the user defined Cell Header VPI value when

:SENSe:DATA:TELEcom:ATM:HEADer:VPI <discrete> is set to SEL.

The corresponding query returns the user defined Cell Header, VPI value in numeric form.

:SENSe:DATA:TELEcom:ATM:HEADer:SVPI?

Returns : <numeric>

:SENSe:DATA:TELEcom:ATM:HEADer:VCI <discrete>

<discrete> =	SElect	User Defined
	USER	Filters VCI's of 1, 2, 5 or >15

Sets the Cell Header VCI. USER is only valid when

:SENSe:DATA:TELEcom:ATM:SElect <discrete> is set to EXP.

The corresponding query returns the Cell Header VCI in discrete form as listed above.

ATM Command Reference
SENSe subsystem - Receiver ATM Settings

:SENSe:DATA:TELEcom:ATM:HEADer:VCI?

Returns : <discrete>

:SENSe:DATA:TELEcom:ATM:HEADer:SVCI <numeric>

<numeric> =	0 to 65535	EXPertmode
	32 to 65535	VCValue

Sets the user defined Cell Header VCI value when
::SENSe:DATA:TELEcom:ATM:HEADer:VCI <discrete> is set to SEL.

The corresponding query returns the user defined Cell Header VCI, value in numeric form.

:SENSe:DATA:TELEcom:ATM:HEADer:SVCI?

Returns : <numeric>

:SENSe:DATA:TELEcom:ATM:HEADer:PTI <string>

<string> =	"nnn"	n = 0,1 or X
------------	-------	--------------

Sets the Cell Header, PTI.

The corresponding query returns the Cell Header, PTI as a string.

:SENSe:DATA:TELEcom:ATM:HEADer:PTI?

Returns : <string>

:SENSe:DATA:TELEcom:ATM:HEADer:CLP <discrete>

<discrete> =	ZERO	0
	ONE	1
	X	Don't Care

Sets the Cell Header, CLP.

The corresponding query returns the CLP Cell Header in discrete form as listed above.

SENSe subsystem - Receiver ATM Settings

:SENSe:DATA:TELEcom:ATM:HEADer:CLP?

Returns : <discrete>

:SENSe:DATA:TELEcom:ATM:PAYLoad <discrete>

<discrete> =	CCELI	Cross Cell, $2^{15}-1$ or $2^{23}-1$ PRBS
	SCELI	Single Cell, 2^9-1 PRBS
	USER	8 bit User Word
	TCELI	Test Cell
	LIVE	Live Traffic

Sets the Cell Payload Type.

The corresponding query returns the Cell Payload type in discrete form as listed above.

:SENSe:DATA:TELEcom:ATM:PAYLoad?

Returns : <discrete>

If :SENSe:DATA:TELEcom:ATM:MMODE is set to ISERvice then LIVE is returned.

:SENSe:DATA:TELEcom:ATM:PAYLoad:PATtern <discrete>

<discrete> =	PRBS15	$2^{15}-1$ PRBS
	PRBS23	$2^{23}-1$ PRBS

Sets the Cross Cell Payload pattern when :SENSe:DATA:TELEcom:ATM:PAYLoad <discrete> is set to CCEL.

The corresponding query returns the Cross Cell Payload pattern in discrete form as listed above.

:SENSe:DATA:TELEcom:ATM:PAYLoad:PATtern?

Returns : <discrete>

SENSe subsystem - Receiver ATM Settings

:SENSe:DATA:TELEcom:ATM:PAYLoad:UWORD <string>

Sets the Cell Payload user defined word pattern in the range "00000000" to "11111111" when :SENS:DATA:TEL:ATM:PAYL USER is selected.

The corresponding query returns the word pattern as a string.

:SENSe:DATA:TELEcom:ATM:PAYLoad:UWORD?

Returns : <string>

:SENSe:DATA:TELEcom:ATM:CDV:PCRate <discrete>

<discrete> = USER User defined
AVERAge Last gated average Rx'ed cell rate

Selects the Cell Delay Variation, Peak Cell Rate type. If USER is selected, further selection of :SENSe:DATA:TELEcom:ATM:CDV:UPCR <numeric> is required.

The corresponding query returns the rate type in discrete form as listed above.

:SENSe:DATA:TELEcom:ATM:CDV:PCRate?

Returns : <discrete>

:SENSe:DATA:TELEcom:ATM:CDV:UPCR <numeric>

<numeric> = 100 to MAX Peak Cell Rate

Selects the Peak Cell Rate (PCR). The Maximum PCR is dependent on the selection made under :INPut:TELEcom:ATM:RATE <discrete>

- M2 (2 Mb/s) - 4528 cells/s
- M34 (34Mb/s) - 80,000 cells/s
- M140 (140 Mb/s) - 326,037 cells/s
- SDH or OPT1 or OPT4 (155 Mb/s) - 353,207 cells/s

The corresponding query returns the peak cell rate in discrete form as listed above.

:SENSe:DATA:TELEcom:ATM:CDV:UPCR?

Returns : <numeric>

SENSe subsystem - Receiver ATM Settings

:SENSe:DATA:TELEcom:ATM:CDV:TOLerance <discrete>

<discrete> = USER User defined
 DISabled Non conforming cell count disabled

Selects the Cell Delay Variation, Tolerance type. If USER is selected, further selection of :SENS:DATA:TEL:ATM:CDV:UTOL is required.

The corresponding query returns the tolerance type in discrete form as listed above.

:SENSe:DATA:TELEcom:ATM:CDV:TOLerance?

Returns : <discrete>

:SENSe:DATA:TELEcom:ATM:CDV:UTOL <numeric>

<numeric> = 10 to 1000000 10 μ s steps

Selects the user defined cell delay tolerance value in 10 μ s steps. .

The corresponding query returns the tolerance in numeric form.

:SENSe:DATA:TELEcom:ATM:CDV:UTOL?

Returns : <numeric>

:SENSe:DATA:TELEcom:ATM:POAM <discrete>

<discrete> = OFF
 SEGMent Segment
 ENDToend End to End

Selects the Performance Management OAM analysis type. Only valid when :SENS :DATA:TEL:ATM:PAYL LIVE is selected in conjunction with :SENS :DATA :TEL:ATM:SEL VPV or VCV. Further selection of SENS:DATA:TEL:ATM :POAM:BLOC is required.

The corresponding query returns the OAM analysis type in discrete form as listed above.

ATM Command Reference

SENSe subsystem - Receiver ATM Settings

:SENSe:DATA:TELEcom:ATM:POAM?

Returns : <discrete>

:SENSe:DATA:TELEcom:ATM:POAM:BLOCK <discrete>

<discrete> = BS128
BS256
BS512
BS1024

Sets the length of the OAM analysis block.

The corresponding query returns the OAM analysis block length in discrete form as listed above.

:SENSe:DATA:TELEcom:ATM:POAM:BLOCK?

Returns : <discrete>

SENSe subsystem - Result Returning Commands

SENSe subsystem - Result Returning Commands

ATM (Option UKN) + SDH	ATM (Option UKN) + SPDH	ATM Physical, and Cell Layer (Option UKZ)
RS B1 BIP (SDH only) MS B2 BIP (SDH only) PATH B3 BIP (SDH only) Non Corrected HEC Corrected HEC Lost Cells Misinserted Cells Path FEBE/HP-REI Bit Errored Cells	EM BIP Non Corrected HEC Corrected HEC Lost Cells Misinserted Cells EM FEBE Bit Errored Cells	FRAME CODE CP-Parity (DS3) P-Parity (DS3) CRC6 (DS1) PLCP-BIP8 (DS3) FEBE (DS3) PLCP-FRBE (DS3) PLCP Trailer Then as for ATM Option UKN

ATM Short Term Results

:SENSe:DATA? <"result">

- | | |
|--|-------------------------------|
| Result = "ECOunt:ATM:STERm:EMBip" | EMBIP error count |
| "ERATio:ATM:STERm:EMBip" | EMBIP error ratio |
| "ECOunt:ATM:STERm:FEBE" or
"ECOunt:ATM:STERm:REI" | FEBE/REI error count |
| "ERATio:ATM:STERm:FEBE" | FEBE error ratio |
| "ECOunt:ATM:STERm:CHEC" | Corrected HEC error count |
| "ERATio:ATM:STERm:CHEC" | Corrected HEC error ratio |
| "ECOunt:ATM:STERm:NChec" | Non Corrected HEC error count |
| "ERATio:ATM:STERm:NChec" | Non Corrected HEC error ratio |
| "ECOunt:ATM:STERm:BIT" | Cell Bit error count |
| "ERATio:ATM:STERm:BIT" | CELL Bit error ratio |
| "ECOunt:ATM:STERm:LCELI" | Cell Loss count |
| "ERATio:ATM:STERm:LCELI" | Cell Loss ratio |

ATM Command Reference

SENSe subsystem - Result Returning Commands

"ECOunt:ATM:STERm:NCCell"	Non Conforming Cell count
"ERATio:ATM:STERm:NCCell"	Non Conforming Cell ratio
"ECOunt:ATM:STERm:RCELL"	Received Cell Count
"ERATio:ATM:STERm:RCELL"	Received Cell rate
"ECOunt:ATM:STERm:MCELL"	Misinserted cell count
"ERATio:ATM:STERm:MCELL"	Misinserted cell rate
"ECOunt:ATM:STERm:ECELL"	Errored cell count
"ERATio:ATM:STERm:ECELL"	Errored cell ratio
"ECOunt:ATM:STERm:CRC4"	CRC4 Multiframe error count
"ERATio:ATM:STERm:CRC4"	CRC4 Multiframe error ratio
"ECOunt:ATM:STERm:REBE"	REBE error count
"ERATio:ATM:STERm:REBE"	REBE error ratio
"ECOunt:ATM:STERm:BEDC"	Block Error Detection Code count
"ERATio:ATM:STERm:BEDC"	Block Error Detection Code ratio

ATM Cumulative Results

:SENSe:DATA? <"result">

Result =	"ECOunt:ATM:EMBip"	EM BIP error count
	"ERATio:ATM:EMBip"	EM BIP error ratio
	"ECOunt:ATM:FEBE" or "ECOunt:ATM:REI"	FEBE error count
	"ERATio:ATM:FEBE"	FEBE error ratio
	"ECOunt:ATM:CHEC"	Corrected HEC error count
	"ERATio:ATM:CHEC"	Corrected HEC error ratio
	"ECOunt:ATM:NCHeC"	Non Corrected HEC error count
	"ERATio:ATM:NCHeC"	Non Corrected HEC error ratio
	"ECOunt:ATM:BIT"	Cell Bit error count

SENSe subsystem - Result Returning Commands

"ERATio:ATM:BIT"	CELL Bit error ratio
"ECOunt:ATM:LCELI"	Cell Loss count
"ERATio:ATM:LCELI"	Cell Loss ratio
"ECOunt:ATM:NCCellI"	Non Conforming Cell count
"ERATio:ATM:NCCell"	Non Conforming Cell ratio
"ECOunt:ATM:RCELI"	Received Cell Count
"ERATio:ATM:RCELI"	Received Cell rate
"ECOunt:ATM:MCELI"	Misinserted cell count
"ERATio:ATM:MCELI"	Misinserted cell rate
"ECOunt:ATM:ECELI"	Errored cell count
"ERATio:ATM:ECELI"	Errored cell ratio
"ECOunt:ATM:CRC4"	CRC4 Multiframe error count
"ERATio:ATM:CRC4"	CRC4 Multiframe error ratio
"ECOunt:ATM:REBE"	REBE error count
"ERATio:ATM:REBE"	REBE error ratio
"ECOunt:ATM:BEDC"	Block error Detection Code count
"ERATio:ATM:BEDC"	Block error Detection Code ratio
"ECOunt:ATM:GMCTdelay"	Gated Mean Cell Transfer Delay count
"ECOunt:ATM:MXCTdelay"	Maximum Cell Transfer Delay count
"ECOunt:ATM:PPCDv"	Pk-to-Pk 2 point Cell Delay Variation
"ECOunt:ATM:MXCDv"	Maximum 1 point Cell Delay Variation

ATM Command Reference
SENSe subsystem - Result Returning Commands

ATM EM BIP Analysis Results

:SENSe:DATA? <"result">

Result =	"ESECONDS:ATM:EMBIP:ANALYSIS"	Error seconds
	"EBCOUNT:ATM:EMBIP:ANALYSIS"	Errored block count
	"BBECOUNT:ATM:EMBIP:ANALYSIS"	Background block error count
	"ESRATIO:ATM:EMBIP:ANALYSIS"	Error seconds ratio
	"SESECONDS:ATM:EMBIP:ANALYSIS"	Severely errored seconds
	"SESRATIO:ATM:EMBIP:ANALYSIS"	Severely errored seconds ratio
	"BBERATIO:ATM:EMBIP:ANALYSIS"	Block error ratio
	"UASECONDS:ATM:EMBIP:ANALYSIS"	Unavailable seconds
	"PUASECONDS:ATM:EMBIP:ANALYSIS"	Path Unavailable seconds

ATM FEBE/REI Analysis Results

:SENSe:DATA? <"result">

Result =	"ESECONDS:ATM:FEBE:ANALYSIS" or "ESECONDS:ATM:REI:ANALYSIS"	Error seconds
	"EBCOUNT:ATM:FEBE:ANALYSIS" or "EBCOUNT:ATM:REI:ANALYSIS"	Errored block count
	"BBECOUNT:ATM:FEBE:ANALYSIS" or "BBECOUNT:ATM:REI:ANALYSIS"	Background block error count
	"ESRATIO:ATM:FEBE:ANALYSIS" or "ESRATIO:ATM:REI:ANALYSIS"	Error seconds ratio
	"SESECONDS:ATM:FEBE:ANALYSIS" or "SESECONDS:ATM:REI:ANALYSIS"	Severely errored seconds
	"SESRATIO:ATM:FEBE:ANALYSIS" or "SESRATIO:ATM:REI:ANALYSIS"	Severely errored seconds ratio
	"BBERATIO:ATM:FEBE:ANALYSIS" or "BBERATIO:ATM:REI:ANALYSIS"	Block error ratio

SENSe subsystem - Result Returning Commands

"UASconds:ATM:FEBE:ANALysis" or "UASconds:ATM:REI:ANALysis"	Unavailable seconds
"PUASconds:ATM:FEBE:ANALysis" or "PUASconds:ATM:REI:ANALysis"	Path Unavailable seconds

ATM REBE Analysis Results

:SENSe:DATA? <"result">

Result = "ESECONDS:ATM:REBE:ANALysis"	Error seconds
"EBCOUNT:ATM:REBE:ANALysis"	Errored block count
"BBECOUNT:ATM:REBE:ANALysis"	Background block error count
"ESRATIO:ATM:REBE:ANALysis"	Error seconds ratio
"SECONDS:ATM:REBE:ANALysis"	Severely errored seconds
"SESRATIO:ATM:REBE:ANALysis"	Severely errored seconds ratio
"BBERATIO:ATM:REBE:ANALysis"	Block error ratio
"UASconds:ATM:REBE:ANALysis"	Unavailable seconds
"PUASconds:ATM:REBE:ANALysis"	Path Unavailable seconds

ATM CRC4 Analysis Results

:SENSe:DATA? <"result">

Result = "ESECONDS:ATM:CRC4:ANALysis"	Error seconds
"EBCOUNT:ATM:CRC4:ANALysis"	Errored block count
"BBECOUNT:ATM:CRC4:ANALysis"	Background block error count
"ESRATIO:ATM:CRC4:ANALysis"	Error seconds ratio
"SECONDS:ATM:CRC4:ANALysis"	Severely errored seconds
"SESRATIO:ATM:CRC4:ANALysis"	Severely errored seconds ratio
"BBERATIO:ATM:CRC4:ANALysis"	Block error ratio

SENSe subsystem - Result Returning Commands

"UASconds:ATM:CRC4:ANALysis" Unavailable seconds
 "PUASconds:ATM:CRC4:ANALysis" Path Unavailable seconds

ATM Alarm Seconds Results

:SENSe:DATA? <"result">

Result = "ASEconds:ATM:PSLoss" Pattern sync loss seconds
 "ASEconds:ATM:CSLoss" Cell sync loss seconds
 "ASEconds:ATM:SCNReceived" Selected Cell not received seconds
 "ASEconds:ATM:CEXPerienced" Congestion experienced seconds
 "ASEconds:ATM:VPAis" VP AIS seconds
 "ASEconds:ATM:VPFerf" or
 "ASEconds:ATM:VPRDi" VP FERF/VP-RDI seconds
 "ASEconds:ATM:VPLoc" VP Loss of Continuity seconds
 "ASEconds:ATM:VCAis" VC AIS seconds
 "ASEconds:ATM:VCFerf" or
 "ASEconds:ATM:VCRDi" VC FERF/VC-RDI seconds
 "ASEconds:ATM:VCLoc" VC Loss of Continuity
 "ASEconds:ATM:TCLoss" Test Cell Loss seconds
 "ASEconds:ATM:RAI" RAI seconds
 "ASEconds:ATM:LPM" Loss of Perf. Man. OAM seconds

ATM Mean Cell Transfer Delay Results

:SENSe:DATA? <"result">

Result = "DElay:ATM:MCTDelay" ATM Mean Cell Transfer Delay

FETCh subsystem

FETCh subsystem

The FETCh subsystem is used to retrieve data directly accumulated by the instrument.

:FETCh:STRing:DATA:TELEcom:ATM:TTRace?

Returns : <string>

Option UKN only. Returns the value of the trail trace byte as a 16 character ASCII string.

:FETCh:STRing:DATA:TELEcom:ATM:TTRace:HEXadecimal?

Returns : <block>

Option UKN only. Returns the value of the trail trace byte as 16 hexadecimal numbers. Each number is in the range "00" to "FF". The block header is "#264". This is a snapshot of the byte and is captured once per second.

Jitter SCPI Command Reference

OUTPut subsystem, see page 7- 4.

SOURce subsystem - Transmitter Jitter Commands, see page 7- 6.

SENSe subsystem - Receiver Jitter Settings, see page 7- 21.

SENSe subsystem - Result Returning Commands, see page 7- 24.

FETCh subsystem, see page 7-26.

Jitter Command Reference

Jitter Command Reference

Jitter Command Reference

This chapter contains detailed information on the SCPI (Standard Commands for Programming Instruments) and IEEE 488.2 common commands you will use when writing programs to control your HP 37717C for Jitter operation.

Please also refer to chapter 2 Common Commands for general information on SCPI command formats and for a list of commands that are common to PDH, SDH, SONET, ATM or Jitter operation; they are as follows:

SCPI Command Format

Remote Control Commands

Instrument Options

INSTRument subsystem

SOURce subsystem

SOURce subsystem - Transmitter Common Commands

INPut subsystem

SENSe subsystem

SENSe subsystem - Receiver Common Commands

SENSe subsystem - Test Timing

SENSe subsystem - Analysis Control

SENSe subsystem - Trouble Scan Results

SENSe subsystem - Configuring Graphics

SENSe subsystem - Managing Graphics Stores

SENSe subsystem - Retrieving Graphics Store Data

SENSe subsystem - Retrieving Data for a Single Graph

SENSe subsystem - Obtaining Graphics End of Measurement Results

STATus Subsystem

SYSTem Subsystem

IEEE common capabilities

OUTPut subsystem

OUTPut subsystem

This subsystem controls the characteristics of the instrument's output ports.

:OUTPut:TELEcom:JITTer <discrete>

<discrete> =	OFF	Jitter Disabled
	ON	Jitter Enabled
	AUTotol	Auto Tolerance Mode
	TRANsfer	Jitter Transfer (Requires Jitter Measurement option)

Selects the jitter modulation operating mode. When AUTotol is selected a further selection of :OUTPut:TELEcom:JITTer:AUTotol <boolean> is required. When TRANsfer is selected further selections of :OUTPut:TELEcom:JITTer:TRANsfer <boolean> and :OUTPut:TELEcom:JITTer:TRANsfer:CALibrate? are required.

The corresponding query command returns the jitter modulation mode in discrete short form.

:OUTPut:TELEcom:JITTer?

Returns: <discrete>

:OUTPut:TELEcom:JITTer:AUTotol <boolean>

<boolean> = 0 or OFF
1 or ON

Start or stop the jitter auto tolerance mode. When ON is selected, further selections under :SOURce:DATA:TELEcom:JITTer:ATOLerance:DELay <numeric> and other AUTotol commands are required.

The corresponding query command returns the jitter auto tolerance mode as 0 or 1.

:OUTPut:TELEcom:JITTer:AUTotol?

Returns : 0 or 1

Jitter Command Reference

OUTPut subsystem

:OUTPut:TELEcom:JITTer:TRANsfer <boolean>

<boolean> =	0 or OFF	Jitter Transfer disabled
	1 or ON	Jitter Transfer enabled

Requires a Jitter Measurement option also. Enable/Disable the jitter transfer mode. When ON is selected further selections under :SOURce:DATA:TELEcom:JITTer:TRANsfer:MODE <discrete> and related commands are required.

The corresponding query command returns the jitter transfer mode as 0 or 1.

:OUTPut:TELEcom:JITTer:TRANsfer?

Returns:	0 or 1
----------	--------

:OUTPut:TELEcom:JITTer:TRANsfer:CALibrate?

Returns:	0	Calibration invalid
	1	Calibration valid

Requires a Jitter Measurement option also. Returns the validity of the jitter transfer calibration. To initiate a jitter transfer Calibration or measurement further selections under :SOURce:DATA:TELEcom:JITTer:TRANsfer:MODE <discrete> and related commands are required.

:OUTPut:TELEcom:JITTer:WANDer <boolean>

<boolean> =	0 or OFF
	1 or ON

Option A3Konly. Enables or disables wander generation. Jitter generation is automatically disabled when wander generation is enabled.

The corresponding query command returns the wander generation state as 0 or 1.

:OUTPut:TELEcom:JITTer:WANDer?

Returns :	0 or 1
-----------	--------

SOURce subsystem - Transmitter Jitter Commands

SOURce subsystem - Transmitter Jitter Commands

:SOURce:DATA:TELEcom:JITTer:MASK <discrete>

<discrete> =	OFF	No mask
	SWEPT	Swept mask
	SPOT	Spot frequency on mask

If SWEPT is selected, further selections of

:SOURce:DATA:TELEcom:JITTer:FREQUency <numeric> and

:SOURce:DATA:TELEcom:JITTer:AMPLitude <numeric> are required. If SPOT is

selected, further selection of :SOURce:DATA:TELEcom:JITTer:FREQUency <numeric> is required.

The corresponding query returns the selected jitter mask mode in discrete form, as listed above.

:SOURce:DATA:TELEcom:JITTer:MASK?

Returns : <discrete>

:SOURce:DATA:TELEcom:JITTer:FREQUency <numeric>

<numeric> = 0.1 to 5000000 Frequency in Hz

Sets the jitter modulation/spot frequency in Hz. If Option UHK, 2 to 4000000 Hz

The corresponding query returns the selected jitter frequency in numeric form, as listed above.

:SOURce:DATA:TELEcom:JITTer:FREQUency?

Returns : <numeric>

:SOURce:DATA:TELEcom:JITTer:AMPLitude <numeric>

<numeric> = 0.01 to 200.00 Amplitude in UI

Jitter Command Reference

SOURCE subsystem - Transmitter Jitter Commands

Sets the jitter modulation amplitude in UI. The absolute maximum value is 10 UI for PDH clock rates and 5 UI for SDH (If Option UHN). The absolute maximum value is 80 UI for PDH 2 Mb/s, 50 UI for SDH STM-1 rates and 200 UI for SDH STM-4 rates. (If Option A3K). The maximum value changes according to the modulation frequency. If a value that exceeds the maximum permitted values is requested, the amplitude is set to the maximum permitted value for that frequency. Amplitude should only be set if :SOURCE:DATA:TELEcom:JITTer:MASK <discrete> is set to <OFF.> and :OUTPUT:TELEcom:JITTer:AUTotol <boolean> is set to OFF.

The corresponding query returns the selected jitter amplitude in numeric form, as listed above.

:SOURCE:DATA:TELEcom:JITTer:AMPLitude?

Returns : <numeric>

:SOURCE:DATA:TELEcom:JITTer:RANGe <discrete>

<discrete> =	UI1_0	1.0 UI range
	UI10	10 UI range
	UI50	SDH STM-1, A3K only
	UI80	PDH 2 Mb/s , A3K only
	UI200	SDH STM-4, A3K only

Selects the jitter generation amplitude range.

The corresponding query returns the selected jitter generation amplitude range in discrete form, as listed above.

:SOURCE:DATA:TELEcom:JITTer:RANGe?

Returns : <discrete>

:SOURCE:DATA:TELEcom:JITTer:QFACTOR <discrete>

<discrete> =	QLOW	Low Q-factor
	QHIGh	High Q-factor

Jitter Command Reference

SOURce subsystem - Transmitter Jitter Commands

Selects the PDH jitter Q-factor. Only valid when :OUTPut:TELEcom:PDH:RATE <discrete> is set to M2 or M8, or :OUTPut:TELEcom:SPDH:RATE <discrete> is set to M2 or M8.

The corresponding query returns the selected PDH jitter Q-factor in discrete form, as listed above.

SOURce subsystem - Transmitter Jitter Commands

:SOURce:DATA:TELEcom:JITTer:QFACtor?

Returns : <discrete>

:SOURce:DATA:TELEcom:JITTer:SDHMask <discrete>

<discrete> =	ATYPe	Type A
	BTYPe	Type B

Selects the G.958 mask appropriate for type A or type B regenerators when generating SDH jitter.

The corresponding query returns the selected SDH jitter mask type in discrete form, as listed above.

:SOURce:DATA:TELEcom:JITTer:SDHMask?

Returns : <discrete>

:SOURce:DATA:TELEcom:JITTer:ATOLerance:DELay <numeric>

<numeric> = 0.0 .. 99.9

Set the delay in seconds between each autotolerance modulation frequency and amplitude setting. During this delay the output is not jittered. This delay does not include transmitter settling times. The corresponding query returns the delay in numeric form.

:SOURce:DATA:TELEcom:JITTer:ATOLerance:DELay?

Returns : <numeric>

:SOURce:DATA:TELEcom:JITTer:ATOLerance:DWELl <numeric>

<numeric> = 1.0 .. 99.9

Set the time in seconds spent gating at each autotolerance, modulation frequency and amplitude, setting.

The corresponding query returns the dwell time in numeric form.

SOURce subsystem - Transmitter Jitter Commands

:SOURce:DATA:TELEcom:JITTer:ATOLerance:DWELI?

Returns : <numeric>

:SOURce:DATA:TELEcom:JITTer:ATOLerance:THREshold <numeric>

<numeric> = 0 .. 1000000

Set the number of bit errors that constitute an error for each autotolerance gating period as specified by the dwell time. When this value is 0 any errors are assumed to constitute an error otherwise only bit errors are tested. If an alarm that suppresses bit error measurements is present then it is assumed that this threshold has been exceeded. The corresponding query returns the threshold value in numeric form.

:SOURce:DATA:TELEcom:JITTer:ATOLerance:THREshold?

Returns : <numeric>

:SOURce:DATA:TELEcom:JITTer:ATOLerance:POINts <numeric>

<numeric> = 3.. 55

Set the number of frequency points at which autotolerance is tested.

The corresponding query returns the number of frequency points.

:SOURce:DATA:TELEcom:JITTer:ATOLerance:POINts?

Returns : <numeric>

:SOURce:DATA:TELEcom:JITTer:TRANsfer:MODE <discrete>

<discrete> = CALib Start Jitter Transfer Calibration
MEASure Start Jitter Transfer Measurement

Option A3L, A3V, A3N only. Selects the jitter transfer mode.

The corresponding query returns the selected jitter transfer mode in discrete short form.

SOURCE subsystem - Transmitter Jitter Commands

:SOURCE:DATA:TELEcom:JITTer:TRANsfer:MODE?

Returns: <discrete>

:SOURCE:DATA:TELEcom:JITTer:TRANsfer:POINts <numeric>

<numeric> = 1 to 55

Option A3L, A3V, A3N only. Set the number of frequency points at which jitter transfer is tested.

The corresponding query returns the number of frequency points.

:SOURCE:DATA:TELEcom:JITTer:TRANsfer:POINts?

Returns: <numeric>

:SOURCE:DATA:TELEcom:JITTer:TRANsfer:DELay <numeric>

<numeric> = 5.0 to 99.9

Option A3L, A3V, A3N only. Set the delay in seconds between each jitter transfer modulation frequency and amplitude setting. During this delay the output is not jittered. This delay does not include transmitter settling times.

The corresponding query returns the delay in numeric form.

:SOURCE:DATA:TELEcom:JITTer:TRANsfer:DELay?

Returns: <numeric>

:SOURCE:DATA:TELEcom:JITTer:TRANsfer:DWELl <numeric>

<numeric> = 5 to 30

Option A3L, A3V, A3N only. Set the data acquisition time, at each jitter transfer point, in 1 second steps. The corresponding query returns the dwell time in numeric form.

:SOURCE:DATA:TELEcom:JITTer:TRANsfer:DWELl?

Returns: <numeric>

SOURce subsystem - Transmitter Jitter Commands

:SOURce:DATA:TELEcom:JITTer:TRANsfer:MASK:INPut <discrete>

<discrete> =	QLOW	G.823 Low-Q (2 Mb/s & 8 Mb/s only)
	QHIGh	G.823 High-Q (2 Mb/s & 8 Mb/s only)
	G823	G.823 (34 Mb/s & 140 Mb/s)
	ATYPe	G.958 Type A (SDH rates)
	BTYPe	G.958 Type B (SDH rates)
	USER	User selectable mask (All PDH & SDH rates)

Option A3L, A3V, A3N only. Selects the input mask for jitter transfer.

The corresponding query returns the selected input mask in discrete short form.

:SOURce:DATA:TELEcom:JITTer:TRANsfer:MASK:INPut?

Returns: <discrete>

:SOURce:DATA:TELEcom:JITTer:TRANsfer:MASK:INPut:A1 <numeric>

<numeric> = 0.1 to 10.0 UI

Option A3L, A3V, A3N only. Sets the first amplitude point of the user defined input mask.

The corresponding query returns the amplitude in numeric form.

:SOURce:DATA:TELEcom:JITTer:TRANsfer:MASK:INPut:A1?

Returns: <numeric>

:SOURce:DATA:TELEcom:JITTer:TRANsfer:MASK:INPut:A2 <numeric>

<numeric> = 0.1 to 0.5 UI

Option A3L, A3V, A3N only. Sets the second amplitude point of the user defined input mask.

The corresponding query returns the amplitude in numeric form.

:SOURce:DATA:TELEcom:JITTer:TRANsfer:MASK:INPut:A2?

Returns: <numeric>

SOURce subsystem - Transmitter Jitter Commands

:SOURce:DATA:TELEcom:JITTer:TRANSfer:MASK:INPut:F1 <numeric>

<numeric> = 15 to 5000000 Hz

Option A3L, A3V, A3N only. Sets the first frequency point of the user defined input mask.

The corresponding query returns the frequency in numeric form.

:SOURce:DATA:TELEcom:JITTer:TRANSfer:MASK:INPut:F1?

Returns: <numeric>

:SOURce:DATA:TELEcom:JITTer:TRANSfer:MASK:INPut:F2 <numeric>

<numeric> = 15 to 5000000 Hz

Option A3L, A3V, A3N only. Sets the second frequency point of the user defined input mask.

The corresponding query returns the frequency in numeric form.

:SOURce:DATA:TELEcom:JITTer:TRANSfer:MASK:INPut:F2?

Returns: <numeric>

:SOURce:DATA:TELEcom:JITTer:TRANSfer:MASK:INPut:F3 <numeric>

<numeric> = 15 to 5000000 Hz

Option A3L, A3V, A3N only. Sets the third frequency point of the user defined input mask.

The corresponding query returns the frequency in numeric form.

:SOURce:DATA:TELEcom:JITTer:TRANSfer:MASK:INPut:F3?

Returns: <numeric>

:SOURce:DATA:TELEcom:JITTer:TRANSfer:MASK:INPut:F4 <numeric>

<numeric> = 15 to 5000000 Hz

Option A3L, A3V, A3N only. Sets the fourth frequency point of the user defined input mask.

The corresponding query returns the frequency in numeric form.

SOURce subsystem - Transmitter Jitter Commands

:SOURce:DATA:TELEcom:JITTer:TRANsfer:MASK:INPut:F4?

Returns: <numeric>

:SOURce:DATA:TELEcom:JITTer:TRANsfer:MASK:PASS <discrete>

<discrete> =	G823	G.823 (All PDH rates)
	ATYPe	G.958 Type A (SDH rates)
	BTYPe	G.958 Type B (SDH rates)

Option A3L, A3V, A3N only. Selects the pass mask for jitter transfer.

The corresponding query returns the selected pass mask in discrete short form.

:SOURce:DATA:TELEcom:JITTer:TRANsfer:MASK:PASS?

Returns: <discrete>

:SOURce:DATA:TELEcom:JITTer:MODulation <discrete>

<discrete> =	INTernal
	EXTernal

Option A3K only. Selects the source of the jitter/wander modulation signal. If INTernal is selected, then the modulation frequency and amplitude can be set on the instrument. If EXTernal modulation is selected, frequency and amplitude are determined by the supplied signal. External modulation is not available when generating wander at SDH rates.

The corresponding query returns the selected jitter/wander modulation source in discrete form, as listed above.

:SOURce:DATA:TELEcom:JITTer:MODulation?

Returns : <discrete>

:SOURce:DATA:TELEcom:JITTer:ERANge <discrete>

<discrete> =	UI2	2 UI range
	UI10	10 UI range

Jitter Command Reference

SOURce subsystem - Transmitter Jitter Commands

Option A3K only. Selects the transmitter output range when using externally modulated jitter.

The corresponding query returns the selected output range in discrete form, as listed above.

:SOURce:DATA:TELEcom:JITTer:ERANge?

Returns : <discrete>

:SOURce:DATA:TELEcom:JITTer:WANDer:MASK <discrete>

<discrete> =	OFF	No mask
	SPOT	Spot frequency

Option A3K only. If OFF is selected, further selections of :SOURce:DATA:TELEcom:JITTer:WANDer:FREQUency <numeric> and :SOURce:DATA:TELEcom:JITTer:WANDer:AMPLitude <numeric> are required. If SPOT is selected, further selection of :SOURce:DATA:TELEcom:JITTer:WANDer:FREQUency <numeric> is required and the amplitude value is derived from the ITU-T G>823/G.958 mask.

The corresponding query returns the selected mask state in discrete form, as listed above.

:SOURce:DATA:TELEcom:JITTer:WANDer:MASK?

Returns : <discrete>

:SOURce:DATA:TELEcom:JITTer:WANDer:FREQUency <numeric>

<numeric> =	10 to125000	micro Hertz
-------------	-------------	-------------

Option A3K only. Sets the wander modulation or spot frequency in micro Hz .

The corresponding query returns the wander modulation or spot frequency.

:SOURce:DATA:TELEcom:JITTer:WANDer:FREQUency?

Returns : <numeric>

SOURce subsystem - Transmitter Jitter Commands

:SOURce:DATA:TELEcom:JITTer:WANDer:AMPLitude <numeric>

<numeric> = 0.5 to14400 UI

Option A3K only. Sets the wander modulation amplitude if :SOURce:DATA:TELEcom:JITTer:WANDer:MASK <discrete> is set to OFF. The absolute maximum value is 80 UI for PDH clock rates. The maximum value for SDH clock rates varies with frequency, up to 3600 UI for SDH STM-1, and up to 14400 UI for SDH STM-4.

Any values exceeding the allowed ranges will result in the amplitude being set to the maximum permitted value for that frequency.

The corresponding query returns the wander modulation amplitude.

:SOURce:DATA:TELEcom:JITTer:WANDer:AMPLitude?

Returns : <numeric>

:SOURce:CLOCK:JITTer:FORMat <discrete>

<discrete> =	DATA	2 Mb/s, HDB3
	CLOCK	2 MHz clock

Option A3K only. Sets the external 2 Mb/s timing reference signal format.

The corresponding query returns the 2 Mb/s timing reference format, in discrete form as listed above.

:SOURce:CLOCK:JITTer:FORMat?

Returns : <discrete>

:SOURce:CLOCK:JITTer:BALance <discrete>

<discrete> =	UNBalanced	75 Ω
	BALanced	120 Ω

Option A3K only. Sets the external 2 Mb/s timing reference signal termination.

The corresponding query returns the 2 Mb/s timing reference termination type, in discrete form as listed above.

SOURce subsystem - Transmitter Jitter Commands

:SOURce:CLOCK:JITTer:BALance?

Returns : <discrete>

:SOURce:DATA:TELEcom:JITTer:SETTings <discrete>

<discrete> =	OFF	Jitter settings display disabled
	ON	Jitter settings display enabled

Enables/disables display of the jitter settings page.

The corresponding query returns an indication of whether the jitter settings page is displayed in discrete form as listed above.

:SOURce:DATA:TELEcom:JITTer:SETTings?

Returns : <discrete>

INPut subsystem

INPut subsystem

This subsystem controls the characteristics of the instrument's input ports.

:INPut:TELEcom:JITTer:RATE <discrete>

<discrete> =	STM1	STM-1 electrical
	STMO1	STM-1 optical
	STMO4	STM-4 optical

Selects the data rate for the SDH Jitter Receiver (Options A3L, A3V, A3N only).

The corresponding query returns the data rate in discrete form, as listed above.

:INPut:TELEcom:JITTer:RATE?

Returns : <discrete>

:INPut:TELEcom:JITTer:GAIN <discrete>

<discrete> =	DB20	All rates
	DB26	All rates

Selects the Monitor gain for the SDH Jitter Receiver (Options A3L, A3V, A3N only). Only valid when :INPut:TELEcom:LEVel <discrete> is set to MON.

The corresponding query returns the Monitor gain in discrete form, as listed above.

:INPut:TELEcom:JITTer:GAIN?

Returns : <discrete>

:INPut:TELEcom:JITTer:EQUal <boolean>

<boolean> =	0 or OFF
	1 or ON

Jitter Command Reference

INPut subsystem

Selects the Monitor equalization for the SDH Jitter Receiver (Options A3L, A3V, A3N only). Only valid when :INPut:TELEcom:LEVel <discrete> is set to MON.

The corresponding query returns the Monitor equalization state in numeric form.

:INPut:TELEcom:JITTer:EQual?

Returns : 0 or 1

:INPut:TELEcom:JITTer:WANDer <boolean>

<boolean> =	0 or OFF	Wander disabled
	1 or ON	Wander enabled

Enables/disables wander measurements. Only valid for 2Mb/s PDH signals.

The corresponding query returns the Wander measurement state in numeric form.

:INPut:TELEcom:JITTer:WANDer?

Returns: 0 or 1

:INPut:TELEcom:JITTer:WANDer:BALance <discrete>

<discrete> =	UNBalanced	75 Ω unbalanced
	BALanced	120 Ω balanced

Selects the Wander reference source.

The corresponding query returns the Wander reference source in discrete form, as listed above.

:INPut:TELEcom:JITTer:WANDer:BALance?

Returns : <discrete>

:INPut:TELEcom:JITTer:WANDer:FORMat <discrete>

<discrete> =	HDB3	2 Mb/s HDB3 data
	CLOCK	2 Mb/s clock

Jitter Command Reference

INPut subsystem

Selects the Wander reference source format.

The corresponding query returns the Wander reference source format in discrete form, as listed above.

:INPut:TELEcom:JITTer:WANDer:FORMat?

Returns : <discrete>

Jitter Command Reference
SENSe subsystem - Receiver Jitter Settings

SENSe subsystem - Receiver Jitter Settings

:SENSe:DATA:TELEcom:JITTer:SETTings <discrete>

<discrete> =	OFF	Jitter measurement disabled
	ON	Jitter measurement enabled

Enables/disables jitter measurement.

The corresponding query returns the state of jitter measurement in discrete form as listed above.

:SENSe:DATA:TELEcom:JITTer:SETTings?

Returns : <discrete>

:SENSe:DATA:TELEcom:JITTer:FILTer <discrete>

<discrete> =	OFF	Filters off
	LP	Low-Pass
	HP1	High-Pass 1
	HP2	High-Pass 2
	LPHP1	Low-Pass & High-Pass 1
	LPHP2	Low-Pass & High-Pass 2
	HPK12	12 kHz High Pass (A3L, A3V & A3N only)

Selects the filters used for jitter measurement. HPK12 is not available if :SENSe:DATA:TELEcom:JITTer:FILTer:RMS <discrete> is set to HPK12.

The corresponding query returns the jitter filter selection in discrete form as listed above.

:SENSe:DATA:TELEcom:JITTer:FILTer?

Returns : <discrete>

SENSe subsystem - Receiver Jitter Settings

:SENSe:DATA:TELEcom:JITTer:FILTer:RMS <discrete>

<discrete> =	OFF	
	HPK12	12 kHz High Pass

Requires an SDH Measurement option. Selects the additional 12 kHz high pass filter for RMS jitter measurement only. HPK12 is not available if

:SENSe:DATA:TELEcom:JITTer:FILTer <discrete> is set to HPK12.

The corresponding query returns the RMS filter selection in discrete short form.

:SENSe:DATA:TELEcom:JITTer:FILTer:RMS?

Returns: <discrete>

:SENSe:DATA:TELEcom:JITTer:RANGe <discrete>

<discrete> =	UI1_6	1.6 UI range
	UI16	16 UI range

Selects the jitter measurement range.

The corresponding query returns the jitter measurement range in discrete form as listed above.

:SENSe:DATA:TELEcom:JITTer:RANGe?

Returns : <discrete>

:SENSe:DATA:TELEcom:JITTer:THReshold <numeric>

<numeric> =	0.05 to 1.60	1.6 UI range
	0.5 to 16.0	16 UI range

Selects the jitter hits measurement threshold.

The corresponding query returns the jitter hits measurement threshold in numeric form as listed above.

Jitter Command Reference

SENSe subsystem - Receiver Jitter Settings

:SENSe:DATA:TELEcom:JITTer:THReshold?

Returns : <numeric>

SENSe subsystem - Result Returning Commands

Jitter/Wander Results

:SENSe:DATA? <"result">

Result = "COUNT:JITT:HITS"	Hit count
"SECOnds:JITT:HITS"	Hit seconds
"FSECOnds:JITT:HITS"	Hit free seconds
"PEAK:JITT:POSitive"	+ve peak Jitter
"PEAK:JITT:NEGative"	-ve peak Jitter
"PEAK:JITT:PKPK"	pk-to-pk Jitter
"PEAK:JITT:STERm:POSitive"	+ve peak Jitter Short Term
"PEAK:JITT:STERm:NEGative"	-ve peak Jitter Short Term
"PEAK:JITT:STERm:PKPK"	pk-to-pk Jitter Short Term
"RMS:JITT"	RMS jitter
"RMS:JITT:STERm"	Short TermRMS jitter
"COUNT:JITT:WANDer:TIERror"	Wander time interval error
"COUNT:JITT:WANDer:SECOnd:TIERror"	Wander time interval error microseconds
"PEAK:JITT:WANDer:POSitive"	+ve peak Wander
"PEAK:JITT:WANDer:SECOnd:POSitive"	+ve peak Wander microseconds
"PEAK:JITT:WANDer:NEGative"	-ve peak Wander
"PEAK:JITT:WANDer:SECOnd:NEGative"	-ve peak Wander microseconds
"PEAK:JITT:WANDer:PKPK"	pk-to-pk Wander
"PEAK:JITT:WANDer:SECOnd:PKPK"	pk-to-pk Wander microseconds
"PEAK:JITT:WANDer:PK15"	pk-to-pk15 min Wander
"PEAK:JITT:WANDer:SECOnd:PK15"	pk-to-pk 15 min Wander microseconds

Jitter Command Reference

SENSe subsystem - Result Returning Commands

"PEAK:JITT:WANDer:PK24"	pk-to-pk 24 hour Wander
"PEAK:JITT:WANDer:PK24:SEConds"	pk-to-pk 24 hour Wander microseconds
"SLIPs:JITT:WANDer:FRAMe"	Estimated frame slips
"SLIPs:JITT:WANDer:BIT"	Estimated bit slips
"FOFFppm:JITT:WANDer:IMPLied"	Wander implied frequency offset

FETCh subsystem

FETCh subsystem

The FETCh subsystem is used to retrieve data directly accumulated by the instrument.

:FETCh:ARRAy:DATA:TELEcom:JITTer:ATOLerance?

Returns (each of one or more rows): <numeric>, <numeric*>, <numeric>

Returns an array of pairs of numbers and a flag with each pair. Each pair represents the frequency and amplitude for each point of the autotolerance plot. The flag will have the value 1 if the point passes the autotolerance test and value 0 if the point fails the autotolerance test. The number of pairs + flag returned depends upon the number of points selected using :SOUR:DATA:TEL:JITT:AUT:POIN.

*If no bit errors have been detected when the jitter transmitter amplitude is maximum, a value of the form ">amp" is returned where "amp" corresponds to the maximum amplitude.

Each numeric pair and flag is followed by CRLF. The data is terminated by EOI.

:FETCh:ARRAy:DATA:TELEcom:JITTer:TRANSfer?

Returns (each of one or more rows): <numeric>, <numeric>, <numeric>, <numeric>, <discrete>

Options A3L, A3V, A3N only. Returns an array of 4 numbers and a flag with each set of 4 numbers. Each set of 4 numbers represents the point number, the jitter frequency, the mask value and the jitter transfer result for each point of the jitter transfer plot. The flag will have the value PASS if the point passes the jitter transfer test and value FAIL if the point fails the jitter transfer test. The number of sets of 4 numbers + flag returned depends upon the number of points selected using :SOUR:DATA:TEL:JITT:TRAN:POIN. Each set of 4 numbers and flag is followed by CRLF. The data is terminated by EOI.

Status Reporting

Status Reporting

Status Reporting

The status reporting capability of the HP 37717C is provided by the Status Registers and the Status Byte. The STATus subsystem and some IEEE common capability commands control the status registers and the status byte.

Table 8-1 **Status Registers**

The following status registers are provided in the HP 37717C and conform to IEEE 488.2:

Status Register	Description
Standard Event	This register is accessed by issuing the *ESR? common capability command.
QUESTionable	Defined by SCPI.
OPERation	Defined by SCPI.
INSTrument	Monitors general instrument conditions and summarizes the DISK status register.
DATA	Summarizes the PDH, FAS, SPDH, SDH, SDH2, JITT, ATM and BIN status registers.
PDH	Monitors the condition of the Unstructured PDH signal. (UPDH option).
FAS	Monitors the condition of the Unstructured PDH FAS signal. (UPDH option).
BINary	Monitors the condition of the PDH Binary signal. (PDH Binary option).
SPDH	Summarizes the M140 , M34, M8, and M2 status registers. (SPDH option).
M140	Monitors the condition of the Structured PDH 140 Mb/s signal. (SPDH option).

Status Reporting

Status Register	Description
M34	Monitors the condition of the Structured PDH 34 Mb/s signal. (SPDH option).
M8	Monitors the condition of the Structured PDH 8 Mb/s signal. (SPDH option).
M2	Monitors the condition of the Structured PDH 2 Mb/s signal. (SPDH option).
DS1	Monitors the condition of the Structured PDH DS1 signal. (SPDH option).
DS2	Monitors the condition of the Structured PDH DS2 signal. (SPDH option).
DS3	Monitors the condition of the Structured PDH DS3 signal. (SPDH option).
SDH/SONet	Monitors the primary conditions of the SDH/SONET signal. (SDH/SONET option).
SDH2/SONet2	Monitors miscellaneous SDH/SONET conditions. (SDH/SONET option).
JITTer	Monitors the condition of the Jitter/Wander signal. (Jitter/Wander option).
ATM	Monitors the condition of the ATM signal. (ATM option).
DISK	Monitors the disk activity.

Status Reporting

General Status Register

The status registers conform to IEEE 488.2 and each comprises 4 registers as shown in Figure 8-1.

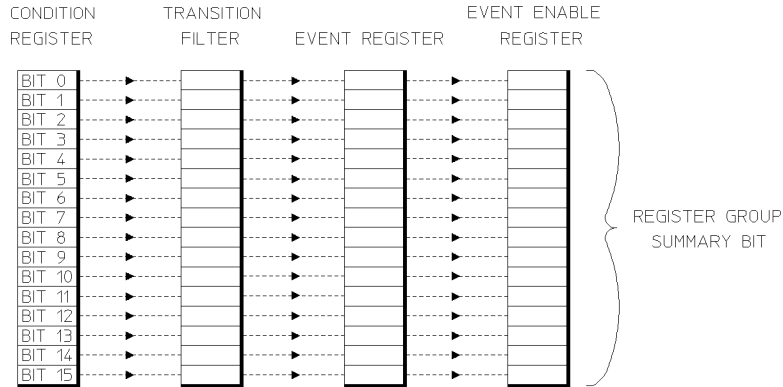

Figure 8-1

General Status Register

Condition Register

Monitors the defined status conditions. There is no latching of conditions in this register, it is updated in real time.

Transition Filter

Determines whether positive or negative transitions (true or false) in the Condition register sets the Event register.

Event Register

Latches the transient states that occur in the Condition register as specified by the Transition Filter.

Event Enable Register

Acts like a mask on the Event register. It determines which bits in the Event register set the summary bit in the Status Byte.

Status Reporting

Status Byte

*STB? or a serial poll - Returns the value of the Status Byte in numeric form.

*SRE <numeric> - Sets the Status Byte mask.

*SRE? - Returns the current mask setting in numeric form.

DB7	DB6	DB5	DB4	DB3	DB2	DB1	DB0
OPER	RQS	ESR	MAV	QUES	-	-	-

DB0 - DB2 Not used, always read as 0.

DB3 QUES - QUEStionable status register summary. Indicates that a bit has been set in the QUEStionable status register.

DB4 MAV - Message Available. Remains set until all output messages are read from the HP 37717C.

DB5 ESR - Event status register summary. Indicates that a bit has been set in the Event status register.

DB6 RQS - Request Service. Set when an SRQ is generated for whatever reason. Cleared by SPOLL or *STB?.

DB7 OPER - OPERation status register summary. Indicates that a bit has been set in the OPERation status register.

Status Reporting

Standard Event Status Register

*ESR? - Returns the Standard Event Status Register value in numeric form.

*ESE <numeric> - Sets the event enable register mask.

*ESE? - Returns the current mask setting.

DB7	DB6	DB5	DB4	DB3	DB2	DB1	DB0
PWR	URQ	CME	EXE	DDE	QUE	RQC	OPC

DB0 OPC - Operation Complete.

DB1 RQC - Request Control.

DB2 QUE - Query Error.

DB3 DDE - Device Dependent Error.

DB4 EXE - Execution Error.

DB5 CME - Command Error.

DB6 URQ - User Request.

DB7 PWR - Power On.

Status Reporting

QUEStionable Status Register

Provides a summary of the DATA status register.

:STATus:QUEStionable:EVENT? - Returns the QUEStionable Status Register value in numeric form.

:STATus:QUEStionable:ENABle <numeric> - Sets the event enable register mask.

:STATus:QUEStionable:ENABle? - Returns the current mask setting in numeric form.

DB15	DB14	DB13	DB12	DB11	DB10	DB9	DB8
-	CMW	-	-	-	-	DATA	-

DB7	DB6	DB5	DB4	DB3	DB2	DB1	DB0
-	-	-	-	-	-	-	-

DB0 - DB8 Not used, always read as 0.

DB9 DATA - DATA status register summary.

DB10 - DB13 Not used, always read as 0.

DB14 CMW - Command Warning

DB15 Not used, always reads as 0.

Status Reporting

OPERation Status Register

Provides a summary of the INSTRument status register, and reports when a measurement is being made.

:STATus:OPERation:EVENT? - Returns the OPERation Status Register value in numeric form.

:STATus:OPERation:ENABLE <numeric> - Sets the event enable register mask.

:STATus:OPERation:ENABLE? - Returns the current mask setting in numeric form.

DB15	DB14	DB13	DB12	DB11	DB10	DB9	DB8
-	-	INST	-	-	-	-	-

DB7	DB6	DB5	DB4	DB3	DB2	DB1	DB0
-	-	-	MEAS	-	-	-	-

DB0 - DB3 Not used, always reads as 0.

DB4 MEAS - Measuring. Currently making a measurement.

DB5 - DB12 Not used, always read as 0.

DB13 INST - INSTRument status register summary.

DB14 - DB15 Not used, always read as 0.

Status Reporting

INSTRUMENT Status Register

Reports the instrument status.

:STATUS:INSTRUMENT:EVENT? - Returns the INSTRUMENT Status Register value in numeric form.

:STATUS:INSTRUMENT:ENABLE <numeric> - Sets the event enable register mask.

:STATUS:INSTRUMENT:ENABLE? - Returns the current mask setting in numeric form.

DB15	DB14	DB13	DB12	DB11	DB10	DB9	DB8
-	-	-	-	-	-	-	-

DB7	DB6	DB5	DB4	DB3	DB2	DB1	DB0
DISK	STP	STC	ASC	-	EOT	LQE	SMG

- DB0** SMG - Graphics Results enabled.
- DB1** LQE - Logging Queue Empty.
- DB2** EOT - End Of Test period.
- DB3** Not used, always read as 0.
- DB4** ASC - Autosetup complete.
- DB5** STC - Self Test complete.
- DB6** STP - Short Term Period complete.
- DB7** DISK - Disk status register summary.
- DB8 - DB15** Not used, always read as 0.

Status Reporting

DATA Status Register

Summarizes the alarm status registers shown. In addition provides a Power Failed alarm indication.

:STATus:DATA:EVENT? - Returns the DATA Status Register value in numeric form.

:STATus:DATA:ENABLE <numeric> - Sets the event enable register mask.

:STATus:DATA:ENABLE? - Returns the current mask setting in numeric form.

DB15	DB14	DB13	DB12	DB11	DB10	DB9	DB8
-	PWF	-	-	-	-	-	BIN

DB7	DB6	DB5	DB4	DB3	DB2	DB1	DB0
-	ATM	SPD H	JITT	SDH2/ SONET2	SDH/ SONET	FAS	PDH

- DB0** PDH - Unstructured PDH status register summary.
- DB1** FAS - FAS status register summary.
- DB2** SDH/SONet - SDH/SONet status register summary.
- DB3** SDH2/SONet2 - SDH2/SONet2 status register summary.
- DB4** JITT - JITTer status register summary.
- DB5** SPDH - SPDH status register summary.
- DB6** ATM - ATM status register summary.
- DB7** Reserved for future use, always read as 0.
- DB8** BIN - BINary status register summary.
- DB9** Reserved for future use, always read as 0.
- DB10-DB13** Not used, always read as 0.
- DB14** PWF - Power Failed during measurement.
- DB15** Not used, always read as 0.

Status Reporting

PDH Status Register

Provides alarm indications related to the Unstructured PDH signal.

:STATus:PDH:EVENT? - Returns the PDH Status Register value in numeric form.

:STATus:PDH:ENABLE <numeric> - Sets the event enable register mask.

:STATus:PDH:ENABLE? - Returns the current mask setting in numeric form.

DB15	DB14	DB13	DB12	DB11	DB10	DB9	DB8
-	ERR	-	-	-	-	FMU	LOC

DB7	DB6	DB5	DB4	DB3	DB2	DB1	DB0
-	-	-	-	-	AIS	PSL	LOS

DB0 LOS - Loss Of Signal.

DB1 PSL - Pattern Synchronization Loss.

DB2 AIS - Alarm Indication Sequence.

DB3 - DB7 Not used, always read as 0.

DB8 LOC - VCXO Lock Loss.

DB9 FMU - Frequency Measurement Update.

DB10 - DB13 Not used, always read as 0.

DB14 ERR - Errors present.

DB15 Not used, always read as 0.

Status Reporting

FAS Status Register

Provides alarm indications related to the Unstructured PDH FAS signal.

:STATus:FAS:EVENT? - Returns the FAS Status Register value in numeric form.

:STATus:FAS:ENABLE <numeric> - Sets the event enable register mask.

:STATus:FAS:ENABLE? - Returns the current mask setting in numeric form.

DB15	DB14	DB13	DB12	DB11	DB10	DB9	DB8
-	-	-	-	-	-	RMFR	RAI

DB7	DB6	DB5	DB4	DB3	DB2	DB1	DB0
-	-	-	-	CAS	CRC	MFM	LOF

DB0 LOF - Loss Of Frame.

DB1 MFM - Multiframe Loss.

DB2 CRC - CRC4 Multiframe Loss.

DB3 CAS - CAS Multiframe Loss.

DB4 - DB7 Not used, always read as 0.

DB8 RAI - Remote Alarm.

DB9 RMFR - Remote Multiframe Alarm.

DB10 - DB15 Not used, always read as 0.

Status Reporting

BINary Status Register

Provides alarm indications related to the PDH Binary signal.

:STATus:BINary:EVENT? - Returns the BINary Status Register value in numeric form.

:STATus:BINary:ENABle <numeric> - Sets the event enable register mask.

:STATus:BINary:ENABle? - Returns the current mask setting in numeric form.

DB15	DB14	DB13	DB12	DB11	DB10	DB9	DB8
-	-	-	-	-	-	FMU	-

DB7	DB6	DB5	DB4	DB3	DB2	DB1	DB0
-	-	-	-	-	-	-	XCL

DB0 XCL -External Binary Clock Loss.

DB9 FMU - External binary clock Frequency Measurement in progress. Cleared when the frequency measurement result has updated.

DB1 - DB15 Not used, always read as 0.

Status Reporting

SDH Status Register

Provides primary alarm indications related to the SDH signal.

:STATus:SDH:EVENT? - Returns the SDH Status Register value in numeric form.

:STATus:SDH:ENABLE <numeric> - Sets the event enable register mask.

:STATus:SDH:ENABLE? - Returns the current mask setting in numeric form.

DB15	DB14	DB13	DB12	DB11	DB10	DB9	DB8
-	ERR	LPRDI	TUAIS	TULOP	HPRDI	MSRDI	H4

DB7	DB6	DB5	DB4	DB3	DB2	DB1	DB0
CSL	PSL	AUAIS	MSAIS	LOP	OOF	LOF	LOS

DB0	LOS - Loss Of Signal.
DB1	LOF - Loss Of Frame.
DB2	OOF - Out Of Frame.
DB3	LOP - Loss Of Pointer.
DB4	MSAIS - Multiplexer Section AIS.
DB5	AUAIS - AU AIS. (Formerly Path AIS).
DB6	PSL - Pattern Synchronization Loss.
DB7	CSL - Clock Synchronization Loss.
DB8	H4 - H4 LOM.
DB9	MSRDI - Multiplexer Section RDI. (Formerly MS FERF).
DB10	HPRDI - High Order Path RDI. (Formerly Path FERF).
DB11	TULOP - Tributary Loss Of Pointer.
DB12	TUAIS - Tributary Path AIS.
DB13	LPRDI - Low Order Path FERF. (Formerly TU FERF).
DB14	ERR - Errors Alarm.
DB15	Not used, always read as 0.

Status Reporting

SDH2 Status Register

Provides miscellaneous SDH monitoring.

:STATUS:SDH2:EVENT? - Returns the SDH2 Status Register value in numeric form.

:STATUS:SDH2:ENABLE <numeric> - Sets the event enable register mask.

:STATUS:SDH2:ENABLE? - Returns the current mask setting in numeric form.

DB15	DB14	DB13	DB12	DB11	DB10	DB9	DB8
-	BDL	BCL	PSA	RAS	TAS	PSI	FMU

DB7	DB6	DB5	DB4	DB3	DB2	DB1	DB0
ALSC	K1K2	TMNDF	TNDF	TPADJ	MNDF	NDF	PADJ

DB0	PADJ - AU Pointer Adjust.
DB1	NDF - AU Pointer New Data Flag.
DB2	MNDF - AU Pointer Missing New Data Flag.
DB3	TPADJ - TU Pointer Adjust.
DB4	TNDF - TU Pointer New Data Flag.
DB5	TMNDF - TU Pointer Missing New Data Flag.
DB6	K1K2 - K1K2 change.
DB7	ALSC - SDH Alarm/Trib scan in progress.
DB8	FMU - Frequency Measurement Update.
DB9	PSI - TX pointer sequence initialization.
DB10	TAS - TX Async 2 Mb/s Settling.
DB11	RAS - RX Async 2 Mb/s Settling.
DB12	PSA - TX pointer sequence active.
DB13	BCL - SDH Binary Clock Loss.
DB14	BDL - SDH Binary Data Loss.
DB15	Not used, always read as 0.

Status Reporting

SONet Status Register

Provides primary alarm indications related to the SONET signal.

:STATUS:SONet:EVENT? - Returns the SONET Status Register value in numeric form.

:STATUS:SONet:ENABLE <numeric> - Sets the event enable register mask.

:STATUS:SONet:ENABLE? - Returns the current mask setting in numeric form.

DB15	DB14	DB13	DB12	DB11	DB10	DB9	DB8
-	ERR	RDIV	AISV	LOPV	RDIP	RDIL	H4

DB7	DB6	DB5	DB4	DB3	DB2	DB1	DB0
CSL	PSL	AISP	AISL	LOPP	SEF	LOF	LOS

DB0	LOS - Loss Of Signal.
DB1	LOF - Loss Of Frame.
DB2	SEF - Severely Errored Frame Defect.
DB3	LOPP - Loss Of Pointer (LOP-P).
DB4	AISL - Line AIS (AIS-L).
DB5	AISP - Path AIS (AIS-P).
DB6	PSL - Pattern Synchronization Loss.
DB7	CSL - Clock Synchronization Loss.
DB8	H4 - H4 LOM.
DB9	RDIL - Line FERF (RDI-L).
DB10	RDIP - Path FERF (RDI-P).
DB11	LOPV - VT Loss Of Pointer (LOP-V).
DB12	AISV - VT Path AIS (AIS-V).
DB13	RDIV - VT Path FERF. (RDI-V).
DB14	ERR - Errors Alarm.
DB15	Not used, always read as 0.

Status Reporting

SONet2 Status Register

Provides miscellaneous SONet monitoring.

:STATus:SONet2:EVENT? - Returns the SONet2 Status Register value in numeric form.

:STATus:SONet2:ENABLE <numeric> - Sets the event enable register mask.

:STATus:SONet2:ENABLE? - Returns the current mask setting in numeric form.

DB15	DB14	DB13	DB12	DB11	DB10	DB9	DB8
-	BDL	BCL	PSA	RAS	TAS	PSI	FMU

DB7	DB6	DB5	DB4	DB3	DB2	DB1	DB0
ALSC	K1K2	TMNDF	TNDF	TPADJ	MNDF	NDF	PADJ

DB0	PADJ - SPE Pointer Adjust.
DB1	NDF - SPE Pointer New Data Flag.
DB2	MNDF - SPE Pointer Missing New Data Flag.
DB3	TPADJ - VT Pointer Adjust.
DB4	TNDF - VT Pointer New Data Flag.
DB5	TMNDF - VT Pointer Missing New Data Flag.
DB6	K1K2 - K1K2 change.
DB7	ALSC - SONET Alarm/Trib scan in progress.
DB8	FMU - Frequency Measurement Update.
DB9	PSI - TX pointer sequence initialization.
DB10	TAS - TX Async 2 Mb/s Settling.
DB11	RAS - RX Async 2 Mb/s Settling.
DB12	PSA - TX pointer sequence active.
DB13	BCL - SONET Binary Clock Loss.
DB14	BDL - SONET Binary Data Loss.
DB15	Not used, always read as 0.

Status Reporting

JITTer Status Register

Provides alarm indications related to the Jitter measurement.

:STATUS:JITTer:EVENT? - Returns the JITTer Status Register value in numeric form.

:STATUS:JITTer:ENABLE <numeric> - Sets the event enable register mask.

:STATUS:JITTer:ENABLE? - Returns the current mask settings in numeric form.

DB15	DB14	DB13	DB12	DB11	DB10	DB9	DB8
-	JTF	-	JLOL	JLOS	JAT	JSWP	TSET

DB7	DB6	DB5	DB4	DB3	DB2	DB1	DB0
ORCL	XCL	JOVR	EXW	WRSL	WSL	JHT	JSL

DB0	JSL - Jitter Unlock.
DB1	JHT - Jitter Hits.
DB2	WSL - Wander Unlock. (Wander option only)
DB3	WRSL - Wander Reference Unlock. (Wander option only)
DB4	EXW - Excess wander (>5 UI). (Wander option only).
DB5	JOVR - Jitter out of range.
DB6	XCL - Loss of External Timing Reference.
DB7	ORCL - External Timing Reference Out of Range.
DB8	TSET - Jitter transmitter settling.
DB9	JSWP - Jitter sweep in progress.
DB10	JAT - Jitter Autotolerance in progress.
DB11	JLOS - SDH Loss of Signal. (Jitter optical Rx only)
DB12	JLOL - SDH Optical Loss of Light. (Jitter optical Rx only)
DB13- DB15	Not Used, always 0.
DB14	JTF - Jitter Transfer in progress.
DB15	Not Used, always 0.

Status Reporting

SPDH Status Register

Provides alarm indications related to the Structured PDH signal.

:STATUS:SPDH:EVENT? - Returns the SPDH Status Register value in numeric form.

:STATUS:SPDH:ENABLE <numeric> - Sets the event enable register mask.

:STATUS:SPDH:ENABLE? - Returns the current mask setting in numeric form.

DB15	DB14	DB13	DB12	DB11	DB10	DB9	DB8
-	ERR	PSL	ILOS	IPES	DPES	FMU	LOC

DB7	DB6	DB5	DB4	DB3	DB2	DB1	DB0
DS2	ALSC	DS1	DS3	M2	M8	M34	M140

DB0	M140 - M140 status register summary.
DB1	M34 - M34 status register summary.
DB2	M8 - M8 status register summary.
DB3	M2 - M2 status register summary.
DB4	DS3 - DS3 status register summary.
DB5	DS1 - DS1 status register summary.
DB6	ALSC - PDH Alarm Scan in progress.
DB7	DS2 - DS2 status register summary.
DB8	LOC - VCXO Lock Loss. Cleared when the VCXO has locked
DB9	FMU - Frequency Measurement in progress. Cleared when the frequency measurement result has updated.
DB10	DPES - 2 Mb/s Drop Port Elastic Store settled.
DB11	IPES - 2 Mb/s Insert Port Elastic Store settled.
DB12	ILOS - 2 Mb/s Insert Port Loss of Signal.
DB13	PSL - Pattern Synchronization loss.
DB14	ERR - Errors present.
DB15	Not used, always read as 0.

Status Reporting

M140 Status Register

Provides alarm indications related to the Structured PDH 140 Mb/s signal.

:STATus:M140:EVENT? - Returns the M140 Status Register value in numeric form.

:STATus:M140:ENABle <numeric> - Sets the event enable register mask.

:STATus:M140:ENABle? - Returns the current mask setting in numeric form.

DB15	DB14	DB13	DB12	DB11	DB10	DB9	DB8
-	-	DEFO	IEFO	MIN	RAI	-	-

DB7	DB6	DB5	DB4	DB3	DB2	DB1	DB0
-	-	AIS	-	-	-	LOF	LOS

DB0 LOS - Loss Of Signal.

DB1 LOF - Loss Of Frame.

DB2 -DB4 Not used, always read as 0.

DB5 AIS - Alarm Indication Sequence.

DB6 - DB9 Not used, always read as 0.

DB10 RAI - Remote Alarm.

DB11 MIN - Minor Alarm.

DB12 IEFO - Insert port Excess Frequency Offset.

DB13 DEFO - Drop port Excess Frequency Offset.

DB14 - DB15 Not used, always read as 0.

Status Reporting

M34 Status Register

Provides alarm indications related to the Structured PDH 34 Mb/s signal.

:STATus:M34:EVENT? - Returns the M34 Status Register value in numeric form.

:STATus:M34:ENABle <numeric> - Sets the event enable register mask.

:STATus:M34:ENABle? - Returns the current mask setting in numeric form.

DB15	DB14	DB13	DB12	DB11	DB10	DB9	DB8
-	-	DEFO	IEFO	MIN	RAI	-	-

DB7	DB6	DB5	DB4	DB3	DB2	DB1	DB0
-	-	AIS	-	-	-	LOF	LOS

DB0 LOS - Loss Of Signal.

DB1 LOF - Loss Of Frame.

DB2 -DB4 Not used, always read as 0.

DB5 AIS - Alarm Indication Sequence.

DB6 - DB9 Not used, always read as 0.

DB10 RAI - Remote Alarm.

DB11 MIN - Minor Alarm.

DB12 IEFO - Insert port Excess Frequency Offset.

DB13 DEFO - Drop port Excess Frequency Offset.

DB14 - DB15 Not used, always read as 0.

Status Reporting

M8 Status Register

Provides alarm indications related to the Structured PDH 8 Mb/s signal.

:STATUS:M8:EVENT? - Returns the M8 Status Register value in numeric form.

:STATUS:M8:ENABLE <numeric>- Sets the event enable register mask.

:STATUS:M8:ENABLE?- Returns the current mask setting in numeric form.

DB15	DB14	DB13	DB12	DB11	DB10	DB9	DB8
-	-	-	-	MIN	RAI	-	-

DB7	DB6	DB5	DB4	DB3	DB2	DB1	DB0
-	-	AIS	-	-	-	LOF	LOS

DB0 LOS - Loss Of Signal.

DB1 LOF - Loss Of Frame.

DB2 -DB4 Not used, always read as 0.

DB5 AIS - Alarm Indication Sequence.

DB6 - DB9 Not used, always read as 0.

DB10 RAI - Remote Alarm.

DB11 MIN - Minor Alarm.

DB12 - DB15 Not used, always read as 0.

Status Reporting

M2 Status Register

Provides alarm indications related to the Structured PDH 2 Mb/s signal.

:STATUS:M2:EVENT? - Returns the M2 Status Register value in numeric form.

:STATUS:M2:ENABLE <numeric> - Sets the event enable register mask.

:STATUS:M2:ENABLE? - Returns the current mask setting in numeric form.

DB15	DB14	DB13	DB12	DB11	DB10	DB9	DB8
-	-	-	-	MIN	RAI	-	-

DB7	DB6	DB5	DB4	DB3	DB2	DB1	DB0
-	-	AIS	CRC	CAS	RMFR	LOF	LOS

DB0 LOS - Loss Of Signal.

DB1 LOF - Loss Of Frame.

DB2 RMFR - Remote Multiframe Alarm.

DB3 CAS - CAS Multiframe Loss.

DB4 CRC - CRC4 Multiframe Loss.

DB5 AIS - Alarm Indication Sequence.

DB6 - DB9 Not used, always read as 0.

DB10 RAI - Remote Alarm.

DB11 MIN - Minor Alarm.

DB12 - DB15 Not used, always read as 0.

Status Reporting

DS3 Status Register

Provides alarm indications related to the Structured PDH DS3 signal.

:STATUS:DS3:EVENT? - Returns the DS3 Status Register value in numeric form.

:STATUS:DS3:ENABLE <numeric> - Sets the event enable register mask.

:STATUS:DS3:ENABLE? - Returns the current mask setting in numeric form.

DB15	DB14	DB13	DB12	DB11	DB10	DB9	DB8
-	FMM	IDLE	EXZ	-	RAI	DEFO	IEFO

DB7	DB6	DB5	DB4	DB3	DB2	DB1	DB0
-	-	AIS	MFM	-	OOF	-	LOS

DB0	LOS - Loss Of Signal.
DB1	Not used, always read as 0.
DB2	OOF - Out Of Frame.
DB3	Not used, always read as 0.
DB4	MFM - Multiframe Loss.
DB5	AIS - Alarm Indication Sequence.
DB6 - DB7	Not used, always read as 0.
DB8	IEFO - Insert port Excess Frequency Offset.
DB9	DEFO - Drop port Excess Frequency Offset.
DB10	RAI - Remote Alarm. (FERF)
DB11	Not used, always read as 0
DB12	EXZ - Excess Zeros
DB13	IDLE - Idle
DB14	FMM - Frame Mismatch
DB15	Not Used, always read as 0.

Status Reporting

DS2 Status Register

Provides alarm indications related to the Structured PDH DS2 signal.

:STATUS:DS2:EVENT? - Returns the DS2 Status Register value in numeric form.

:STATUS:DS2:ENABLE <numeric> - Sets the event enable register mask.

:STATUS:DS2:ENABLE? - Returns the current mask setting in numeric form.

DB15	DB14	DB13	DB12	DB11	DB10	DB9	DB8
-	-	-	-	-	-	-	-

DB7	DB6	DB5	DB4	DB3	DB2	DB1	DB0
-	-	-	-	-	OOF	-	-

DB2

OOF - Out Of Frame.

Status Reporting

DS1 Status Register

Provides alarm indications related to the Structured PDH DS1 signal.

:STATUS:DS1:EVENT? - Returns the DS1 Status Register value in numeric form.

:STATUS:DS1:ENABLE <numeric> - Sets the event enable register mask.

:STATUS:DS1:ENABLE? - Returns the current mask setting in numeric form.

DB15	DB14	DB13	DB12	DB11	DB10	DB9	DB8
-	-	IDLE	EXZ	-	RAI	-	-

DB7	DB6	DB5	DB4	DB3	DB2	DB1	DB0
-	-	AIS	-	-	OOF	-	LOS

DB0	LOS - Loss Of Signal.
DB1	Not used, always read as 0.
DB2	OOF - Out Of Frame
DB3 - DB4	Not used, always read as 0.
DB5	AIS - Alarm Indication Sequence.
DB6 - DB9	Not used, always read as 0.
DB10	RAI - Remote Alarm. (FERF).
DB11	Not used, always read as 0.
DB12	EXZ - Excess Zeros.
DB13	IDLE - Idle.
DB15	Not used, always read as 0.

Status Reporting

ATM Status Register

Provides alarm indications related to the ATM signal.

:STATUS:ATM:EVENT? - Returns the ATM Status Register value in numeric form.

:STATUS:ATM:ENABLE <numeric> - Sets the event enable register mask.

:STATUS:ATM:ENABLE? - Returns the current mask setting in numeric form.

DB15	DB14	DB13	DB12	DB11	DB10	DB9	DB8
-	ERR	-	PSL	TCL	VCF	VCAIS	VPF

DB7	DB6	DB5	DB4	DB3	DB2	DB1	DB0
VPAIS	CONG	SCNR	LOCS	MCSN	POAM	VCLOC	VPLOC

DB0	VPLOC - Virtual Path Loss of Continuity.
DB1	VCLOC - Virtual Channel Loss of Continuity.
DB2	POAM - Loss of Performance Management OAM.
DB3	MCSN - Monitoring Cell Sequence Number error.
DB4	LOCS - Loss Of Cell Synchronization.
DB5	SNCR - Selected Cell Not Received.
DB6	CONG - Congestion Experienced.
DB7	VPAIS - Virtual Path AIS Alarm.
DB8	VPF - Virtual Path FERF.
DB9	VCAIS - Virtual Channel AIS.
DB10	VCF - Virtual Channel FERF Alarm.
DB11	TCL - Test Cell Loss.
DB12	PSL - Pattern Synchronization Loss.
DB13	Not used, always read as 0.
DB14	ERR - Errors Alarm.
DB15	Not used, always read as 0.

Status Reporting

DISK Status Register

Provides alarm indications related to the Disk.

:STATUS:DISK:EVENT? - Returns the DISK Status Register value in numeric form.

:STATUS:DISK:ENABLE <numeric> - Sets the event enable register mask.

:STATUS:DISK:ENABLE? - Returns the current mask setting in numeric form.

DB15	DB14	DB13	DB12	DB11	DB10	DB9	DB8
-	-	-	-	-	-	-	-

DB7	DB6	DB5	DB4	DB3	DB2	DB1	DB0
-	-	-	-	-	-	-	FMT

DB0 Formatting Disk.

DB1 - DB15 Not used, always read as 0.

Status Reporting

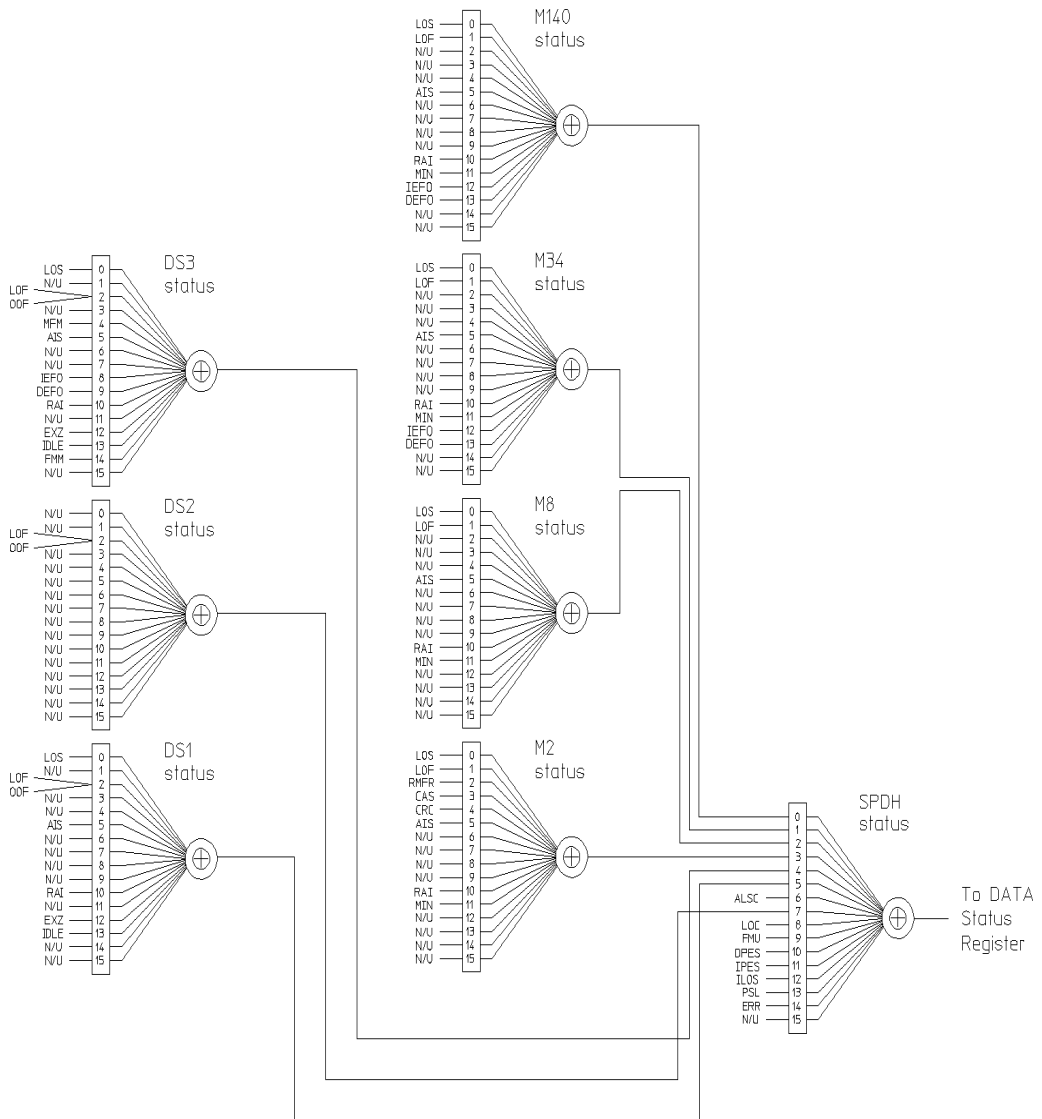

Figure 8-2 Status Registers Relationship 1

Status Reporting

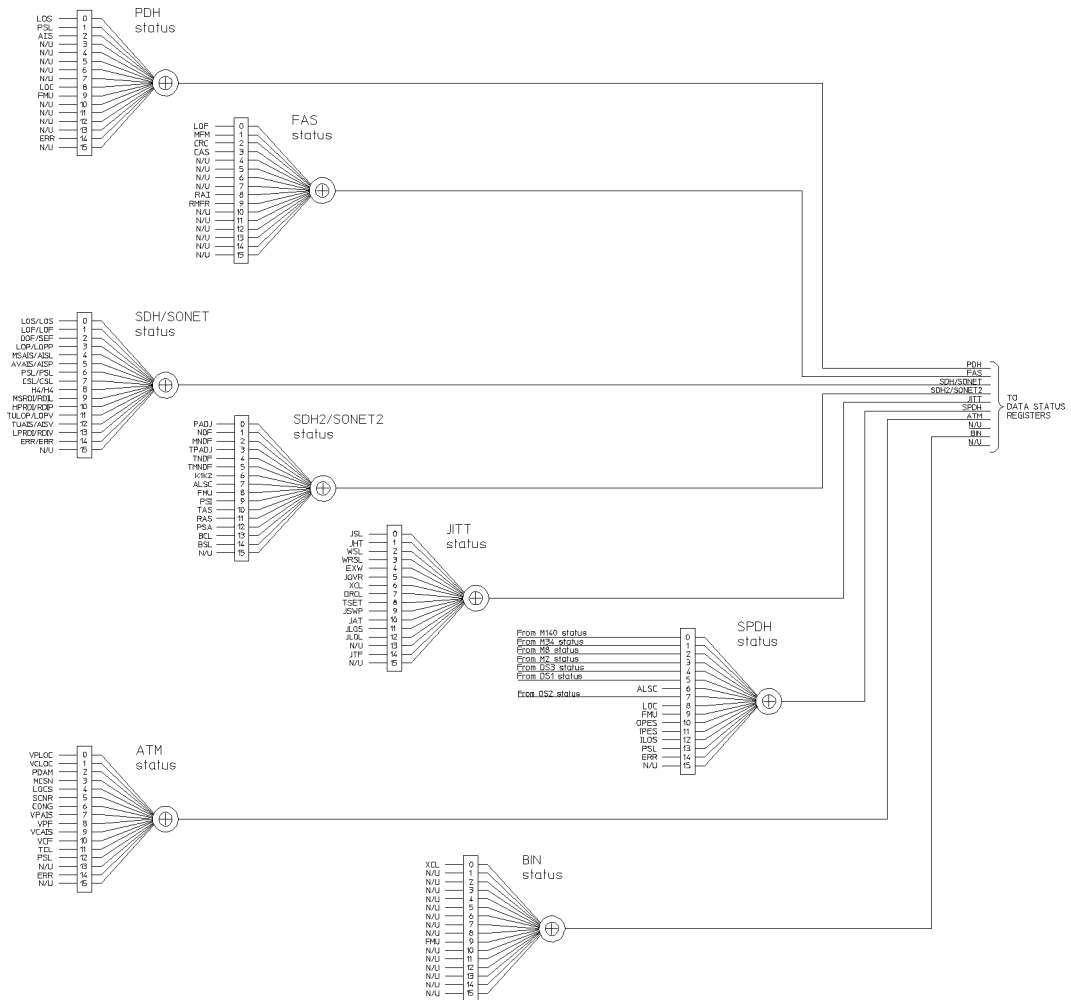
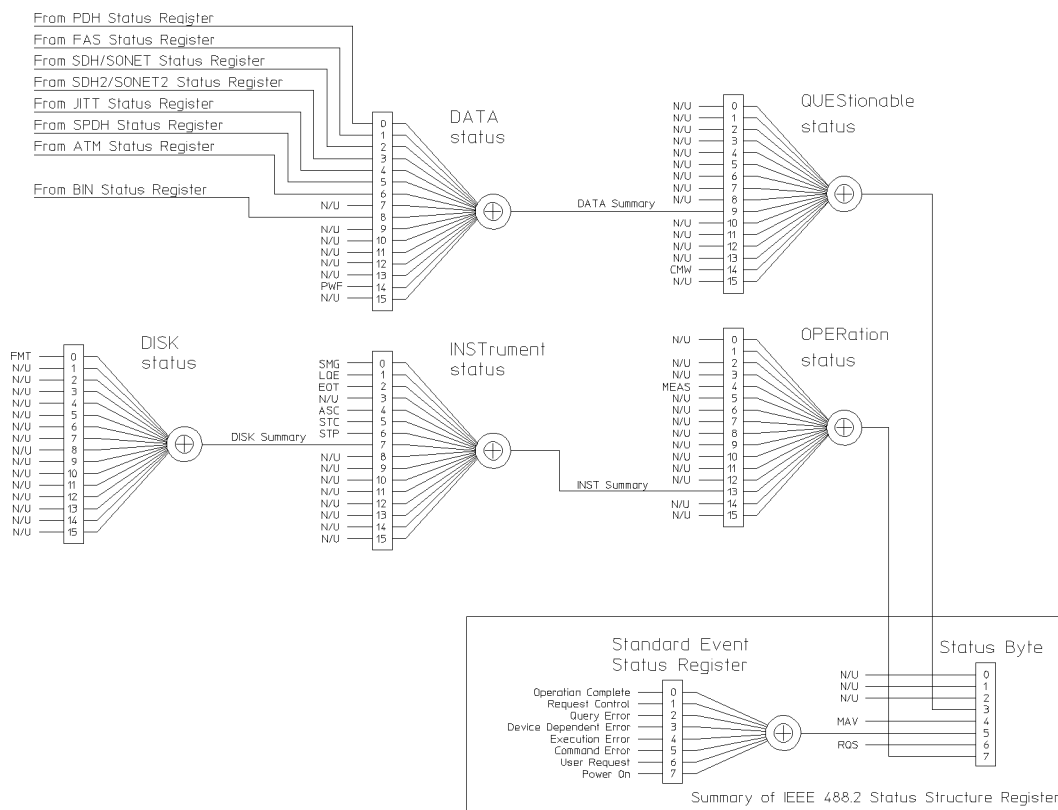

Figure 8-3 Status Registers Relationship 2

Status Reporting



The use of Bit 15 is not allowed since some controllers may have difficulty reading a 16 bit unsigned integer. The value of this bit shall always be 0.

Figure 8-4 Status Registers Relationship 3

Variations in BINARY Input to DATA Status Register

NOTE

On 37717C instruments with Firmware Revision Numbers below A.01.05, The input to the DATA Status Register from the BINARY Status Register is DB7. The Firmware Revision Number is shown on the **OTHER** **REMOTE / PRINTER** display

Status Reporting

Programmed Status Reporting

When a condition is detected, a summary bit is generated by the Status Register which detects the condition. The summary bit in most cases passes through other Status Registers before affecting the Status Byte. These other Status Registers also generate a summary bit, therefore to report a condition requires the setting of the Event Enable Register mask in all registers in the chain.

When implementing status reporting into your programming, consider the following with reference to the Status Registers Relationship diagram, Figures 8-2 to 8-4:

Programming Interrupts

1) Define which conditions you want reported. To do this, set the Event Enable Register mask of the Status Register that first detects the defined conditions. Set the Event Enable Register mask of all subsequent Status Registers between the reporting Status Register and the Status Byte. Using an example from the PDH Status Register :

AIS + Pattern Sync Loss

:STAT:PDH :ENAB 6	Set the PDH event enable register to summarize for AIS (4) + PSL (2)
:STAT:PDH :PTR 6;NTR 0	Transition filter passes positive transitions bits 1 and 2.
:STAT:DATA:ENAB 1	Set the DATA event enable register to summarize for PDH(1)
:STAT:DATA:PTR 1;NTR 0	Transition filter passes positive transitions bit 0.
:STAT:QUES:ENAB 512	Set the QUES event enable register to summarize for DATA(512)
:STAT:QUES:PTR 512;NTR 0	Transition filter passes positive transitions bit 9.

2) If you are implementing a service request/serial poll operation, set the mask of the Status Byte, for example :

***SRE 40** QUES summary + Standard Event summary

The Status Byte register will initiate a service request (RQS) when either of the masked conditions are detected.

Status Reporting

Interpreting Interrupts

1) Check the content of the Status Byte register using the service request/serial poll operation (SPOLL) or by issuing the *STB? common capabilities command, for example :

***STB?** Returns 8 - QUES summary

2) If a condition has been detected, determine which Status Register is responsible for issuing the summary bit, then use the appropriate STATus commands to interrogate the appropriate registers, for example :

:STAT:QUES:EVEN Returns 512 - DATA summary

:STAT:DATA:EVEN? Returns 1 - PDH summary

:STAT:SDH :EVEN? Returns 6 - AIS (4) + PSL (2)

The interrogation of the status byte and status registers reveals that the cause of the interrupt was Unavailability and Pattern Synchronization Loss.

Example Program

```
10 ! Program Name : 21SRQ_DEMO
20 !
30 ! Program to illustrate the use of the Service Request Routine
31 ! in the HP 37717C .
40 ! Written by George Hossack (QTD Product Support) 7-12-93
50 !
60 ! The program starts a 10 second BER measurement on the HP 37717C
70 ! then continually reads and displays the HP 37717C Short-Term
80 ! BER until a Service Request is received from the HP 37717C .
90 ! When this happens, the Controller will suspend current activity
100 ! and read registers to determine the cause of the SRQ.
110 ! The maskable registers are set in the program to generate SRQ at
120 ! end of a measurement or when an HP 37717C Alarm condition occurs.
130 ! If the SRQ is found to be caused by End of Measurement then the
```

Status Reporting

```
140 ! the program will read and print the measurement result before
150 ! continuing to read and display the received Short-Term BER.
160 ! If the SRQ is found to be caused by a masked alarm condition then
170 ! the program will read and print the alarm status then stop as it
180 ! is invalid to return results when a recognized Alarm condition
190 ! exists.
191 !
200 PRINT CHR$(12) !Clear screen
210 PRINT TABXY(27,1);"Service Request - Demo Program"
220 !
230 COM Hp37717          !Common variable(s)
240 Hp37717=705         ! assign variable to default address
250 CALL Init_instr     ! Sub to initialize the 37717C
260 !
270 CALL Config_regs_14 ! Sub to configure 37717 regs for SRQ
280 !
290 ON INTR 7 CALL Read_stat_byte ! Specify interrupt routine
300 !
310 CALL Tx_setup       ! Sub to set up 37717C Transmitter
320 !
330 CALL Rx_setup       ! Sub to set up 37717C Receiver
340 !
350 CALL Results_setup  ! Sub to setup results display
360 !
370 OUTPUT Hp37717;"*CLS" ! Clear any existing SRQ/ Remote errors
380 WAIT 3
390 ENABLE INTR 7;2     ! Enable computer to recognize interrupt
400 !
```

Status Reporting

```
410 CALL Run_meas
420 !
430 CALL Read_short_rslt
440 END
450 !
460 !
470 !
480 !
490 SUB Config_regs_14
500 ! This sub sets up the conditions for generating an SRQ.
510 ! In this case, an SRQ will occur when Signal Loss or Pattern Loss
520 ! alarms are detected, but NOT Errors or AIS Alarms.
530 ! An SRQ is also set to occur at the end of the Measurement period.
540 !
550 !
560 COM Hp37717
570 !OUTPUT Hp37717;"*CLS"      ! Clear any existing SRQ/Remote errors
580 !
590 OUTPUT Hp37717;" :STAT:PDH:PTR 263;NTR 0"
600 ! Set the Transition Filter to pass positive transitions in
610 ! Bits 0,1,2,8 of the PDH Register
620 !
630 OUTPUT Hp37717;" :STAT:PDH:ENAB 263"
640 !Enable UAV,LOF,AIS,PSL and LOS bits in the PDH status register
650 !to set the telecom summary bit in the Data status register
660 !on occurrence of any of these events.
670 !
680 OUTPUT Hp37717;" :STAT:DATA:PTR 1;NTR 0"
```

Status Reporting

690 ! Set the Transition Filter to pass positive transitions in Bit 0
700 !of the Data Status register.
710 OUTPUT Hp37717;".STAT:DATA:ENAB 1"
720 !Enable the PDH data bit in the Data Status register to set
730 !the data summary bit in the Questionable status register
740 !
750 !
760 OUTPUT Hp37717;".STAT:QUES:PTR 512;NTR 0"
770 !Set the transition filter to pass positive transitions in bit 9 of
780 !the Questionable status register
790 OUTPUT Hp37717;".STAT:QUES:ENAB 512"
800 !Enable the data summary bit in the Questionable status register
810 !to set the questionable data summary bit in the status byte
820 !
830 !
840 !
850 OUTPUT Hp37717;".STAT:INST:PTR 4;NTR 0"
860 ! Set the Transition Filter to pass positive transitions in Bit 4
870 ! (End of Test) in the Instrument Status Register
880 OUTPUT Hp37717;".STAT:INST:ENAB 4"
890 !Enable the EOT data bit in the Instrument Status register to set
900 !the data summary bit in the Operation status register
910 !
920 !
930 OUTPUT Hp37717;".STAT:OPER:PTR 8192;NTR 0"
940 !Set the transition filter to pass positive transitions in bit 13
950 !of the Operation status register
960 OUTPUT Hp37717;".STAT:OPER:ENAB 8192"

Status Reporting

```
970 !Enable the instrument summary bit in Operation status register
980 !to set the Operation register summary bit in the status byte
990 !
1000 !
1010 OUTPUT Hp37717;"*SRE 200"
1020 !Set the SRQ mask to cause an SRQ on occurrence of Bit 3 (Ques Reg)
1030 !Bit 6 (RQS) or 7 (Oper reg) being set in the Status byte.
1040 !
1050 !
1060 SUBEND
1070 !
1080 SUB Read_stat_byte
1090 !This subroutine reads the Telecom status register to determine the
1100 !reason(s) for the SRQ.
1110 COM Hp37717
1120 BEEP 700,5
1130 DISP "SRQ detected"
1140 WAIT 1 ! allow time for registers to be updated
1150 DISP
1160 Intr_check=SPOLL(Hp37717) ! Interrogate Primary Status Byte register
1170 ! using Serial Poll method - returns value Intr_check
1180 ! DISP "interrupt check number is ";Intr_check
1190 SELECT Intr_check ! read the value of Primary Status Byte to see
1200 ! cause of interrupt
1201 !
1210 CASE 0 ! interrupt from unspecified device
1220 PRINT CHR$(12) !Clear screen
1229 PRINT TABXY(20,10);"The Controller has received an interrupt from"
```

Status Reporting

```
1230 PRINT TABXY(20,11);"Remove all unspecified equipment from HP-IB"  
1231 STOP  
1232 !  
1240 CASE 192 ! End of Test Period (rqs[64]+oper[128])  
1250 CALL Read_meas_rslt ! measurement has ended, so read back result.  
1260 !  
1270 CASE 72,200 ! masked Alarm condition has occurred (with EOT?)  
1280 CALL Read_pdh_reg  
1290 !  
1300 CASE ELSE  
1305 PRINT TABXY(20,10);"The Controller has received an unspecified"  
1310 PRINT TABXY(20,11);"interrupt from the HP 37717C - check cause"  
1311 STOP  
1312 !  
1320 END SELECT  
1330 SUBEND  
1340 !  
1350 !  
1360 SUB Init_instr  
1370 ! sub to initialize the 37717C  
1380 !  
1390 !  
1400 COM Hp37717  
1410 DISP "Initializing HP37717C " !  
1420 OUTPUT Hp37717;"*CLS" ! Clear any existing SRQ/Remote errors  
1430 WAIT 2 ! allow time for initialization  
1440 OUTPUT Hp37717;"*RST" ! set instrument to default settings  
1450 WAIT 2 ! allow time for initialization
```

Status Reporting

1460 DISP
1470 SUBEND
1480 !
1490 !
1500 SUB Tx_setup
1510 !
1520 !sub to setup the 37717C transmitter
1530 COM Hp37717 !Common variable(s)
1540 OUTPUT Hp37717;"OUTP:TEL:PDH:RATE M2"
1550 OUTPUT Hp37717;"OUTP:TEL:PDH:CODE HDB3"
1560 !OUTPUT Hp37717;"OUTP:TEL:PDH:LEV UNB"
1570 ! Set up PDH Output conditions
1580 !
1590 !
1600 OUTPUT Hp37717;"INST:COUP RTTX"
1610 ! Setup Instrument Subsystem
1620 !
1630 !
1640 OUTPUT Hp37717;"SOUR:DATA:TEL:SOUR PDH"
1650 !OUTPUT Hp37717;"SOUR:DATA:TEL:ERR:BIT RATE"
1660 OUTPUT Hp37717;"SOUR:DATA:TEL:PDH:PAYL:PATT PRBS23"
1670 ! Setup transmit (Source) conditions
1680 !
1690 !
1700 SUBEND
1710 !
1720 !
1730 SUB Rx_setup

Status Reporting

1740 !
1750 !sub to setup the 37717C Receiver
1760 COM Hp37717 !Common variable(s)
1770 ! Use default
1780 SUBEND
1790 !
1800 !
1810 SUB Results_setup
1820 !
1830 ! Sub to setup the Results page
1840 COM Hp37717 !Common variable(s)
1850 OUTPUT Hp37717;"SENS:DATA:TEL:TEST:TYPE SING"
1860 OUTPUT Hp37717;"SENS:DATA:TEL:TEST:PER 10s" !Set Test Period
1870 !
1880 SUBEND
1890 !
1900 !
1910 SUB Run_meas
1920 !
1930 ! Sub to start and run the measurement
1940 COM Hp37717 !Common variable(s)
1950 !
1960 OUTPUT Hp37717;"SENS:DATA:TEL:TEST ON"
1970 SUBEND
1980 !
2110 SUB Read_meas_rslt
2120 !
2130 ! Sub to read back the 37717C result

Status Reporting

```
2140 COM Hp37717          !Common variable(s)
2150 !
2160 WAIT 2
2170 OUTPUT Hp37717;"SENS:DATA? ""ERAT:PDH:BIT""
2180 ! Return the measurement result BER Ratio
2190 ENTER Hp37717;Ber_ratio ! Read back bit error results
2200 PRINT TABXY(27,12); "MEASURED BER RATIO IS ";Ber_ratio
2210 CALL Run_meas
2220 OUTPUT Hp37717;"*CLS"    ! Clear any existing SRQ/Remote errors
2230 WAIT 3
2240 ENABLE INTR 7;2      ! Re-enable computer to recognize interrupt
2250 PRINT TABXY(25,12);"                "
2260 SUBEND
2270 !
2280 !
2290 SUB Read_short_rslt
2300 !
2310 ! Sub to read back the 37717C Short Term Results
2320 WAIT 2 ! Allow time for Short Term results update
2330 !
2340 COM Hp37717          !Common variable(s)
2350 REPEAT
2360 OUTPUT Hp37717;"SENS:DATA? ""ECO:PDH:STER:BIT""
2370 ! Returns the short-term BER Result
2380 ENTER Hp37717;Short_rate ! Readback Short Term BER result
2390 !
2400 PRINT TABXY(27,10);"SHORT-TERM BER COUNT IS ";Short_rate
2410 WAIT 1
```

Status Reporting

```
2420 PRINT TABXY(25,10);"                               "  
2430 !PRINT CHR$(12)  !Clear screen  
2440 UNTIL Forever  
2450 SUBEND  
2460 !  
2470 !  
2480 SUB Read_pdh_reg  
2490 !  
2500 ! Sub to read the PDH register  
2510 COM Hp37717          !Common variable(s)  
2520 !  
2530 !  
2540 OUTPUT Hp37717;".STATUS:PDH:EVENT?"  !Read PDH Status register  
2550 ENTER Hp37717;Alrm_reg_value  
2570 SELECT Alrm_reg_value  
2580 CASE 1,3 ! LOS detected  
2590 PRINT CHR$(12)          !Clear screen  
2600 PRINT TABXY(20,10); "Signal loss has been detected on HP37717C "  
2601 PRINT TABXY(30,11); "Results invalid"  
2602 !  
2610 CASE 2,6 ! PSL detected  
2620 PRINT CHR$(12)          !Clear screen  
2630 PRINT TABXY(20,10); "Pattern Loss has been detected on HP37717C "  
2660 !  
2670 CASE 4 ! AIS  
2680 PRINT CHR$(12)          !Clear screen  
2690 PRINT TABXY(25,10); "AIS has been detected on HP37717C "  
2700 !
```

Status Reporting

```
2710 CASE 256 !LOC
2720 PRINT CHR$(12)          !Clear screen
2730 PRINT TABXY(25,10); "HP37717C VCXO has lost lock - Results invalid"
2740 !
2820 CASE ELSE ! unknown SRQ
2830 PRINT CHR$(12)          !Clear screen
2840 PRINT TABXY(20,10); "A Status Alarm has occurred on the HP 37717C "
2843 PRINT TABXY(20,11); "Check instrument Front Panel to see cause "
2860 END SELECT
2870 !
2871 STOP
2880 !
2920 !
2930 SUBEND
```

Figure 8-5 **Status Reporting Program Example**

Status Reporting

General Information

General Information

General Information

This chapter contains general remote control information.

- **SCPI Overview** - Gives a brief overview of the SCPI Standard.
 - **HP-IB Universal Commands** - Describes the HP-IB Universal commands.
-

SCPI Overview

Standard Commands for Programmable Instruments (SCPI) is a standard of the SCPI Consortium that provides guidelines for remote programming commands for instruments. The goal of SCPI is to reduce Automatic Test Equipment (ATE) program development time. It accomplishes this by providing a consistent programming environment for instrument control and data usage. This programming environment uses defined programming messages, instrument responses, and data formats across all SCPI instruments, regardless of manufacturer.

SCPI is based on two IEEE standards:

- ANSI/IEEE Standard 488.1-1987, *IEEE Standard Digital Interface for Programmable Instrumentation*
- ANSI/IEEE Standard 488.2-1987, *IEEE Standard Codes, Formats, Protocols, and Common Commands. For use with ANSI/IEEE Standard 488.1-1987, IEEE Standard Digital Interface for Programmable Instrumentation*

General Information

HP-IB Universal Commands

The Required Commands perform the most basic remote functions over HP-IB and are common to all HP-IB controllable instruments. The commands are as follows:-

- DEVICE CLEAR
- SERIAL POLL
- REMOTE ENABLE
- LOCAL LOCKOUT
- GO TO LOCAL

Device Clear (CLEAR)

This command will initialize the instrument HP-IB hardware.

The command format using HP 200/300 Series Basic, for example is :

CLEAR 705 (where 7 is the Bus I/O select code and 05 is the device address).

Serial Poll (SPOLL)

A serial poll will retrieve the value of the primary status byte. This byte contains useful information about the current state of the instrument.

for example :

SPOLL(705) (where 7 is the Bus I/O select code and 05 is the device address).

Remote Enable (REMOTE)

The Remote command instructs the instrument to enter the REMOTE state and be ready to accept instructions via HP-IB.

When the HP 37717C receives this command it illuminates the front panel REMOTE indicator.

for example:

REMOTE 705 (where 7 is the Bus I/O select code and 05 is the device address).

General Information

Local Lockout (LOCAL LOCKOUT)

It is recommended that the Local Lockout command is sent after the Remote command. This disables the front panel local key preventing the return to local mode and thus any interference to the instrument settings.

It should always be preceded by the REMOTE command.

for example:

LOCAL LOCKOUT 7 (will configure all the instruments on the bus to the Local Lockout condition.)

NOTE

If the instrument has been set to the LOCAL LOCKOUT condition, then the front panel LOCAL key is disabled. The instrument can only be returned to LOCAL operation by the controller sending the LOCAL command or by cycling power to the instrument.

Local (LOCAL)

The Local command returns the instrument from Remote operation to local front panel control.

for example:

LOCAL 7 or LOCAL 705 (where 7 is the Bus I/O select code and 05 is the device address).

**Application Program
Examples**

Initializing the HP 37717C

The following commands can be used to initialize the HP 37717C. They setup the HP 37717C for remote operation, retrieve various instrument details and couple the transmitter to the receiver.

Table 10-1

HP 37717C Initialization

Comment	SCPI Command	Ref.
Takes the HP 37717C under remote control.	:SYSTem:REMOte	2-48
Reset HP 37717C to Default settings	*RST	2-65
Read SCPI Error Message & Number (+0, "No error")	:SYSTem:ERRor?	2-49
Read Model Name, Serial No., Firmware Rev.etc	*IDN?	2-62
Retrieve HP 37717C Option structure	*OPT?	2-63
Retrieve HP 37717C Serial Number	:SYSTem:SERial?	2-48
Couple the HP 37717C Receiver to the Transmitter	:INSTrument:COUple RTTX	2-8
Return the HP 37717C to local control.	:SYSTem:LOCal	2-48

Setup the HP 37717C PDH Tx (Main Settings)

The following commands can be used to setup the HP 37717C PDH Transmitter to generate a 2Mb/s Unframed signal with a $2^{15}-1$ Inverted PRBS.

Table 10-2

HP 37717C PDH Tx Setup

Comment	SCPI Command	Ref.
Set Tx Output to PDH	SOURce:DATA:TELEcom:SOURce PDH	2-11
Set Tx Line Rate to 2Mb/s	OUTPut:TELEcom:SPDH:RATE M2	3-5
Set Clock Sync to Internal	SOURce:CLOCK:SPDH:SOURce INTERNAL	3-17
Set Termination to 75Ohm Unbalanced	OUTPut:TELEcom:SPDH:BALance UNBalanced	3-7
Set Line Code to HDB3	OUTPut:TELEcom:SPDH:CODE HDB3	3-6
Ensure Frequency Offset is OFF	SOURce:CLOCK:SPDH:M2:FOFFset NONE	3-17
Set Payload Type to Unframed	SOURce:DATA:TELEcom:SPDH:PAYLoad:TYPE UNFRamed	3-24
Set Payload Type to Unstructured	SOURce:DATA:TELEcom:SPDH:PAYLoad:STRucture UNSTRuctured	3-25
Set Pattern to $2^{15}-1$ PRBS	SOURce:DATA:TELEcom:SPDH:PATtern PRBS15	3-23
Set PRBS Polarity to be Inverted	SOURce:DATA:TELEcom:SPDH:PRBS:POLarity INVERTed	3-24

Setup the HP 37717C PDH Rx (Main Settings)

The following commands can be used to setup the HP 37717C PDH Receiver to receive a 2Mb/s Unframed signal with a $2^{15}-1$ Inverted PRBS.

Table 10-3

HP 37717C PDH Rx Setup

Comment	SCPI Command	Ref.
Set Rx Input to PDH	SENSe:DATA:TELEcom:SENSe PDH	2-17
Set Rx Line Rate to 2Mb/s	INPut:TELEcom:SPDH:RATE M2	3-52
Set Termination to 75 Ohm Unbalanced	INPut:TELEcom:SPDH:BALance UNBalanced	3-54
Set Line Code to HDB3	INPut:TELEcom:SPDH:CODE HDB3	3-53
Set the Level to Monitor	INPut:TELEcom:LEVEl MONitor	2-14
Set the Monitor Equalisation ON	INPut:TELEcom:SPDH:EQUalisation ON	3-54
Set the Monitor Equalisation to 26 dB	INPut:TELEcom:SPDH:GAIN DB26	3-54
Set Payload Type to Unframed	SENSe:DATA:TELEcom:SPDH:PAYLoad:TYPE UNFRamed	3-63
Set Payload Type to Unstructured	SENSe:DATA:TELEcom:SPDH:PAYLoad:STRUcture UNSTRUctured	3-64
Set Pattern to $2^{15}-1$ PRBS	SENSe:DATA:TELEcom:SPDH:PATtern PRBS15	3-62
Set PRBS Polarity to be Inverted	SENSe:DATA:TELEcom:SPDH:PRBS:POLarity INVErted	3-63

Setup the HP 37717C PDH Tx (Main & Structured Settings)

The following commands can be used to setup the HP 37717C PDH Transmitter to generate a fully structured DS3 signal with M13 framing.

Table 10-4

HP 37717C PDH Tx Setup

Comment	SCPI Command	Ref.
Setup 'Main Settings'		
Set Tx Output to PDH	SOURCE:DATA:TELEcom:SOURCE PDH	2-11
Set Tx Line Rate to DS3	OUTPut:TELEcom:SPDH:RATE DS3	3-5
Set Clock Sync to Internal	SOURCE:CLOCK:SPDH:SOURCE INTernal	3-17
Set Output Level to DS3-HI	OUTPut:TELEcom:SPDH:LEVel HIGH	3-7
Ensure Frequency Offset is OFF	SOURCE:CLOCK:SPDH:DS3:FOFFset NONE	3-21
Set Payload Type to M13 Framing	SOURCE:DATA:TELEcom:SPDH:PAYLoad:TYPE M13	3-24
Set Payload Type to Unstructured	SOURCE:DATA:TELEcom:SPDH:PAYLoad:STRUcture STRUctured	3-25

Table 10-4**HP 37717C PDH Tx Setup**

Comment	SCPI Command	Ref.
Setup 'Struct'd Settings'		
Set Structured Test Signal to be 56 kb/s timeslot	SOURce:DATA:TELEcom:SPDH:TSIGnal:RATE K56	3-28
Set DS1 Framing to be D4	SOURce:DATA:TELEcom:SPDH:TSIGnal:PAYLoad D4	3-28
Set DS2 Tributary Number to 1	SOURce:DATA:TELEcom:SPDH:TSIGnal:TRIButary:DS2 TRIB1	3-31
Set DS1 Tributary Number to 1	SOURce:DATA:TELEcom:SPDH:TSIGnal:TRIButary:DS1 TRIB1	3-30
Set 56 kb/s Timeslot Number to 1	SOURce:DATA:TELEcom:SPDH:TSIGnal:TSLot:DS1:K56 1	3-31
Set Pattern to 2 ¹¹ -1 PRBS	SOURce:DATA:TELEcom:SPDH:PATTern PRBS11	3-23
Set PRBS Polarity to be Normal	SOURce:DATA:TELEcom:SPDH:PRBS:POLarity NORMal	3-24
Set the non-test Tributary Pattern to AIS	SOURce:DATA:TELEcom:SPDH:TSIGnal:BACKground AIS	3-33
Set DS1 D4 Signaling Bits to be '11'	SOURce:DATA:TELEcom:SPDH:TSLot:SIGNaling:DATA:DS1:D4 "11"	3-34

Setup the HP 37717C PDH Rx (Main & Structured Settings)

The following commands can be used to setup the HP 37717C PDH Receiver to receive a fully structured DS3 signal with M13 framing.

Table 10-5

HP 37717C PDH Rx Setup

Comment	SCPI Command	Ref.
Setup 'Main Settings'		
Set Rx Input to PDH	SENSE:DATA:TELEcom:SENSE PDH	2-17
Set Rx Line Rate to DS3	INPut:TELEcom:SPDH:RATE DS3	3-52
Set the Level to Terminate	INPut:TELEcom:LEVEl TERMinate	2-14
Set Payload Type to M13 Framing	SENSE:DATA:TELEcom:SPDH:PAYLoad:TYPE M13	3-63
Set Payload Type to Unstructured	SENSE:DATA:TELEcom:SPDH:PAYLoad:STRUcture STRUctured	3-64
Setup 'Struct'd Settings'		
Set Structured Test Signal to be 56 kb/s timeslot	SENSE:DATA:TELEcom:SPDH:TSIGnal:RATE K56	3-68
Set DS1 Framing to be D4	SENSE:DATA:TELEcom:SPDH:TSIGnal:PAYLoad D4	3-68
Set DS2 Tributary Number to 1	SENSE:DATA:TELEcom:SPDH:TSIGnal:TRIBUtary:DS2 TRIB1	3-71
Set DS1 Tributary Number to 1	SENSE:DATA:TELEcom:SPDH:TSIGnal:TRIBUtary:DS1 TRIB1	3-70
Set 56 kb/s Timeslot Number to 1	SENSE:DATA:TELEcom:SPDH:TSIGnal:TSLot:DS1:K56 1	3-72
Set Pattern to 2 ¹¹ -1 PRBS	SENSE:DATA:TELEcom:SPDH:PATTern PRBS11	3-62
Set Normal PRBS Polarity	SENSE:DATA:TELEcom:SPDH:PRBS:POLarity NORMal	3-63

Setup the HP 37717C PDH Tx to add Errors & Alarms

The following commands can be used to setup the HP 37717C PDH Transmitter to add errors & alarms.

Table 10-6

HP 37717C PDH Tx Error & Alarm Add

Comment	SCPI Command	Ref.
Select PDH Test Function. See Note 1.	SOURCE:DATA:TELECOM:TFUNCTION PDH	2-12
Set Test Function to be Errors & Alarms	SOURCE:DATA:TELECOM:SPDH:TFUNCTION:TYPE ERROR	3-36
Set Error Add type to Bit	SOURCE:DATA:TELECOM:SPDH:ERROR:TYPE BIT	3-37
Add a single Bit error. Repeat if required.	SOURCE:DATA:TELECOM:SPDH:ERROR:RATE ONCE	3-37
Add a Bit error rate of 1E-4	SOURCE:DATA:TELECOM:SPDH:ERROR:RATE E_4	3-37
Add a Bit error rate of 3.8E-4. See Note 2.	SOURCE:DATA:TELECOM:SPDH:ERROR:RATE:USER 3.8E-4	3-38
Switch Bit error rate OFF	SOURCE:DATA:TELECOM:SPDH:ERROR:RATE NONE	3-37
Generate a 2 Mb/s AIS alarm	SOURCE:DATA:TELECOM:SPDH:M2:ALARM AIS	3-44
Switch alarm OFF	SOURCE:DATA:TELECOM:SPDH:M2:ALARM NONE	3-44

Note 1: If the Tx Output is set to PDH then the PDH Test Function should be selected as shown. However, if the Tx Output is set to SDH then the Test Function selection should be PDHPayload and the corresponding commands used.

Note 2: When selecting a user error rate via SCPI it is not necessary to send any command to switch the selected user rate ON. It is switched ON by default when the user error rate SCPI command is received.

Setup the HP 37717C PDH Rx to perform Bit Error Measurements

The following commands can be used to setup the HP 37717C PDH Receiver to do bit error measurements.

Table 10-7 HP 37717C PDH Rx Bit Error Measurements

Comment	SCPI Command	Ref.
Setup Results Timing Control		
Set Short Term Period to 10 seconds	SENSE:DATA:TELEcom:STERm:PERiod 10s	2-21
Set Test Timing to Single	SENSE:DATA:TELEcom:TEST:TYPE SINGLE	2-20
Set Test Period to 1 minute	SENSE:DATA:TELEcom:TEST:PERiod 1m	2-20
Start gating	SENSE:DATA:TELEcom:TEST ON	2-18
Wait for measurement to complete		
Retrieve Results		
Read back Cumulative Bit Error Count	SENSE:DATA? "ECOUNT:SPDH:BIT"	3-88
Read back Short Term Bit Error Count	SENSE:DATA? "ECOUNT:SPDH:STERm:BIT"	3-86
Read back G.821 Analysis Results	SENSE:DATA? "ESECONDS:SPDH:BIT:ANALYSIS" SENSE:DATA? "EFSECONDS:SPDH:BIT:ANALYSIS" SENSE:DATA? "SESECONDS:SPDH:BIT:ANALYSIS" SENSE:DATA? "UASECONDS:SPDH:BIT:ANALYSIS" SENSE:DATA? "DMINUTES:SPDH:BIT:ANALYSIS"	3-89

Setup the HP 37717C SDH Tx

The following commands can be used to setup the HP 37717C SDH Transmitter to generate a STM-1 Optical signal with a TU-12 PCM31 Framed payload.

Table 10-8

HP 37717C SDH Tx Setup

Comment	SCPI Command	Ref.
Set Tx Output to STM-4/1/0 Optical	<code>SOURCE:DATA:TELECOM:SOURCE OPT4</code>	2-11
Set Tx Line Rate to STM-1 Optical	<code>OUTPUT:TELECOM:OPT4:RATE STM1</code>	4-4
Set Tx Optical Wavelength to be 1310 nm	<code>OUTPUT:TELECOM:OPT4:WAVELENGTH NM1310</code>	4-6
Ensure that Thru Mode is not selected	<code>SOURCE:DATA:TELECOM:SDH:THRUMODE INTERNAL</code>	4-9
Set Clock Sync to Internal	<code>SOURCE:CLOCK:SDH:SOURCE INTERNAL</code>	4-7
Ensure Frequency Offset is OFF	<code>SOURCE:CLOCK:SDH:FOFFSET OFF</code>	4-8
Setup F/G Mappings		
Set AU Layer Selection to AU-4	<code>SOURCE:DATA:TELECOM:SDH:AU:TYPE AU4</code>	4-11
Set TU Layer Selection to TU-12	<code>SOURCE:DATA:TELECOM:SDH:PAYLOAD TU12</code>	4-12
Set the TU-12 Mapping to Asynchronous 2 Mb/s	<code>SOURCE:DATA:TELECOM:SDH:TRIBUTARY:MAPPING ASYNC</code>	4-13
Ensure 2M Payload Offset is 0 ppm	<code>SOURCE:DATA:TELECOM:SDH:PAYLOAD:OFFSET 0</code>	4-17
Set TUG3 Number to 1	<code>SOURCE:DATA:TELECOM:SDH:TUG3 1</code>	4-14
Set TUG2 Number to 1	<code>SOURCE:DATA:TELECOM:SDH:TUG2 1</code>	4-14

Table 10-8**HP 37717C SDH Tx Setup**

Comment	SCPI Command	Ref.
Set TU Number to 1	SOURCE:DATA:TELEcom:SDH:TRIB 1	4-14
Set TU Payload Framing to PCM31	SOURCE:DATA:TELEcom:SDH:PAYLoad:TYPE PCM31	4-15
Set TU Payload Type to Unstructured	SOURCE:DATA:TELEcom:SDH:PAYLoad:STRUCTure UNSTRUCTured	4-15
Set Pattern to 2 ¹⁵ -1 PRBS	SOURCE:DATA:TELEcom:SDH:PAYLoad:PATTERN PRBS15	4-16
Set PRBS Polarity to be Inverted	SOURCE:DATA:TELEcom:SDH:PRBS:POLarity INVERTed	4-17
Setup B/G Mappings		
Set Background TUG3 #2 to TU-12 Mapping	SOURCE:DATA:TELEcom:SDH:TUG3:BACKground:PAYLoad:PATTERN 2,TU12	4-20
Set Background TUG3 #3 to TU-12 Mapping	SOURCE:DATA:TELEcom:SDH:TUG3:BACKground:PAYLoad:PATTERN 3,TU12	4-20
Set Pattern in Background TU-12's within TUG3 #1 to be "1100" Word	SOURCE:DATA:TELEcom:SDH:PRIMARY:BACKground:PAYLoad:PATTERN P1100	4-20

Setup the HP 37717C SDH Rx

The following commands can be used to setup the HP 37717C SDH Receiver to receive a STM-4 Optical signal with a TU-12 Unframed payload.

Table 10-9

HP 37717C SDH Rx Setup

Comment	SCPI Command	Ref.
Set Rx Input to STM-4/1/0 Optical	SENSE:DATA:TELEcom:SENSe OPT4	2-17
Set Rx Line Rate to STM-4 Optical	INPut:TELEcom:OPT4:RATE STM4	4-64
Set AU Layer Selection to AU-4	SENSE:DATA:TELEcom:SDH:AU:TYPE AU4	4-68
Set TU Layer Selection to TU-12	SENSE:DATA:TELEcom:SDH:PAYLoad TU12	4-68
Set the TU-12 Mapping to Asynchronous 2 Mb/s	SENSE:DATA:TELEcom:SDH:TRIButary:MAPPING ASYNc	4-69
Set STM-1 Number Under Test to 1	SENSE:DATA:TELEcom:SDH:VC4 1	4-67
Set TUG3 Number to 1	SENSE:DATA:TELEcom:SDH:TUG3 1	4-70
Set TUG2 Number to 1	SENSE:DATA:TELEcom:SDH:TUG2 1	4-70
Set TU Number to 1	SENSE:DATA:TELEcom:SDH:TRIB 1	4-71
Set TU Payload to be Unframed	SENSE:DATA:TELEcom:SDH:PAYLoad:TYPE UNFRamed	4-71
Set TU Payload Type to Unstructured	SENSE:DATA:TELEcom:SDH:PAYLoad:STRUcture UNSTRUctured	4-72
Set Pattern to 2 ¹⁵ -1 PRBS	SENSE:DATA:TELEcom:SDH:PAYLoad:PATTern PRBS15	4-72
Set PRBS Polarity to be Inverted	SENSE:DATA:TELEcom:SDH:PRBS:POLarity INVERTed	4-74

Setup the HP 37717C SDH Tx to add Errors & Alarms

The following commands can be used to setup the HP 37717C SDH Transmitter to generate errors and alarms using the SDH Test Function.

Table 10-10

HP 37717C SDH Tx Error & Alarm Add

Comment	SCPI Command	Ref.
Select SDH Test Function	SOURCE:DATA:TELEcom:TFUNCTION SDH	2-12
Set Test Function to be Errors & Alarms	SOURCE:DATA:TELEcom:SDH:TFUNCTION:TYPE ERROR	4-36
Set Error Add type to B3 Path BIP	SOURCE:DATA:TELEcom:SDH:ERROR:TYPE PBIP	4-36
Add a single B3 error. Repeat if required.	SOURCE:DATA:TELEcom:SDH:ERROR:RATE ONCE	4-37
Add a B3 error rate of 1E-4	SOURCE:DATA:TELEcom:SDH:ERROR:RATE E_4	4-37
Switch B3 error rate OFF	SOURCE:DATA:TELEcom:SDH:ERROR:RATE NONE	4-37
Generate a MS FERF alarm	SOURCE:DATA:TELEcom:SDH:ALARM MSRD1	4-41
Switch alarm OFF	SOURCE:DATA:TELEcom:SDH:ALARM NONE	4-41

Setup the HP 37717C SDH Tx Overhead Bytes

The following commands can be used to setup the HP 37717C SDH Transmitter Overhead bytes. It is assumed that a STM-4 signal is selected.

Table 10-11

HP 37717C SDH Tx Overhead Setup

Comment	SCPI Command	Ref.
Set the Overhead bytes to their default values	SOURCE:DATA:TELEcom:SDH:OVERhead:DEFault	4-23
Update the D1 byte in STM-1 #1	SOURCE:DATA:TELEcom:SDH:OVERhead:DATA 1,1,D1,"11111111"	4-23
Update the M1 byte in STM-1 #3	SOURCE:DATA:TELEcom:SDH:OVERhead:DATA:HEXadecimal 3,1,M1,"FF"	4-24
Update F2 byte in the VC-4 POH of the selected STM-1	SOURCE:DATA:TELEcom:SDH:POVerhead:DATA F2,"11111111"	4-25
Update J1 trace in VC-4 POH of selected STM-1 to be HP37717C Test string	SOURCE:DATA:TELEcom:SDH:POVerhead:J1:PATtern TEST	4-26
Update F2 byte in VC-3 POH of selected STM-1	SOURCE:DATA:TELEcom:SDH:TRIButary:POVerhead:DATA F2,"11111111"	4-28
Update J1 trace in VC-3 POH of selected STM-1 to be HP37717C Test string	SOURCE:DATA:TELEcom:SDH:TRIButary:POVerhead:J1:PATtern TEST	4-29

Setup the HP 37717C SDH Tx for Overhead Byte Sequencing

The following commands can be used to setup the HP 37717C SDH Transmitter to generate an Overhead byte sequence. It is assumed that a STM-4 signal is selected.

Table 10-12

HP 37717C SDH Tx Overhead Sequence

Comment	SCPI Command	Ref.
Select SDH Test Function.	SOURCE:DATA:TELECOM:TFUNCTION SDH	2-12
Set Test Function to be Overhead Sequences	SOURCE:DATA:TELECOM:SDH:TFUNCTION:TYPE SEQUENCE	4-36
Set Sequence Mode to be Repeat Run	SOURCE:DATA:TELECOM:SDH:SEQUENCE:MODE REPEAT	4-49
Select J0 Byte in RSOH	SOURCE:DATA:TELECOM:SDH:SEQUENCE:OHBYTE J0	4-50
Set Sequence byte values to "00","01","02","03","04"	SOURCE:DATA:TELECOM:SDH:SEQUENCE:DATA A, "00" SOURCE:DATA:TELECOM:SDH:SEQUENCE:DATA B, "01" SOURCE:DATA:TELECOM:SDH:SEQUENCE:DATA C, "02" SOURCE:DATA:TELECOM:SDH:SEQUENCE:DATA D, "03" SOURCE:DATA:TELECOM:SDH:SEQUENCE:DATA E, "04"	4-51
Set the Sequence order to be A,B,C,D,E	SOURCE:DATA:TELECOM:SDH:SEQUENCE:ORDER A,B,C,D,E	4-52
Set the Frame Count for each value to be 10	SOURCE:DATA:TELECOM:SDH:SEQUENCE:FCOUNT 1,10 SOURCE:DATA:TELECOM:SDH:SEQUENCE:FCOUNT 2,10 SOURCE:DATA:TELECOM:SDH:SEQUENCE:FCOUNT 3,10 SOURCE:DATA:TELECOM:SDH:SEQUENCE:FCOUNT 4,10 SOURCE:DATA:TELECOM:SDH:SEQUENCE:FCOUNT 5,10	4-52
Start Sequence	SOURCE:DATA:TELECOM:SDH:SEQUENCE START	4-49

Perform HP 37717C SDH Rx Measurements

The following commands can be used to setup the HP 37717C SDH Receiver to perform B3 measurements.

Table 10-13

HP 37717C SDH Rx Measurements

Comment	SCPI Command	Ref.
Setup Results Timing Control		
Set Short Term Period to 10 seconds	SENSE:DATA:TELEcom:STERm:PERiod 10s	2-21
Set Test Timing to Single	SENSE:DATA:TELEcom:TEST:TYPE SINGLE	2-20
Set Test Period to 1 minute	SENSE:DATA:TELEcom:TEST:PERiod 1m	2-20
Start gating	SENSE:DATA:TELEcom:TEST ON	2-18
Wait for measurement to complete		
Retrieve Results		
Read back Cumulative B3 Error Count	SENSE:DATA? "ECOUNT:SDH:PBIP"	4-89
Read back Short Term B3 Error Count	SENSE:DATA? "ECOUNT:SDH:STERm:PBIP"	4-88
Read back some G.826 Analysis Results	SENSE:DATA? "ESECONDS:SDH:PBIP:ANALYSIS" SENSE:DATA? "SECONDS:SDH:PBIP:ANALYSIS" SENSE:DATA? "UASECONDS:SDH:PBIP:ANALYSIS"	4-92

Setup the HP 37717C SDH Rx to retrieve Overhead Monitor Bytes

The following commands can be used to retrieve the HP 37717C SDH Receiver's Overhead Monitor byte values.

Table 10-14 **HP 37717C SDH Rx Overhead Monitor**

Comment	SCPI Command	Ref.
Retrieve the D1 byte in STM-1 #1	FETCh:SCALAr:DATA:TELEcom:SDH:OVERhead? 1,1,D1	4-101
Retrieve the M1 byte in STM-1 #3	FETCh:SCALAr:DATA:TELEcom:SDH:OVERhead? 3,1,M1	4-101
Retrieve F2 byte in VC-4 POH of selected STM-1	FETCh:SCALAr:DATA:TELEcom:SDH:POVerhead? F2	4-102
Retrieve J1 trace in VC-4 POH of selected STM-1	FETCh:STRing:DATA:TELEcom:SDH:J1?	4-99
Fetch F2 byte in VC-3 POH of selected STM-1	FETCh:SCALAr:DATA:TELEcom:SDH:TRIButary:POVerhead? F2	4-102
Fetch J1 trace in VC-3 POH of selected STM-1	FETCh:STRing:DATA:TELEcom:SDH:TRIButary:J1?	4-100

Setup the HP 37717C SDH Rx to perform Overhead Byte Capture

The following commands can be used to setup the HP 37717C SDH Receiver to capture selected Overhead bytes.

Table 10-15 **HP 37717C SDH Rx Overhead Byte Capture**

Comment	SCPI Command	Ref.
Select SDH Test Function.	<code>SENSE:DATA:TELEcom:TFUNCTION SDH</code>	2-18
Set Test Function to be Overhead Sequences	<code>SENSE:DATA:TELEcom:SDH:TFUNCTION:TYPE OCAPture</code>	4-76
Select J0 Byte for Sequence Capture	<code>SENSE:DATA:TELEcom:SDH:OCAPture:OHBYte J0</code>	4-77
Set Overhead Capture to trigger on value.	<code>SENSE:DATA:TELEcom:SDH:OCAPture:TRIGger ON</code>	4-78
Set Overhead Capture trigger value to "02"	<code>SENSE:DATA:TELEcom:SDH:OCAPture:TRIGger:PATtern "02"</code>	4-79
Start Overhead Capture	<code>SENSE:DATA:TELEcom:SDH:OCAPture START</code>	4-76
Retrieve Overhead Capure data	<code>FETCh:ARRay:DATA:TELEcom:SDH:OCAPture? 16</code>	4-114

Setup the HP 37717C SONET Tx

The following commands can be used to setup the HP 37717C SONET Transmitter to generate a OC-3 Optical signal with a VT-2 PCM31 Framed payload.

Table 10-16

HP 37717C SONET Tx Setup

Comment	SCPI Command	Ref.
Set Tx Output to OC-12/3/1 Optical	<code>SOURCE:DATA:TELECOM:SOURCE OC12</code>	2-11
Set Tx Line Rate to OC-3 Optical	<code>OUTPUT:TELECOM:OC12:RATE OC3</code>	5-4
Set Tx Optical Wavelength to be 1310 nm	<code>OUTPUT:TELECOM:OC12:WAVELENGTH NM1310</code>	5-4
Ensure that Thru Mode is not selected	<code>SOURCE:DATA:TELECOM:SONET:THRUMODE INTERNAL</code>	5-9
Set Clock Sync to Internal	<code>SOURCE:CLOCK:SONET:SOURCE INTERNAL</code>	5-7
Ensure Frequency Offset is OFF	<code>SOURCE:CLOCK:SONET:FOFFSET OFF</code>	5-8
Setup F/G Mappings		
Set SPE Layer Selection to STS-1	<code>SOURCE:DATA:TELECOM:SONET:SPE:TYPE STS1</code>	5-11
Set VT Layer Selection to VT-2	<code>SOURCE:DATA:TELECOM:SONET:PAYLOAD VT2</code>	5-12
Set the VT-2 Mapping to Asynchronous 2 Mb/s	<code>SOURCE:DATA:TELECOM:SONET:TRIBUTARY:MAPPING ASYNC</code>	5-13
Ensure 2M Payload Offset is 0 ppm	<code>SOURCE:DATA:TELECOM:SONET:PAYLOAD:OFFSET 0</code>	5-17
Set STS-1 Number to 1	<code>SOURCE:DATA:TELECOM:SONET:STS1 1</code>	5-12
Set VT Group Number to 1	<code>SOURCE:DATA:TELECOM:SONET:VTGROUP 1</code>	5-13

Table 10-16

HP 37717C SONET Tx Setup

Comment	SCPI Command	Ref.
Set VT Number to 1	SOURce:DATA:TELEcom:SONet:TRIButary 1	5-14
Set VT Payload Framing to PCM31	SOURce:DATA:TELEcom:SONet:PAYLoad:TYPE PCM31	5-14
Set VT Payload Type to Unstructured	SOURce:DATA:TELEcom:SONet:PAYLoad:STRUcture UNSTRUctured	5-15
Set Pattern to 2 ¹⁵ -1 PRBS	SOURce:DATA:TELEcom:SONet:PAYLoad:PATTern PRBS15	5-15
Set PRBS Polarity to be Inverted	SOURce:DATA:TELEcom:SONet:PRBS:POLarity INVerted	5-16
Setup B/G Mappings		
Set Background STS-1 #2 to VT-2 Mapping	SOURce:DATA:TELEcom:SONet:STS1:BACKground:PAYLoad:PATTern 2,VT2	5-19
Set Background STS-1 #3 to VT-2 Mapping	SOURce:DATA:TELEcom:SONet:STS1:BACKground:PAYLoad:PATTern 3,VT2	5-19
Set Pattern in Background VT-2's within STS-1 #1 to be "1100" Word	SOURce:DATA:TELEcom:SONet:PRIMary:BACKground:PAYLoad:PATTern P1100	5-19

Setup the HP 37717C SONET Rx

The following commands can be used to setup the HP 37717C SONET Receiver to receive a OC-12 Optical signal with a VT-2 Unframed payload.

Table 10-17

HP 37717C SONET Rx Setup

Comment	SCPI Command	Ref.
Set Rx Input to OC-12/3/1 Optical	SENSe:DATA:TELEcom:SENSe OC12	2-17
Set Rx Line Rate to OC-12 Optical	INPut:TELEcom:OC12:RATE OC12	5-60
Set SPE Layer Selection to STS-1	SENSe:DATA:TELEcom:SONet:SPE:TYPE STS1	5-64
Set VT Layer Selection to VT-2	SENSe:DATA:TELEcom:SONet:PAYLoad VT2	5-64
Set the VT-2 Mapping to Asynchronous 2 Mb/s	SENSe:DATA:TELEcom:SONet:TRIButary:MAPPING ASYNc	5-65
Set STS-3 Number Under Test to 1	SENSe:DATA:TELEcom:SONet:STS3 1	5-63
Set STS-1 Number to 1	SENSe:DATA:TELEcom:SONet:STS1 1	5-64
Set VT Group Number to 1	SENSe:DATA:TELEcom:SONet:VTGRoup 1	5-66
Set VT Number to 1	SENSe:DATA:TELEcom:SONet:TRIButary 1	5-66
Set VT Payload to be Unframed	SENSe:DATA:TELEcom:SONet:PAYLoad:TYPE UNFRamed	5-67
Set VT Payload Type to Unstructured	SENSe:DATA:TELEcom:SONet:PAYLoad:STRUcture UNSTRUctured	5-67
Set Pattern to 2 ¹⁵ -1 PRBS	SENSe:DATA:TELEcom:SONet:PAYLoad:PATtern PRBS15	5-68
Set PRBS Polarity to be Inverted	SENSe:DATA:TELEcom:SONet:PRBS:POLarity INVERTed	5-69

Setup the HP 37717C SONET Tx to add Errors & Alarms

The following commands can be used to setup the HP 37717C SONET Transmitter to generate errors and alarms using the SONET Test Function.

Table 10-18

HP 37717C SONET Tx Error & Alarm Add

Comment	SCPI Command	Ref.
Select SONET Test Function	<code>SOURCE:DATA:TELEcom:TFUNCTION SONet</code>	2-12
Set Test Function to be Errors & Alarms	<code>SOURCE:DATA:TELEcom:SONet:TFUNCTION:TYPE ERROR</code>	5-32
Set Error Add type to CV-P (B3)	<code>SOURCE:DATA:TELEcom:SONet:ERROR:TYPE CVP</code>	5-32
Add a single CV-P error. Repeat if required.	<code>SOURCE:DATA:TELEcom:SONet:ERROR:RATE ONCE</code>	5-33
Add a CV-P error rate of 1E-4	<code>SOURCE:DATA:TELEcom:SONet:ERROR:RATE E_4</code>	5-33
Switch CV-P error rate OFF	<code>SOURCE:DATA:TELEcom:SONet:ERROR:RATE NONE</code>	5-33
Generate a Line FERF (RDI-L) alarm	<code>SOURCE:DATA:TELEcom:SONet:ALARM RDIL</code>	5-37
Switch alarm OFF	<code>SOURCE:DATA:TELEcom:SONet:ALARM NONE</code>	5-37

Setup the HP 37717C SONET Tx Overhead Bytes

The following commands can be used to setup the HP 37717C SONET Transmitter Overhead bytes. It is assumed that a OC-12 signal is selected. .

Table 10-19

HP 37717C SONET Tx Overhead Setup

Comment	SCPI Command	Ref.
Set the Overhead bytes to their default values	<code>SOURCE:DATA:TELECOM:SONET:OVERHEAD:DEFAULT</code>	4-21
Update the D1 byte in STS-3 #1	<code>SOURCE:DATA:TELECOM:SONET:OVERHEAD:DATA 1,1,D1,"11111111"</code>	4-21
Update the M1 byte in STS-3 #3	<code>SOURCE:DATA:TELECOM:SONET:OVERHEAD:DATA:HEXADecimal 3,1,M1,"FF"</code>	4-22
Update F2 byte in the POH of the selected STS-3	<code>SOURCE:DATA:TELECOM:SONET:POVERHEAD:DATA F2,"11111111"</code>	4-23
Update J1 trace in POH of selected STS-3 to be HP37717C Test string	<code>SOURCE:DATA:TELECOM:SONET:POVERHEAD:J1:PATTERN TEST</code>	4-24

Setup the HP 37717C SONET Tx for Overhead Byte Sequencing

The following commands can be used to setup the HP 37717C SONET Transmitter to generate an Overhead byte sequence. It is assumed that an OC-12 signal is selected. .

Table 10-20 **HP 37717C SONET Tx Overhead Sequence**

Comment	SCPI Command	Ref.
Select SONET Test Function.	SOURce:DATA:TELEcom:TFUNction SONet	2-12
Set Test Function to be Overhead Sequences	SOURce:DATA:TELEcom:SONet:TFUNction:TYPE SEquence	5-32
Set Sequence Mode to be Repeat Run	SOURce:DATA:TELEcom:SONet:SEquence:MODE REPeat	5-45
Select J0 Byte in SOH	SOURce:DATA:TELEcom:SONet:SEquence:OHBYte J0	5-46
Set Sequence byte values to "00","01","02","03","04"	SOURce:DATA:TELEcom:SONet:SEquence:DATA A, "00" SOURce:DATA:TELEcom:SONet:SEquence:DATA B, "01" SOURce:DATA:TELEcom:SONet:SEquence:DATA C, "02" SOURce:DATA:TELEcom:SONet:SEquence:DATA D, "03" SOURce:DATA:TELEcom:SONet:SEquence:DATA E, "04"	5-47
Set the Sequence order to be A,B,C,D,E	SOURce:DATA:TELEcom:SONet:SEquence:ORDER A,B,C,D,E"	5-47
Set the Frame Count for each value to be 10	SOURce:DATA:TELEcom:SONet:SEquence:FCOunt 1,10 SOURce:DATA:TELEcom:SONet:SEquence:FCOunt 2,10 SOURce:DATA:TELEcom:SONet:SEquence:FCOunt 3,10 SOURce:DATA:TELEcom:SONet:SEquence:FCOunt 4,10 SOURce:DATA:TELEcom:SONet:SEquence:FCOunt 5,10	5-48
Start Sequence	SOURce:DATA:TELEcom:SONet:SEquence START	5-45

Perform HP 37717C SONET Rx Measurements

The following commands can be used to setup the HP 37717C SONET Receiver to perform B3 measurements. .

Table 10-21

HP 37717C SONET Rx Measurements

Comment	SCPI Command	Ref.
Setup Results Timing Control		
Set Short Term Period to 10 seconds	SENSE:DATA:TELEcom:STERm:PERiod 10s	2-21
Set Test Timing to Single	SENSE:DATA:TELEcom:TEST:TYPE SINGLE	2-20
Set Test Period to 1 minute	SENSE:DATA:TELEcom:TEST:PERiod 1m	2-20
Start gating	SENSE:DATA:TELEcom:TEST ON	2-18
Wait for measurement to complete		
Retrieve Results		
Read back Cumulative CV-P Error Count	SENSE:DATA? "ECOUNT:SONet:CVP"	5-83
Read back Short Term CV-P Error Count	SENSE:DATA? "ECOUNT:SONet:STERm:CVP"	5-82
Read back some G.826 Analysis Results	SENSE:DATA? "ESECONDS:SONet:CVP:ANALYSIS" SENSE:DATA? "SECONDS:SONet:CVP:ANALYSIS" SENSE:DATA? "UASECONDS:SONet:CVP:ANALYSIS"	5-84

Setup the HP 37717C SONET Rx to retrieve Overhead Monitor Bytes

The following commands can be used to retrieve the HP 37717C SONET Receiver's Overhead Monitor byte values. .

Table 10-22 **HP 37717C SONET Rx Overhead Monitor**

Comment	SCPI Command	Ref.
Retrieve the D1 byte in STS-3 #1	<code>FETCh:SCALar:DATA:TELEcom:SONet:OVERhead? 1,1,D1</code>	5-95
Retrieve the M1 byte in STS-3 #3	<code>FETCh:SCALar:DATA:TELEcom:SONet:OVERhead? 3,1,M1</code>	5-95
Retrieve F2 byte in POH of selected STS-3	<code>FETCh:SCALar:DATA:TELEcom:SONet:POVerhead? F2</code>	5-96
Retrieve J1 trace in POH of selected STS-3	<code>FETCh:STRing:DATA:TELEcom:SONet:J1?</code>	5-93

Setup the HP 37717C SONET Rx to perform Overhead Byte Capture

The following commands can be used to setup the HP 37717C SONET Receiver to capture selected Overhead bytes.

Table 10-23

HP 37717C SONET Rx Overhead Byte Capture

Comment	SCPI Command	Ref.
Select SONET Test Function.	<code>SENSE:DATA:TELEcom:TFUNCTION SONet</code>	2-18
Set Test Function to be Overhead Sequences	<code>SENSE:DATA:TELEcom:SONet:TFUNCTION:TYPE OCAPture</code>	5-71
Select J0 Byte for Sequence Capture	<code>SENSE:DATA:TELEcom:SONet:OCAPture:OHBYte J0</code>	5-71
Set Overhead Capture to trigger on value.	<code>SENSE:DATA:TELEcom:SONet:OCAPture:TRIGger ON</code>	5-73
Set Overhead Capture trigger value to "02"	<code>SENSE:DATA:TELEcom:SONet:OCAPture:TRIGger:PATTern "02"</code>	5-73
Start Overhead Capture	<code>SENSE:DATA:TELEcom:SONet:OCAPture START</code>	5-71
Retrieve Overhead Capure data	<code>FETCh:ARRay:DATA:TELEcom:SONet:OCAPture? 16</code>	5-103

Backwards Compatibility

Backwards Compatibility

Backwards Compatibility

If you have written a SCPI program for an earlier revision of the HP 37717C, some SCPI commands may not work with the latest instrument revision. This section lists those command/query pairs which have been changed in such a way that they are incompatible with previously released material.

:SOURCE:DATA:TELEcom:SPDH:PAYLoad:TYPE

The parameter option 'STRUCTURED' has been removed from both command and query. A new command has been created for this alone, :SOURCE:DATA:TELEcom:SPDH:PAYLoad:STRUCTURE.

The corresponding query will no longer return 'STRUCTURED'. To determine if the signal is structured, :SOURCE:DATA:TELEcom:SPDH:PAYLoad:STRUCTURE? must be used.

:SENSe:DATA:TELEcom:SPDH:PAYLoad:TYPE

This command/query pair has been changed in the same manner as the corresponding :SOURCE subsystem command/query pair.

:SOURCE:DATA:TELEcom:SDH:PAYLoad:TYPE

The parameter option 'STRUCTURED' has been removed from both command and query. A new command has been created for this alone, :SOURCE:DATA:TELEcom:SDH:PAYLoad:STRUCTURE. Note that structured payloads are only supported when a structured PDH module is fitted.

The corresponding query will no longer return 'STRUCTURED'. To determine if the signal is structured, :SOURCE:DATA:TELEcom:SDH:PAYLoad:STRUCTURE? must be used.

:SENSe:DATA:TELEcom:SDH:PAYLoad:TYPE

This command/query pair has been changed in the same manner as the corresponding :SOURCE subsystem command/query pair.

Backwards Compatibility

Mixed Backgrounds

The following command/query pair is affected.

:SOURce:DATA:TELEcom:SDH:TUG3:BACKground:PAYLoad[:PATtern]

Before this release all three backgrounds could be programmed and only the two in context at any time would be in effect. The other would be masked by the foreground selection. Now, there are only two background channels, called LO and HI. LO can be channel 1 (if the foreground is not in channel 1) or 2. HI can be channel 2 or 3, depending on which channel is the foreground. Changing which channel is the foreground will change the channel selections of LO and/or HI. The mapping selections and user words associated with HI and LO will be unaffected by such a change, but they may apply to a different channel.

For correct operation, it is recommended that the backgrounds are setup after each change of foreground channel number.

Furthermore, the TU3 background is now always of the user selectable word form instead of merely fixed word for the cases where TU3 was a mixed background. The effect of this is that the parameter UWORD will be converted to TU3. The effect is the same for the command, but the query will return TU3 instead of the previous behavior of returning UWORD.

Backwards Compatibility

SCPI Error Messages

SCPI Error Messages

SCPI Error Messages

The system-defined error/event numbers are chosen on an enumerated ("1 of N") basis. The SCPI defined error/event numbers and the error description portions of the ERRor query response are listed here. The first error/event described in each class (for example, -100, -200, -300, -400) is a "generic" error. In selecting the proper error/event number to report, more specific error/event codes are preferred, and the generic error/event is used only if the others are inappropriate.

No Error

This message indicates that the device has no errors.

No Error

The queue is completely empty. Every error/event in the queue has been read or the queue was purposely cleared by power-on, *CLS, etc.

Command Errors [-199, -100]

An < error/event number > in the range [-199, -100] indicates that an *IEEE 488.2* syntax error has been detected by the instrument's parser. The occurrence of any error in this class should cause the command error bit (bit 5) in the event status register (*IEEE 488.2*, section 11.5.1) to be set. One of the following events has occurred:

- An *IEEE 488.2* system error has been detected by the parser. That is, a controller-to-device message was received which is in violation of the *IEEE 488.2* standard. Possible violations include a data element which violates the device listening formats or whose type is unacceptable to the device.
 - An unrecognized header was received. Unrecognized headers include incorrect device-specific headers and incorrect or not implemented *IEEE 488.2* common commands.
 - A Group Execute Trigger (GET) was entered into the input buffer inside of an
-

SCPI Error Messages

IEEE 488.2 < PROGRAM MESSAGE >.

Events that generate command errors shall not generate execution errors, device-specific errors, or query errors.

-100

Command error

This is the generic syntax error for devices that cannot detect more specific errors. This code indicates only that a Command Error as defined in *IEEE 488.2*, 11.5.1.1.4 has occurred.

-101

Invalid character

A syntactic element contains a character which is invalid for that type; for example, a header containing an ampersand, SETUP&. This error might be used in place of errors -114, -121, -141, and perhaps some others.

-102

Syntax error

An unrecognized command or data type was encountered; for example, a string was received when the device does not accept strings.

-103

Invalid separator

The parser was expecting a separator and encountered an illegal character; for example, the semicolon was omitted after a program message unit, *ESE 1 :OUTP1:TEL:RATE 140 Mb/s

-104

Data type error

The parser recognized a data element different than one allowed; for example, numeric or string data was expected but block data was encountered.

-105

GET not allowed

A Group Execute Trigger was received within a program message (see *IEEE 488.2*, 7.7).

-108

Parameter not allowed

More parameters were received than expected for the header; for example, the *RCL common command only accepts one parameter, so receiving *RCL 0,1 is not allowed.

SCPI Error Messages

- 109 **Missing parameter**
Fewer parameters were received than required for the header; for example, the *ESE common command requires one parameter, so receiving *ESE is not allowed.
- 110 **Command header error**
An error was detected in the header. This error message should be used when the device cannot detect the more specific errors described for errors -111 through -119.
- 111 **Header separator error**
A character which is not a legal header separator was encountered while parsing the header; for example, no white space followed the header, thus *ESE1 is an error.
- 112 **Program mnemonic too long**
The header contains more than twelve characters (see *IEEE 488.2*, 7.6.1.4.1).
- 113 **Undefined header**
The header is syntactically correct, but it is undefined by this specific device; for example, *XYZ is not defined for any device.
- 114 **Header suffix out of range**
Indicates that a non-header character has been encountered in what the parser expects is a header element.
- 120 **Numeric data error**
This error, as well as errors -121 through -129, are generated when parsing a data element which appears to be numeric, including the non-decimal numeric types. This particular error message should be used if the device cannot detect a more specific error.
- 121 **Invalid character in number**
An invalid character for the data type being parsed was encountered; for example, an alpha in a decimal numeric or a “9” in octal data.

SCPI Error Messages

- 123 **Exponent too large**
The magnitude of the exponent was larger than 32000 (see *IEEE 488.2, 7.7.2.4.1*).
- 124 **Too many digits**
The mantissa of a decimal numeric data element contained more than 255 digits excluding leading zeros (see *IEEE 488.2, 7.7.2.4.1*).
- 128 **Numeric data not allowed**
A legal numeric data element was received, but the device does not accept one in this position for the header.
- 130 **Suffix error**
This error, as well as errors –131 through –139, are generated when parsing a suffix. This particular error message should be used if the device cannot detect a more specific error.
- 131 **Invalid suffix**
The suffix does not follow the syntax described in *IEEE 488.2, 7.7.3.2*, or the suffix is inappropriate for this device.
- 134 **Suffix too long**
The suffix contained more than 12 characters (see *IEEE 488.2, 7.7.3.4*).
- 138 **Suffix not allowed**
A suffix was encountered after a numeric element which does not allow suffixes.
- 140 **Character data error**
This error, as well as errors –141 through –149, are generated when parsing a character data element. This particular error message should be used if the device cannot detect a more specific error.
- 141 **Invalid character data**
Either the character data element contains an invalid character or the particular element received is not valid for the header.

SCPI Error Messages

- 144 **Character data too long**
The character data element contains more than twelve characters (see *IEEE 488.2, 7.7.1.4*).
- 148 **Character data not allowed**
A legal character data element was encountered where prohibited by the device.
- 150 **String data error**
This error, as well as errors -151 through -159, are generated when parsing a string data element. This particular error message should be used if the device cannot detect a more specific error.
- 151 **Invalid string data**
A string data element was expected, but was invalid for some reason (see *IEEE 488.2, 7.7.5.2*); for example, an END message was received before the terminal quote character.
- 158 **String data not allowed**
A string data element was encountered but was not allowed by the device at this point in parsing.
- 160 **Block data error**
This error, as well as errors -161 through -169, are generated when parsing a block data element. This particular error message should be used if the device cannot detect a more specific error.
- 161 **Invalid block data**
A block data element was expected, but was invalid for some reason (see *IEEE 488.2, 7.7.6.2*); for example, an END message was received before the length was satisfied.
- 168 **Block data not allowed**
A legal block data element was encountered but was not allowed by the device at this point in parsing.

SCPI Error Messages

–170

Expression error

This error, as well as errors –171 through –179, are generated when parsing an expression data element. This particular error message should be used if the device cannot detect a more specific error.

–171

Invalid expression

The expression data element was invalid (see *IEEE 488.2, 7.7.7.2*); for example, unmatched parentheses or an illegal character.

–178

Expression data not allowed

A legal expression data was encountered but was not allowed by the device at this point in parsing.

–180

Macro error

This error, as well as errors –181 through –189, are generated when defining a macro or executing a macro. This particular error message should be used if the device cannot detect a more specific error.

–181

Invalid outside macro definition

Indicates that a macro parameter placeholder ($\$<number>$) was encountered outside of a macro definition.

–183

Invalid inside macro definition

Indicates that the program message unit sequence, sent with a *DDT or *DMC command, is syntactically invalid (see 10.7.6.3).

–184

Macro parameter error

Indicates that a command inside the macro definition had the wrong number or type of parameters.

SCPI Error Messages

Execution Errors [-299, -200]

An < error/event number > in the range [-299, -200] indicates that an error has been detected by the instrument's execution control block. The occurrence of any error in this class should cause the execution error bit (bit 4) in the event status register (*IEEE 488.2*, section 11.5.1) to be set. One of the following events has occurred:

- A <PROGRAM DATA > element following a header was evaluated by the device as outside of its legal input range or is otherwise inconsistent with the device's capabilities.
- A valid program message could not be properly executed due to some device condition.

Execution errors shall be reported by the device after rounding and expression evaluation operations have taken place. Rounding a numeric data element, for example, shall not be reported as an execution error. Events that generate execution errors shall not generate Command Errors, device-specific errors, or Query Errors.

-200

Execution error

This is the generic syntax error for devices that cannot detect more specific errors. This code indicates only that an Execution Error as defined in *IEEE 488.2*, 11.5.1.1.5 has occurred.

-201

Invalid while in local

Indicates that a command is not executable while the device is in local due to a hard local control (see *IEEE 488.2*, 5.6.1.5); for example, a device with a rotary switch receives a message which would change the switches state, but the device is in local so the message can not be executed.

-202

Settings lost due to rtl

Indicates that a setting associated with a hard local control (see *IEEE 488.2*, 5.6.1.5) was lost when the device changed to LOCS from REMS or to LWLS from RWLS.

-210

Trigger error

SCPI Error Messages

- 211 **Trigger ignored**
- Indicates that a GET, *TRG, or triggering signal was received and recognized by the device but was ignored because of device timing considerations; for example, the device was not ready to respond. Note: a DT0 device always ignores GET and treats *TRG as a Command Error.
- 212 **Arm ignored**
- Indicates that an arming signal was received and recognized by the device but was ignored.
- 213 **Init ignored**
- Indicates that a request for a measurement initiation was ignored as another measurement was already in progress.
- 214 **Trigger deadlock**
- Indicates that the trigger source for the initiation of a measurement is set to GET and subsequent measurement query is received. The measurement cannot be started until a GET is received, but the GET would cause an INTERRUPTED error.
- 215 **Arm deadlock**
- Indicates that the arm source for the initiation of a measurement is set to GET and subsequent measurement query is received. The measurement cannot be started until a GET is received, but the GET would cause an INTERRUPTED error.
- 220 **Parameter error**
- Indicates that a program data element related error occurred. This error message should be used when the device cannot detect the more specific errors described for errors –221 through –229.
- 221 **Setting conflict**
- Indicates that a legal program data element was parsed but could not be executed due to the current device state (see *IEEE 488.2*, 6.4.5.3 and 11.5.1.1.5.)

SCPI Error Messages

- 222 **Data out of range**
- Indicates that a legal program data element was parsed but could not be executed because the interpreted value was outside the legal range as defined by the device (see *IEEE 488.2*, 11.5.1.1.5.)
- 223 **Too much data**
- Indicates that a legal program data element of block, expression, or string type was received that contained more data than the device could handle due to memory or related device-specific requirements.
- 224 **Illegal parameter value**
- Used where exact value, from a list of possibles, was expected.
- 230 **Data corrupt or stale**
- Possibly invalid data; new reading started but not completed since last access.
- 231 **Data questionable**
- Indicates that measurement accuracy is suspect.
- 240 **Hardware error**
- Indicates that a legal program command or query could not be executed because of a hardware problem in the device. Definition of what constitutes a hardware problem is completely device-specific. This error message should be used when the device cannot detect the more specific errors described for errors –241 through –249.
- 241 **Hardware missing**
- Indicates that a legal program command or query could not be executed because of missing device hardware; for example, an option was not installed. Definition of what constitutes missing hardware is completely device-specific.
- 250 **Mass storage error**
- Indicates that a mass storage error occurred. This error message should be used when the device cannot detect the more specific errors described for errors –251 through –259.

SCPI Error Messages

-251

Missing mass storage

Indicates that a legal program command or query could not be executed because of missing mass storage; for example, an option that was not installed. Definition of what constitutes missing mass storage is device-specific.

-252

Missing media

Indicates that a legal program command or query could not be executed because of a missing media; for example, no disk. The definition of what constitutes missing media is device-specific.

-253

Corrupt media

Indicates that a legal program command or query could not be executed because of corrupt media; for example, bad disk or wrong format. The definition of what constitutes corrupt media is device-specific.

-254

Media full

Indicates that a legal program command or query could not be executed because the media was full; for example, there is no room on the disk. The definition of what constitutes a full media is device-specific.

-255

Directory full

Indicates that a legal program command or query could not be executed because the media directory was full. The definition of what constitutes a full media directory is device-specific.

-256

File name not found

Indicates that a legal program command or query could not be executed because the file name on the device media was not found; for example, an attempt was made to read or copy a nonexistent file. The definition of what constitutes a file not being found is device-specific.

-257

File name error

Indicates that a legal program command or query could not be executed because the file name on the device media was in error; for example, an attempt was made to copy to a duplicate file name. The definition of what constitutes a file name error is device-specific.

SCPI Error Messages

- 258 **Media protected**
- Indicates that a legal program command or query could not be executed because the media was protected; for example, the write-protect tab on a disk was present. The definition of what constitutes protected media is device-specific.
- 260 **Expression error**
- Indicates that an expression program data element related error occurred. This error message should be used when the device cannot detect the more specific errors described for errors –261 through –269.
- 261 **Math error in expression**
- Indicates that a syntactically legal expression program data element could not be executed due to a math error; for example, a divide-by-zero was attempted. The definition of math error is device-specific.
- 270 **Macro error**
- Indicates that a macro-related execution error occurred. This error message should be used when the device cannot detect the more specific errors described for errors –271 through –279.
- 271 **Macro syntax error**
- Indicates that a syntactically legal macro program data sequence, according to *IEEE 488.2, 10.7.2*, could not be executed due to a syntax error within the macro definition (see *IEEE 488.2, 10.7.6.3*.)
- 272 **Macro execution error**
- Indicates that a syntactically legal macro program data sequence could not be executed due to some error in the macro definition (see *IEEE 488.2, 10.7.6.3*.)
- 273 **Illegal macro label**
- Indicates that the macro label defined in the *DMC command was a legal string syntax but could not be accepted by the device (see *IEEE 488.2, 10.7.3* and *10.7.6.2*); for example, the label was too long, the same as a common command header, or contained invalid header syntax.

SCPI Error Messages

- 274 **Macro parameter error**
Indicates that the macro definition improperly used a macro parameter placeholder (see *IEEE 488.2*, 10.7.3).
- 275 **Macro definition too long**
Indicates that a syntactically legal macro program data sequence could not be executed because the string or block contents were too long for the device to handle (see *IEEE 488.2*, 10.7.6.1).
- 276 **Macro recursion error**
Indicates that a syntactically legal macro program data sequence could not be executed because the device found it to be recursive (see *IEEE 488.2*, 10.7.6.6).
- 277 **Macro redefinition not allowed**
Indicates that a syntactically legal macro label in the *DMC command could not be executed because the macro label was already defined (see *IEEE 488.2*, 10.7.6.4).
- 278 **Macro header not found**
Indicates that a syntactically legal macro label in the *GMC? query could not be executed because the header was not previously defined.
- 280 **Program error**
Indicates that a downloaded program-related execution error occurred. This error message should be used when the device cannot detect the more specific errors described for errors –281 through –289.
-
- NOTE** A downloaded program is used to add algorithmic capability to a device. The syntax used in the program and the mechanism for downloading a program is device-specific.
-
- 281 **Cannot create program**
Indicates that an attempt to create a program was unsuccessful. A reason for the failure might include not enough memory.

SCPI Error Messages

-282

Illegal program name

The name used to reference a program was invalid; for example, redefining an existing program, deleting a nonexistent program, or in general, referencing a nonexistent program.

-283

Illegal variable name

An attempt was made to reference a nonexistent variable in a program.

-284

Program currently running

Certain operations dealing with programs may be illegal while the program is running; for example, deleting a running program might not be possible.

-285

Program syntax error

Indicates that a syntax error appears in a downloaded program. The syntax used when parsing the downloaded program is device-specific.

-286

Program runtime error

SCPI Error Messages

Query Errors [-399, -300]

An < error/event number > in the range [-399, -300] indicates that the instrument has detected an error which is not a command error, a query error, or an execution error; some device operations did not properly complete, possibly due to an abnormal hardware or firmware condition. These codes are also used for self-test response errors. The occurrence of any error in this class should cause the device-specific error bit (bit 3) in the event status register (IEEE 488.2, section 11.5.1) to be set. The meaning of positive error codes is device-dependent and may be enumerated or bit mapped; the <error message> string for positive error codes is not defined by SCPI and available to the device engineer. Note that the string is not optional; if the designer does not wish to implement a string for a particular error, the null string should be sent (for example 42, " "). The occurrence of any error in this class should cause the device-specific error bit (bit 3) in the event status register (IEEE 488.2, section 11.5.1) to be set. Events that generate device-specific errors shall not generate command errors, execution errors, or query errors; see the other error definitions in this section.

-300

Device-specific error

This is the generic device-dependent error for devices that cannot detect more specific errors. This code indicates only that a Device-Dependent Error as defined in *IEEE 488.2*, 11.5.1.1.6 has occurred.

-310

System error

Indicates that some error, termed “system error” by the device has occurred. This code is device dependent.

-311

Memory error

Indicates that an error was detected in the device’s memory. The scope of this error is device-dependent.

-312

PUD memory lost

Indicates that the protected user data saved by the *PUD command has been lost.

SCPI Error Messages

- 313 **Calibration memory lost**
Indicates that nonvolatile calibration data used by the *CAL? command has been lost.
- 314 **Save/Recall memory lost**
Indicates that the nonvolatile data saved by the *SAV? command has been lost.
- 315 **Configuration memory lost**
Indicates that the nonvolatile data saved by the device has been lost. The meaning of this error is device-specific.
- 330 **Self-test failed**
- 350 **Queue overflow**
A specific code entered into the queue in lieu of the code that caused the error. This code indicates that there is no room in the queue and an error occurred but was not recorded.
- 360 **Communication error**
This is the generic communication error for devices that cannot detect the more specific errors described for errors -361 through -363.
- 361 **Parity error in program message**
Parity bit not correct when data received for example, on a serial port (for example, a baud rate mismatch).
- 362 **Framing error in program message**
A stop bit was not detected when data was received for example, on a serial port.
- 363 **Input buffer overrun**
Software or hardware input buffer on serial port overflows with data caused by improper or nonexistent pacing.

SCPI Error Messages

Query Errors [–499, –400]

An < error/event number > in the range [–499, –400] indicates that the output queue control of the instrument has detected a problem with the message exchange protocol described in *IEEE 488.2*, chapter 6. The occurrence of any error in this class should cause the query error bit (bit 2) in the event status register (*IEEE 488.2*, section 11.5.1) to be set. These errors correspond to message exchange protocol errors described in *IEEE 488.2*, section 6.5. One of the following is true:

- An attempt is being made to read data from the output queue when no output is either present or pending;
- Data in the output queue has been lost.

Events that generate query errors shall not generate command errors, execution errors, or device-specific errors; see the other error definitions in this section.

–400

Query error

This is the general query error for devices that cannot detect more specific errors. This code indicates only that a Query Error as defined in *IEEE 488.2*, 11.5.1.1.7 and 6.3 has occurred.

–410

Query INTERRUPTED

Indicates that a condition causing an INTERRUPTED Query error occurred (see *IEEE 488.2*, 6.3.2.3); for example, a query followed by DAB or GET before a response was completely sent.

–420

Query UNTERMINATED

Indicates that a condition causing an UNTERMINATED Query error occurred (see *IEEE 488.2*, 6.3.2.2); for example, the device was addressed to talk and an incomplete program message was received.

–430

Query DEADLOCKED

Indicates that a condition causing a DEADLOCKED Query error occurred (see *IEEE 488.2*, 6.3.1.7); for example, both input buffer and output buffer are full and the device cannot continue.

SCPI Error Messages

-440

Query UNTERMINATED after indefinite response

Indicates that a query was received in the same program message after a query requesting an indefinite response was executed (see *IEEE 488.2*, 6.5.7.5.7.)

General Index

A

Alarms

- ATM, 6-18
- SDH, 4-41
- SONET, 5-37

Application Program Examples, 10-1

Autosetup, 2-18

B

BOOTP, 1-11

C

Command Errors, 12-2

Command Reference, 4-3, 5-3

Command Syntax, 2-3

Connecting the LAN to the Instrument Remote Control Interface, 1-12

Connecting to a LAN, 1-10

Connecting to HP-IB, 1-3

Connecting to RS-232-C, 1-4

Connection via a Modem, 1-6

Controlling the Instrument via RS-232-C, 1-8

D

DCC port, 4-60, 4-79, 5-55

Default Gateway IP Address, 1-10

Device Clear (CLEAR), 9-3

DNA Option USS, 1-2

E

Errors

- SDH, 4-36

- SONET, 5-32

Example Program, 8-33

Execution Errors, 12-8

F

FETCh subsystem, 3-103, 4-99, 5-93, 6-36, 7-26

G

General Information, 9-2

Graphics

- Configuring, 2-27

- Managing Stores, 2-29

- Obtaining End of Measurement Results, 2-35

- Retrieving Data for a Single Graph, 2-33

General Index

Retrieving Store Data, 2-31

H

HP-IB Communication with the System Controller, 1-3

HP-IB Operating Distances, 1-3

HP-IB Options A3B & A3D (1A8), 1-2

HP-IB Universal Commands, 9-3

I

IEEE common capabilities, 2-62

Initialization, 1-14

Initializing the HP 37718A, 10-2

INPut subsystem, 2-14, 3-51, 4-63, 5-59, 6-20, 7-18

INSTrument subsystem, 2-8

Internet address, 1-10

Interpreting Interrupts, 8-33

L

LAN

BOOTP, 1-11

Current Settings, 1-11

New Settings, 1-12

LAN Option A3B (1F7), 1-2

Linking Command Statements, 2-4

Local (LOCAL), 9-4

Local Lockout (LOCAL LOCKOUT), 9-4

M

Methods of Remote Control, 1-2

Modem to Instrument (Options A3B & A3D), 1-5

MSP messages, 4-54, 5-49

O

Optical Power Measurement Settings, 4-87, 5-81

OUTPut subsystem, 3-4, 4-4, 5-4, 6-4, 7-4

Overhead BER test, SDH, 4-81

P

Pointer Graph, SDH, 4-80

Pointer moves, SDH, 4-42

Pointer moves, SONET, 5-38

Program examples, 10-3

Programming Interrupts, 8-32

General Index

Q

Query Errors, 12-15

R

Receiver

- ATM Settings, 6-22
- Common Commands, 2-17
- Jitter Settings, 7-21
- SDH AU Layer Selection, 4-68
- SDH Mapping settings, 4-67
- SDH overhead capture, 4-76
- SDH Settings, 4-67
- SDH Test Function Commands, 4-76
- SDH TUG Channel, 4-70
- SONET Settings, 5-63
- SONET SPE Layer Selection, 5-64
- SONET Test Function Commands, 5-71
- SONET VT Group, 5-66
- SPDH Test Function Commands, 3-74
- Structured PDH Settings, 3-62
- Unstructured PDH Settings, 3-57

Remote Control Commands, 2-6

Remote Control, Methods of, 1-2

Remote Enable (REMOTE), 9-3

Results

- ATM Alarm Seconds, 6-35
- ATM CRC4 Analysis, 6-34
- ATM Cumulative, 6-31
- ATM EM BIP Analysis, 6-33
- ATM FEBE/REI Analysis, 6-33
- ATM Mean Cell Transfer Delay, 6-35
- ATM REBE Analysis, 6-34
- ATM Short Term, 6-30
- common, 2-22, 3-82
- Frequency, 3-86, 4-88
- Frequency (Sonet), 5-82
- Jitter/Wander, 7-24
- SDH Alarm Seconds, 4-98
- SDH Cumulative, 4-89
- SDH MS B2 BIP Analysis, 4-90
- SDH Optical Power, 4-97
- SDH Path B3 BIP Analysis, 4-92
- SDH Path FEBE Analysis, 4-92
- SDH Path IEC Analysis, 4-93
- SDH Path MS FEBE Analysis, 4-91
- SDH Pointer Activity, 4-97
- SDH RS B1 BIP Analysis, 4-90

General Index

SDH Service Disruption, 4-96
SDH Short Term, 4-88
SDH Tributary Path BIP Analysis, 4-93
SDH Tributary Path FEBE Analysis, 4-94
SONET Alarm Seconds, 5-91
SONET Block Based Bit Analysis, 5-88
SONET Cumulative, 5-83
SONET CV-IEC Analysis, 5-86
SONET CV-L Analysis, 5-84
SONET CV-S Analysis, 5-84
SONET Line RE-L Analysis, 5-85
SONET Optical Power, 5-90
SONET Path CV-P Analysis, 5-85
SONET Pointer Activity, 5-90
SONET REI-P Analysis, 5-86
SONET Service Disruption, 5-90
SONET Short Term, 5-82
SONET Tributary Path CV-V Analysis, 5-87
SONET Tributary Path REI-V Analysis, 5-87
Structured PDH 140 Mb/S FAS Error Analysis, 3-100
Structured PDH 140 Mb/s G.826 Analysis, 3-89
Structured PDH 2 Mb/S FAS Error Analysis, 3-98
Structured PDH 2 Mb/s G.826 Analysis, 3-92, 3-93, 3-94, 3-95
Structured PDH 34 Mb/S FAS Error Analysis, 3-99
Structured PDH 34 Mb/s G.826 Analysis, 3-90
Structured PDH 8 Mb/S FAS Error Analysis, 3-99
Structured PDH 8 Mb/s G.826 Analysis, 3-91
Structured PDH Alarm Seconds, 3-102
Structured PDH and Payload G.821 Analysis, 3-89
Structured PDH CRC Error Analysis, 3-100
Structured PDH Cumulative, 3-88
Structured PDH M.2100 Analysis, 3-95
Structured PDH M.2110 Analysis, 3-97
Structured PDH M.2120 ANALYSIS, 3-98
Structured PDH REBE Error Analysis, 3-101
Structured PDH Round Trip Delay, 3-102
Structured PDH Short Term, 3-86
Unstructured PDH Alarm Seconds, 3-85
Unstructured PDH and Payload G.821 Analysis, 3-83
Unstructured PDH CRC Error Analysis, 3-84
Unstructured PDH Cumulative, 3-82
Unstructured PDH FAS Error Analysis, 3-84
Unstructured PDH M.2100 Analysis, 3-83
Unstructured PDH REBE Error Analysis, 3-85
Unstructured PDH Short Term, 3-82
Unstructured PDH Spare Bits, 3-85
RS-232-C Communication with the Terminal/Computer, 1-6

General Index

RS-232-C Computer Mode, 1-6
RS-232-C Computer to Instrument (Option A3B & A3D), 1-6
RS-232-C Connection via a Modem, 1-5
RS-232-C Options A3B, A3D (1CW), 1-2
RS-232-C Terminal Mode, 1-4
RS-232-C Terminal to Instrument (Options A3B & A3D), 1-5

S

SCPI Command Format, 2-3
SCPI Error Messages, 12-2
SCPI Long Form Command Headers, 2-4
SCPI Overview, 9-2
SENSe subsystem, 2-15
Sequences, SDH overhead, 4-49
Sequences, SONET overhead, 5-45
Serial Poll (SPOLL), 9-3
Signaling bits
 2M CAS, 3-26
 DS1, 3-34
SONET Mapping Settings, 5-63
SOURce subsystem, 2-9
SOURce subsystem - Transmitter SDH OVERHEAD SETUP, 4-23
SOURce subsystem - Transmitter SONET OVERHEAD SETUP, 5-21
Status Byte, 8-5
Status Register
 ATM, 8-27
 BINary, 8-13
 DATA, 8-10
 DISK, 8-28
 FAS, 8-12
 INSTrument, 8-9
 JITTer, 8-18
 M140, 8-20
 M2, 8-23
 M34, 8-21
 M8, 8-22
 OPERation, 8-8
 QUEStionable, 2-45, 8-7
 SDH, 8-14, 8-16
 SDH2, 8-15, 8-17
 SPDH, 8-19
 Standard Event, 8-6
 Unstructured PDH, 8-11
Status Registers Relationship, 8-29
Status Reporting, 8-2

General Index

STATus subsystem, 2-44
Subnet Mask, 1-10
SYSTem Subsystem, 2-47

T

Test Timing, 2-20
Transmitter
 ATM, 6-6
 Common Commands, 2-11
 Jitter, 7-6
 PDH Binary, 3-14
 SDH AU Layer Selection, 4-11
 SDH Clock settings, 4-7
 SDH overhead, 4-61
 SDH Payload Layer Selection, 4-13
 SDH Settings, 3-49, 4-7
 SDH Test Function, 4-36
 SDH Thru mode settings, 4-9
 SDH TU Payload and Test Pattern, 4-15
 SDH TUG Channel, 4-14
 SONET Clock settings, 5-7
 SONET overhead, 5-56
 SONET Payload Layer Selection, 5-13
 SONET Settings, 5-7
 SONET SPE Layer Selection, 5-11
 SONET Test Function, 5-32
 SONET Thru mode settings, 5-9
 SONET VT Group, 5-13
 SONET VT Payload and Test Pattern, 5-14
 Structured PDH, 3-17
 Structured PDH Binary, 3-26
 Unstructured PDH, 3-9
 Wander, 7-15
Trouble Scan, 2-23

V

VT Layer Selection, 5-64

Command Index

:SENSe:DATA:TELEcom:SPDH:BINary:POLarity:CLOCK <discrete> 3-65
5-20
*CLS 2-62
*ESE <numeric> 2-62
*ESE? 2-62
*ESR? 2-62
*IDN? 2-62
*LRN? 2-62
*OPC 2-63
*OPT? 2-63
*PSC <numeric> 2-64
*RCL <numeric> 2-64
*RST 2-65
*SAV <numeric> 2-65
*SRE <numeric> 2-65
*STB? 2-65
*TRG 2-65
*WAI 2-65
:SENSe:DATA:TELEcom:SONet:TFUNction:TYPE <discrete> 5-71
:FETCh:ARRay:DATA:TELEcom:JITTer:ATOLerance? 7-26
:FETCh:ARRay:DATA:TELEcom:JITTer:TRANsfer? 7-26
:FETCh:ARRay:DATA:TELEcom:SDH:ASCan? 4-103
:FETCh:ARRay:DATA:TELEcom:SDH:OCAPture? <numeric> 4-114
:FETCh:ARRay:DATA:TELEcom:SDH:OVERhead? <numeric><numeric> <numeric> 4-115
:FETCh:ARRay:DATA:TELEcom:SDH:PGRaph? 4-113
:FETCh:ARRay:DATA:TELEcom:SDH:POVerhead? <numeric> 4-115
:FETCh:ARRay:DATA:TELEcom:SDH:TSCan? 4-109
:FETCh:ARRay:DATA:TELEcom:SONet:ASCan? 5-96
:FETCh:ARRay:DATA:TELEcom:SONet:OCAPture? <numeric> 5-103
:FETCh:ARRay:DATA:TELEcom:SONet:OVERhead? <numeric><numeric> <numeric> 5-104
:FETCh:ARRay:DATA:TELEcom:SONet:PGRaph? 5-102
:FETCh:ARRay:DATA:TELEcom:SONet:POVerhead? <numeric> 5-104
:FETCh:ARRay:DATA:TELEcom:SONet:TSCan? 5-100
:FETCh:ARRay:DATA:TELEcom:SPDH:ASCan:M140? 3-105
:FETCh:ARRay:DATA:TELEcom:SPDH:ASCan:M2? 3-105
:FETCh:ARRay:DATA:TELEcom:SPDH:ASCan:M34? 3-105
:FETCh:ARRay:DATA:TELEcom:SPDH:ASCan:M8? 3-105
:FETCh:ARRay:DATA:TELEcom:SPDH:ASCan? 3-105
:FETCh:SCALar:DATA:TELEcom:PDH:CAS? 3-103

Command Index

:FETCh:SCALAr:DATA:TELEcom:PDH:NFASt? 3-103
:FETCh:SCALAr:DATA:TELEcom:PDH:SPARe? 3-103
:FETCh:SCALAr:DATA:TELEcom:SDH:OVERhead? <numeric>,<numeric>, <discrete> 4-101
:FETCh:SCALAr:DATA:TELEcom:SDH:POVerhead:H4Sequence? 4-102
:FETCh:SCALAr:DATA:TELEcom:SDH:POVerhead? <discrete> 4-102
:FETCh:SCALAr:DATA:TELEcom:SDH:TRIButary:POVerhead:SLABel? 4-103
:FETCh:SCALAr:DATA:TELEcom:SDH:TRIButary:POVerhead? <discrete> 4-102
:FETCh:SCALAr:DATA:TELEcom:SONet:OVERhead? <numeric>,<numeric>, <discrete> 5-95
:FETCh:SCALAr:DATA:TELEcom:SONet:POVerhead:H4Sequence? 5-95
:FETCh:SCALAr:DATA:TELEcom:SONet:POVerhead? <discrete> 5-96
:FETCh:SCALAr:DATA:TELEcom:SONet:TRIButary:POVerhead:SLABel? 5-96
:FETCh:SCALAr:DATA:TELEcom:SONet:TRIButary:POVerhead? <discrete> 5-96
:FETCh:SCALAr:DATA:TELEcom:SPDH:TSLot:SIGNaling? <numeric> 3-104
:FETCh:STRing:DATA:TELEcom:ATM:TTRace:HEXadecimal? 6-36
:FETCh:STRing:DATA:TELEcom:ATM:TTRace? 6-36
:FETCh:STRing:DATA:TELEcom:SDH:J0:HEXadecimal? 4-99
:FETCh:STRing:DATA:TELEcom:SDH:J0? 4-99
:FETCh:STRing:DATA:TELEcom:SDH:J1:HEXadecimal? 4-99
:FETCh:STRing:DATA:TELEcom:SDH:J1? 4-99
:FETCh:STRing:DATA:TELEcom:SDH:K1? 4-101
:FETCh:STRing:DATA:TELEcom:SDH:K2? 4-101
:FETCh:STRing:DATA:TELEcom:SDH:S1? 4-101
:FETCh:STRing:DATA:TELEcom:SDH:TRIButary:J1:HEXadecimal? 4-100
:FETCh:STRing:DATA:TELEcom:SDH:TRIButary:J1? 4-100
:FETCh:STRing:DATA:TELEcom:SDH:TRIButary:J2:HEXadecimal? 4-100
:FETCh:STRing:DATA:TELEcom:SDH:TRIButary:J2? 4-100
:FETCh:STRing:DATA:TELEcom:SONet:J0:HEXadecimal? 5-93
:FETCh:STRing:DATA:TELEcom:SONet:J0? 5-93
:FETCh:STRing:DATA:TELEcom:SONet:J1:HEXadecimal? 5-93
:FETCh:STRing:DATA:TELEcom:SONet:J1? 5-93
:FETCh:STRing:DATA:TELEcom:SONet:K1? 5-94
:FETCh:STRing:DATA:TELEcom:SONet:K2? 5-94
:FETCh:STRing:DATA:TELEcom:SONet:S1? 5-94
:FETCh:STRing:DATA:TELEcom:SONet:TRIButary:J2:HEXadecimal? 5-94
:FETCh:STRing:DATA:TELEcom:SONet:TRIButary:J2? 5-94
:FETCh:STRing:DATA:TELEcom:SPDH:FEAC:LAST:TEXT? 3-104
:FETCh:STRing:DATA:TELEcom:SPDH:FEAC:LAST? 3-104
:FETCh:STRing:DATA:TELEcom:SPDH:FEAC:TEXT? 3-103
:FETCh:STRing:DATA:TELEcom:SPDH:FEAC? 3-103

Command Index

:INPut:TELEcom:ATM:BALance <discrete> 6-21
:INPut:TELEcom:ATM:CODE <discrete> 6-20
:INPut:TELEcom:ATM:RATE <discrete> 6-20
:INPut:TELEcom:JITTer:EQUal <boolean> 7-18
:INPut:TELEcom:JITTer:GAIN <discrete> 7-18
:INPut:TELEcom:JITTer:RATE <discrete> 7-18
:INPut:TELEcom:JITTer:WANDer <boolean> 7-19
:INPut:TELEcom:JITTer:WANDer:BALance <discrete> 7-19
:INPut:TELEcom:JITTer:WANDer:FORMat <discrete> 7-19
:INPut:TELEcom:LEVel <discrete> 2-14
:INPut:TELEcom:OC12:INTerface <discrete> 5-61
:INPut:TELEcom:OC12:INTerface:BINary:CLOCK:POLarity <discrete> 5-60
:INPut:TELEcom:OC12:INTerface:BINary:DATA:POLarity <discrete> 5-61
:INPut:TELEcom:OC12:RATE <discrete> 5-60
:INPut:TELEcom:OPT4:INTerface <discrete> 4-65
:INPut:TELEcom:OPT4:INTerface:BINary:CLOCK:POLarity <discrete> 4-64
:INPut:TELEcom:OPT4:INTerface:BINary:DATA:POLarity <discrete> 4-65
:INPut:TELEcom:OPT4:RATE <discrete> 4-64
:INPut:TELEcom:PDH:BALance <discrete> 3-51
:INPut:TELEcom:PDH:BINary:INTerface <discrete> 3-52
:INPut:TELEcom:PDH:CODE <discrete> 3-51
:INPut:TELEcom:PDH:RATE <discrete> 3-51
:INPut:TELEcom:SDH:GAIN <discrete> 4-63
:INPut:TELEcom:SDH:LEVel <discrete> 4-63
:INPut:TELEcom:SDH:RATE <discrete> 4-63
:INPut:TELEcom:SONet:GAIN <discrete> 5-59
:INPut:TELEcom:SONet:LEVel <discrete> 5-59
:INPut:TELEcom:SONet:RATE <discrete> 5-59
:INPut:TELEcom:SPDH:BALance <discrete> 3-54
:INPut:TELEcom:SPDH:CODE <discrete> 3-53
:INPut:TELEcom:SPDH:EQUalisation <boolean> 3-54
:INPut:TELEcom:SPDH:GAIN <discrete> 3-54
:INPut:TELEcom:SPDH:INSert:CODE <discrete> 3-53
:INPut:TELEcom:SPDH:RATE <discrete> 3-52
:INSTrument:COUPle <mode> 2-8
:OUTPut:DATA:TELEcom:ATM:RATE <discrete> 6-4
:OUTPut:TELEcom:ATM:BALance <discrete> 6-5
:OUTPut:TELEcom:ATM:CODE <discrete> 6-4
:OUTPut:TELEcom:JITTer <discrete> 7-4

Command Index

:OUTPut:TELEcom:JITTer:AUTotol <boolean> 7-4
:OUTPut:TELEcom:JITTer:TRANsfer <boolean> 7-5
:OUTPut:TELEcom:JITTer:TRANsfer:CALibrate? 7-5
:OUTPut:TELEcom:JITTer:WANDer <boolean> 7-5
:OUTPut:TELEcom:OC12:INTerface <discrete> 5-5
:OUTPut:TELEcom:OC12:INTerface:BINary:CLOCK:POLarity <discrete> 5-5
:OUTPut:TELEcom:OC12:INTerface:BINary:DATA:POLarity <discrete> 5-6
:OUTPut:TELEcom:OC12:RATE <discrete> 5-4
:OUTPut:TELEcom:OC12:WAVelength <discrete> 5-6
:OUTPut:TELEcom:OC3:RATE? 5-4
:OUTPut:TELEcom:OPT1:RATE? 4-4
:OUTPut:TELEcom:OPT4:INTerface <discrete> 4-5
:OUTPut:TELEcom:OPT4:INTerface:BINary:CLOCK:POLarity <discrete> 4-5
:OUTPut:TELEcom:OPT4:INTerface:BINary:DATA:POLarity <discrete> 4-6
:OUTPut:TELEcom:OPT4:RATE <discrete> 4-4
:OUTPut:TELEcom:OPT4:WAVelength <discrete> 4-6
:OUTPut:TELEcom:PDH:BALance <discrete> 3-4
:OUTPut:TELEcom:PDH:BINary:INTerface <discrete> 3-5
:OUTPut:TELEcom:PDH:CODE <discrete> 3-4
:OUTPut:TELEcom:PDH:RATE <discrete> 3-4
:OUTPut:TELEcom:SDH:LEVel <discrete> 4-4
:OUTPut:TELEcom:SDH:RATE <discrete> 4-4
:OUTPut:TELEcom:SONet:LEVel <discrete> 5-4
:OUTPut:TELEcom:SONet:RATE <discrete> 5-4
:OUTPut:TELEcom:SPDH:BALance <discrete> 3-7
:OUTPut:TELEcom:SPDH:CODE <discrete> 3-6
:OUTPut:TELEcom:SPDH:DROP:CODE <discrete> 3-6
:OUTPut:TELEcom:SPDH:LEVel <discrete> 3-7
:OUTPut:TELEcom:SPDH:RATE <discrete> 3-5
:OUTPut:TELEcom:SPDH:STATe <boolean> 3-7
:SENSe:DATA:TELEcom:ATM:CDV:PCRate <discrete> 6-27
:SENSe:DATA:TELEcom:ATM:CDV:TOLerance <discrete> 6-28
:SENSe:DATA:TELEcom:ATM:CDV:UPCR <numeric> 6-27
:SENSe:DATA:TELEcom:ATM:CDV:UTOL <numeric> 6-28
:SENSe:DATA:TELEcom:ATM:HEADer:CLP <discrete> 6-25
:SENSe:DATA:TELEcom:ATM:HEADer:GFC <discrete> 6-23
:SENSe:DATA:TELEcom:ATM:HEADer:PTI <string> 6-25
:SENSe:DATA:TELEcom:ATM:HEADer:SGFC <numeric> 6-23
:SENSe:DATA:TELEcom:ATM:HEADer:SVCI <numeric> 6-25

Command Index

:SENSe:DATA:TELEcom:ATM:HEADer:SVPI <numeric> 6-24
:SENSe:DATA:TELEcom:ATM:HEADer:VCI <discrete> 6-24
:SENSe:DATA:TELEcom:ATM:HEADer:VPI <discrete> 6-24
:SENSe:DATA:TELEcom:ATM:M2:CRC4 <boolean> 6-22
:SENSe:DATA:TELEcom:ATM:NINTerface <discrete> 6-23
:SENSe:DATA:TELEcom:ATM:PAYLoad <discrete> 6-26
:SENSe:DATA:TELEcom:ATM:PAYLoad:PATtern <discrete> 6-26
:SENSe:DATA:TELEcom:ATM:PAYLoad:UWORD <string> 6-27
:SENSe:DATA:TELEcom:ATM:POAM <discrete> 6-28
:SENSe:DATA:TELEcom:ATM:POAM:BLOCK <discrete> 6-29
:SENSe:DATA:TELEcom:ATM:SElect <discrete> 6-22
:SENSe:DATA:TELEcom:AUTOsetup 2-18
:SENSe:DATA:TELEcom:JITTer:FILTer <discrete> 7-21
:SENSe:DATA:TELEcom:JITTer:FILTer:RMS <discrete> 7-22
:SENSe:DATA:TELEcom:JITTer:RANGe <discrete> 7-22
:SENSe:DATA:TELEcom:JITTer:SETTings <discrete> 7-21
:SENSe:DATA:TELEcom:JITTer:THReshold <numeric> 7-22
:SENSe:DATA:TELEcom:PDH:ATYPe <discrete> 3-61
:SENSe:DATA:TELEcom:PDH:BINary:FREQ <discrete> 3-58
:SENSe:DATA:TELEcom:PDH:BINary:POLarity:CLOCK <discrete> 3-59
:SENSe:DATA:TELEcom:PDH:BINary:POLarity:DATA <discrete> 3-60
:SENSe:DATA:TELEcom:PDH:BINary:POLarity:EXTClock <discrete> 3-60
:SENSe:DATA:TELEcom:PDH:BINary:THReshold:CLOCK <discrete> 3-58
:SENSe:DATA:TELEcom:PDH:BINary:THReshold:DATA <discrete> 3-60
:SENSe:DATA:TELEcom:PDH:BINary:THReshold:EXTClock <discrete> 3-59
:SENSe:DATA:TELEcom:PDH:FRAMing <discrete> 3-58
:SENSe:DATA:TELEcom:PDH:PAYLoad:PATtern <discrete> 3-57
:SENSe:DATA:TELEcom:PDH:PAYLoad:UWORD <string> 3-57
:SENSe:DATA:TELEcom:SDH:ASCan <boolean> 4-83
:SENSe:DATA:TELEcom:SDH:ASCan:BIP <discrete> 4-83
:SENSe:DATA:TELEcom:SDH:ASCan:MODE <discrete> 4-83
:SENSe:DATA:TELEcom:SDH:AU:TYPE <discrete> 4-68
:SENSe:DATA:TELEcom:SDH:AU3 <numeric> 4-68
:SENSe:DATA:TELEcom:SDH:DDCC <discrete> 4-79
:SENSe:DATA:TELEcom:SDH:DDCC:POLarity <discrete> 4-80
:SENSe:DATA:TELEcom:SDH:MAPPing <discrete> 4-69
:SENSe:DATA:TELEcom:SDH:OBERtest:CHANnel <discrete> 4-81
:SENSe:DATA:TELEcom:SDH:OBERtest:CHANnel:SElect <numeric> 4-82
:SENSe:DATA:TELEcom:SDH:OBERtest:COLumn <numeric> 4-81

Command Index

:SENSe:DATA:TELEcom:SDH:OCAPture <discrete> 4-76
:SENSe:DATA:TELEcom:SDH:OCAPture:CHANnel <discrete> 4-77
:SENSe:DATA:TELEcom:SDH:OCAPture:CHANnel:SElect <numeric> 4-78
:SENSe:DATA:TELEcom:SDH:OCAPture:COLumn <numeric> 4-78
:SENSe:DATA:TELEcom:SDH:OCAPture:OHBYte <discrete> 4-77
:SENSe:DATA:TELEcom:SDH:OCAPture:TRIGger <discrete> 4-78
:SENSe:DATA:TELEcom:SDH:OCAPture:TRIGger:PATTern <string> 4-79
:SENSe:DATA:TELEcom:SDH:PAYLoad <discrete> 4-68
:SENSe:DATA:TELEcom:SDH:PAYLoad:PATTern <discrete> 4-72
:SENSe:DATA:TELEcom:SDH:PAYLoad:STRucture <discrete> 4-72
:SENSe:DATA:TELEcom:SDH:PAYLoad:TYPE <discrete> 4-71
:SENSe:DATA:TELEcom:SDH:PAYLoad:UWORd <string> 4-73
:SENSe:DATA:TELEcom:SDH:PGRaph:CINTerval <discrete> 4-81
:SENSe:DATA:TELEcom:SDH:PGRaph:PTYPE <discrete> 4-80
:SENSe:DATA:TELEcom:SDH:PRBS:POLarity <discrete> 4-74
:SENSe:DATA:TELEcom:SDH:PRIMary:TS0 <boolean> 4-70
:SENSe:DATA:TELEcom:SDH:TFUNction:TYPE <discrete> 4-76
:SENSe:DATA:TELEcom:SDH:TRIButary <numeric> 4-71
:SENSe:DATA:TELEcom:SDH:TRIButary:CONCatenate <numeric>,<numeric> 4-74
:SENSe:DATA:TELEcom:SDH:TRIButary:MAPPing <discrete> 4-69
:SENSe:DATA:TELEcom:SDH:TSCan <boolean> 4-85
:SENSe:DATA:TELEcom:SDH:TSCan:BIP <discrete> 4-85
:SENSe:DATA:TELEcom:SDH:TSCan:PERiod <numeric>,<suffix> 4-85
:SENSe:DATA:TELEcom:SDH:TUG2 <numeric> 4-70
:SENSe:DATA:TELEcom:SDH:TUG3 <numeric> 4-70
:SENSe:DATA:TELEcom:SDH:VC4 <numeric> 4-67
:SENSe:DATA:TELEcom:SDH:WAVelength <discrete> 4-87
:SENSe:DATA:TELEcom:SENSe <discrete> 2-17
:SENSe:DATA:TELEcom:SMG <discrete> 2-27
:SENSe:DATA:TELEcom:SMG:ALABels? <numeric>,<numeric> 2-32
:SENSe:DATA:TELEcom:SMG:CATalog? 2-29
:SENSe:DATA:TELEcom:SMG:DATA? <numeric>,<string> 2-35
:SENSe:DATA:TELEcom:SMG:DELeTe <numeric> 2-29
:SENSe:DATA:TELEcom:SMG:DELeTe:ALL 2-30
:SENSe:DATA:TELEcom:SMG:EDATa? <numeric>,<numeric> 2-33
:SENSe:DATA:TELEcom:SMG:HDATa:NORMal? <numeric> 2-31
:SENSe:DATA:TELEcom:SMG:HDATa:PACKed? <numeric> 2-32
:SENSe:DATA:TELEcom:SMG:LABels? <numeric> 2-31
:SENSe:DATA:TELEcom:SMG:RESolution <discrete> 2-27

Command Index

:SENSe:DATA:TELEcom:SMG:SINformation? <numeric> 2-30
:SENSe:DATA:TELEcom:SMG:SIZE? 2-29
:SENSe:DATA:TELEcom:SMG:STORe <discrete> 2-27
:SENSe:DATA:TELEcom:SMG:TINformation? <numeric>,<numeric> 2-34
:SENSe:DATA:TELEcom:SMG:VDATa? <numeric>,<numeric> 2-33
:SENSe:DATA:TELEcom:SONet:ASCan <boolean> 5-77
:SENSe:DATA:TELEcom:SONet:ASCan:BIP <discrete> 5-77
:SENSe:DATA:TELEcom:SONet:ASCan:MODE <discrete> 5-77
:SENSe:DATA:TELEcom:SONet:DDCC <discrete> 5-74
:SENSe:DATA:TELEcom:SONet:DDCC:POLarity <discrete> 5-74
:SENSe:DATA:TELEcom:SONet:MAPPing <discrete> 5-65
:SENSe:DATA:TELEcom:SONet:OBERtest:STS1 <numeric> 5-76
:SENSe:DATA:TELEcom:SONet:OBERtest:STS3 <discrete> 5-75
:SENSe:DATA:TELEcom:SONet:OBERtest:STS3:SElect <numeric> 5-76
:SENSe:DATA:TELEcom:SONet:OCAPture <discrete> 5-71
:SENSe:DATA:TELEcom:SONet:OCAPture:OHBYte <discrete> 5-71
:SENSe:DATA:TELEcom:SONet:OCAPture:STS1 <numeric> 5-72
:SENSe:DATA:TELEcom:SONet:OCAPture:STS3:SElect <numeric> 5-72
:SENSe:DATA:TELEcom:SONet:OCAPture:TRIGger <discrete> 5-73
:SENSe:DATA:TELEcom:SONet:OCAPture:TRIGger:PATTern <string> 5-73
:SENSe:DATA:TELEcom:SONet:PAYLoad <discrete> 5-64
:SENSe:DATA:TELEcom:SONet:PAYLoad:PATTern <discrete> 5-68
:SENSe:DATA:TELEcom:SONet:PAYLoad:STRucture <discrete> 5-67
:SENSe:DATA:TELEcom:SONet:PAYLoad:TYPE <discrete> 5-67
:SENSe:DATA:TELEcom:SONet:PAYLoad:UWORD <string> 5-69
:SENSe:DATA:TELEcom:SONet:PGRaph:CINterval <discrete> 5-75
:SENSe:DATA:TELEcom:SONet:PGRaph:PTYPE <discrete> 5-74
:SENSe:DATA:TELEcom:SONet:PRBS:POLarity <discrete> 5-69
:SENSe:DATA:TELEcom:SONet:PRIMary:TS0 <boolean> 5-66
:SENSe:DATA:TELEcom:SONet:SPE:TYPE <discrete> 5-64
:SENSe:DATA:TELEcom:SONet:STS1 <numeric> 5-64
:SENSe:DATA:TELEcom:SONet:STS3 <numeric> 5-63
:SENSe:DATA:TELEcom:SONet:TRIButary <numeric> 5-66
:SENSe:DATA:TELEcom:SONet:TRIButary:CONCatenate <numeric>,<numeric> 5-69
:SENSe:DATA:TELEcom:SONet:TRIButary:MAPPing <discrete> 5-65
:SENSe:DATA:TELEcom:SONet:TSCan <boolean> 5-79
:SENSe:DATA:TELEcom:SONet:TSCan:BIP <discrete> 5-79
:SENSe:DATA:TELEcom:SONet:TSCan:PERiod <numeric>,<suffix> 5-79
:SENSe:DATA:TELEcom:SONet:VTGRoup <numeric> 5-66

Command Index

:SENSe:DATA:TELEcom:SONet:WAVelength <discrete> 5-81
:SENSe:DATA:TELEcom:SPDH:ANALySis:M2110 :PALLocation <numeric> 3-76
:SENSe:DATA:TELEcom:SPDH:ANALySis:M2110 <discrete> 3-75
:SENSe:DATA:TELEcom:SPDH:ANALySis:M2110:PATH <discrete> 3-75
:SENSe:DATA:TELEcom:SPDH:ANALySis:M2110:PATH? 3-76
:SENSe:DATA:TELEcom:SPDH:ANALySis:M2110:USER: SESecond <discrete>, <numeric> 3-77
:SENSe:DATA:TELEcom:SPDH:ANALySis:M2110:USER:ESECond <discrete>, <numeric> 3-76
:SENSe:DATA:TELEcom:SPDH:ANALySis:M2120 <discrete> 3-78
:SENSe:DATA:TELEcom:SPDH:ANALySis:M2120:MFAcTtor <numeric> 3-78
:SENSe:DATA:TELEcom:SPDH:ANALySis:M2120:USER: ESECond <discrete>, <numeric> 3-78
:SENSe:DATA:TELEcom:SPDH:ANALySis:M2120:USER: SESecond <discrete>, <numeric> 3-79
:SENSe:DATA:TELEcom:SPDH:ASCan <boolean> 3-80
:SENSe:DATA:TELEcom:SPDH:BINary:FREQ <discrete> 3-64
:SENSe:DATA:TELEcom:SPDH:BINary:POLarity:DATA <discrete> 3-67
:SENSe:DATA:TELEcom:SPDH:BINary:POLarity:EXTClock <discrete> 3-66
:SENSe:DATA:TELEcom:SPDH:BINary:THReshold:CLOCK <discrete> 3-65
:SENSe:DATA:TELEcom:SPDH:BINary:THReshold:DATA <discrete> 3-66
:SENSe:DATA:TELEcom:SPDH:BINary:THReshold:EXTClock <discrete> 3-65
:SENSe:DATA:TELEcom:SPDH:PATtern <discrete> 3-62
:SENSe:DATA:TELEcom:SPDH:PAYLoad:STRucture <discrete> 3-64
:SENSe:DATA:TELEcom:SPDH:PAYLoad:TYPE <discrete> 3-63
:SENSe:DATA:TELEcom:SPDH:PRBS:POLarity <discrete> 3-63
:SENSe:DATA:TELEcom:SPDH:RTDelay <boolean> 3-81
:SENSe:DATA:TELEcom:SPDH:TSIGnal:PAYLoad <discrete> 3-68
:SENSe:DATA:TELEcom:SPDH:TSIGnal:RATE <discrete> 3-68
:SENSe:DATA:TELEcom:SPDH:TSIGnal:TRIButary:DS1 <discrete> 3-70
:SENSe:DATA:TELEcom:SPDH:TSIGnal:TRIButary:DS2 <discrete> 3-71
:SENSe:DATA:TELEcom:SPDH:TSIGnal:TRIButary:M2 <discrete> 3-70
:SENSe:DATA:TELEcom:SPDH:TSIGnal:TRIButary:M34 <discrete> 3-69
:SENSe:DATA:TELEcom:SPDH:TSIGnal:TRIButary:M8 <discrete> 3-69
:SENSe:DATA:TELEcom:SPDH:TSIGnal:TSLot:DS1:K56 <numeric> 3-72
:SENSe:DATA:TELEcom:SPDH:TSIGnal:TSLot:DS1:K56XN <string> 3-73
:SENSe:DATA:TELEcom:SPDH:TSIGnal:TSLot:DS1:K64 <numeric> 3-73
:SENSe:DATA:TELEcom:SPDH:TSIGnal:TSLot:DS1:K64XN <string> 3-73
:SENSe:DATA:TELEcom:SPDH:TSIGnal:TSLot:M2:K64 <numeric> 3-72
:SENSe:DATA:TELEcom:SPDH:TSIGnal:TSLot:M2:K64XN <string> 3-72
:SENSe:DATA:TELEcom:SPDH:UWORd <string> 3-63
:SENSe:DATA:TELEcom:STERm:PERiod <numeric>,<suffix> 2-21
:SENSe:DATA:TELEcom:TEST <boolean> 2-18

Command Index

:SENSe:DATA:TELEcom:TEST:PERiod <numeric> <suffix> 2-20
:SENSe:DATA:TELEcom:TEST:STARt <numeric>,<numeric>,<numeric>, <numeric>, <numeric> 2-21
:SENSe:DATA:TELEcom:TEST:SUSPend <boolean> 2-22
:SENSe:DATA:TELEcom:TEST:TYPE <discrete> 2-20
:SENSe:DATA:TELEcom:TFUNction <discrete> 2-18
:SENSe:DATA:TELEcom:TFUNction:SDISruption <discrete> 3-74
:SENSe:DATA:TELEcom:TSCan:ERRors? 2-23
:SENSe:DATA:TELEcom:TSCan:TYPE? 2-23
:SENSe:DATA? <"result"> 3-82
:SOURce:CLOCK:JITTer:BALance <discrete> 7-16
:SOURce:CLOCK:JITTer:FORMat <discrete> 7-16
:SOURce:CLOCK:PDH:K704:FOFFset <discrete> 3-9
:SOURce:CLOCK:PDH:K704:FOFFset:OFFSet <numeric> 3-10
:SOURce:CLOCK:PDH:M140:FOFFset <discrete> 3-12
:SOURce:CLOCK:PDH:M140:FOFFset:OFFSet <numeric> 3-13
:SOURce:CLOCK:PDH:M2:FOFFset <discrete> 3-10
:SOURce:CLOCK:PDH:M2:FOFFset:OFFSet <numeric> 3-10
:SOURce:CLOCK:PDH:M34:FOFFset <discrete> 3-12
:SOURce:CLOCK:PDH:M34:FOFFset:OFFSet <numeric> 3-12
:SOURce:CLOCK:PDH:M8:FOFFset <discrete> 3-11
:SOURce:CLOCK:PDH:M8:FOFFset:OFFSet <numeric> 3-11
:SOURce:CLOCK:PDH:SOURce <discrete> 3-9
:SOURce:CLOCK:SDH:FOFFset <boolean> 4-8
:SOURce:CLOCK:SDH:FOFFset:OFFSet <numeric>,<suffix> 4-8
:SOURce:CLOCK:SDH:FORMat <discrete> 4-7
:SOURce:CLOCK:SDH:SOURce <discrete> 4-7
:SOURce:CLOCK:SONet:FOFFset <boolean> 5-8
:SOURce:CLOCK:SONet:FOFFset:OFFSet <numeric>,<suffix> 5-8
:SOURce:CLOCK:SONet:FORMat <discrete> 5-7
:SOURce:CLOCK:SONet:SOURce <discrete> 5-7
:SOURce:CLOCK:SPDH:DS1:FOFFset <discrete> 3-22
:SOURce:CLOCK:SPDH:DS1:FOFFset:OFFSet <numeric>,<discrete> 3-23
:SOURce:CLOCK:SPDH:DS3:FOFFset <discrete> 3-21
:SOURce:CLOCK:SPDH:DS3:FOFFset:OFFSet <numeric>,<discrete> 3-22
:SOURce:CLOCK:SPDH:M140:FOFFset <discrete> 3-20
:SOURce:CLOCK:SPDH:M140:FOFFset:OFFSet <numeric>,<discrete> 3-21
:SOURce:CLOCK:SPDH:M2:FOFFset <discrete> 3-17
:SOURce:CLOCK:SPDH:M2:FOFFset:OFFSet <numeric>,<discrete> 3-18
:SOURce:CLOCK:SPDH:M34:FOFFset <discrete> 3-19

Command Index

:SOURce:CLOCK:SPDH:M34:FOFFset:OFFSet <numeric>,<discrete> 3-20
:SOURce:CLOCK:SPDH:M8:FOFFset <discrete> 3-18
:SOURce:CLOCK:SPDH:M8:FOFFset:OFFSet <numeric>,<discrete> 3-19
:SOURce:CLOCK:SPDH:SOURce <discrete> 3-17
:SOURce:DATA:TELEcom:ATM:ALARm <discrete> 6-18
:SOURce:DATA:TELEcom:ATM:BACKground:CBWidth<numeric>,<string> 6-7
:SOURce:DATA:TELEcom:ATM:BACKground:HEADer:CLP <numeric>,<string> 6-14
:SOURce:DATA:TELEcom:ATM:BACKground:HEADer:GFC <numeric>,<numeric> 6-12
:SOURce:DATA:TELEcom:ATM:BACKground:HEADer:PTI <numeric>,<string> 6-14
:SOURce:DATA:TELEcom:ATM:BACKground:HEADer:VCI <numeric>,<numeric> 6-13
:SOURce:DATA:TELEcom:ATM:BACKground:HEADer:VPI <numeric>,<numeric> 6-13
:SOURce:DATA:TELEcom:ATM:BACKground:PAYLoad:UWORD <numeric>,<string> 6-15
:SOURce:DATA:TELEcom:ATM:CBWidth <string> 6-6
:SOURce:DATA:TELEcom:ATM:DISTRibution <discrete> 6-8
:SOURce:DATA:TELEcom:ATM:DISTRibution:BSIZe <numeric> 6-9
:SOURce:DATA:TELEcom:ATM:DISTRibution:BURSt <discrete> 6-9
:SOURce:DATA:TELEcom:ATM:ERRor:BSIZe <numeric> 6-17
:SOURce:DATA:TELEcom:ATM:ERRor:BURSt <discrete> 6-17
:SOURce:DATA:TELEcom:ATM:ERRor:RATE <discrete> 6-17
:SOURce:DATA:TELEcom:ATM:ERRor:STReam <discrete> 6-16
:SOURce:DATA:TELEcom:ATM:ERRor:TYPE <discrete> 6-15
:SOURce:DATA:TELEcom:ATM:FILL <discrete> 6-15
:SOURce:DATA:TELEcom:ATM:FILL:CBWidth? <string> 6-8
:SOURce:DATA:TELEcom:ATM:HEADer:CLP <string> 6-11
:SOURce:DATA:TELEcom:ATM:HEADer:GFC <numeric> 6-10
:SOURce:DATA:TELEcom:ATM:HEADer:PTI <string> 6-11
:SOURce:DATA:TELEcom:ATM:HEADer:VCI <numeric> 6-10
:SOURce:DATA:TELEcom:ATM:HEADer:VPI <numeric> 6-10
:SOURce:DATA:TELEcom:ATM:M2:CRC4 <boolean> 6-6
:SOURce:DATA:TELEcom:ATM:NINTerface <discrete> 6-9
:SOURce:DATA:TELEcom:ATM:PAYLoad <discrete> 6-11
:SOURce:DATA:TELEcom:ATM:PAYLoad:PATtern <discrete> 6-12
:SOURce:DATA:TELEcom:ATM:PAYLoad:UWORD <string> 6-12
:SOURce:DATA:TELEcom:ATM:THRumode <boolean> 6-19
:SOURce:DATA:TELEcom:ATM:TTRace:DATA <string> 6-19
:SOURce:DATA:TELEcom:ATM:TTRace:PATtern <discrete> 6-19
:SOURce:DATA:TELEcom:ERRor:BIT <discrete> 2-12
:SOURce:DATA:TELEcom:JITTer:AMPLitude <numeric> 7-6
:SOURce:DATA:TELEcom:JITTer:ATOLerance:DELay <numeric> 7-9

Command Index

:SOURce:DATA:TELEcom:JITTer:ATOLerance:DWELl <numeric> 7-9
:SOURce:DATA:TELEcom:JITTer:ATOLerance:POINts <numeric> 7-10
:SOURce:DATA:TELEcom:JITTer:ATOLerance:THReshold <numeric> 7-10
:SOURce:DATA:TELEcom:JITTer:ERANge <discrete> 7-14
:SOURce:DATA:TELEcom:JITTer:FREQuency <numeric> 7-6
:SOURce:DATA:TELEcom:JITTer:MASK <discrete> 7-6
:SOURce:DATA:TELEcom:JITTer:MODulation <discrete> 7-14
:SOURce:DATA:TELEcom:JITTer:QFACtor <discrete> 7-7
:SOURce:DATA:TELEcom:JITTer:RANge <discrete> 7-7
:SOURce:DATA:TELEcom:JITTer:SDHMask <discrete> 7-9
:SOURce:DATA:TELEcom:JITTer:SETTings <discrete> 7-17
:SOURce:DATA:TELEcom:JITTer:TRANsfer:DELay <numeric> 7-11
:SOURce:DATA:TELEcom:JITTer:TRANsfer:DWELl <numeric> 7-11
:SOURce:DATA:TELEcom:JITTer:TRANsfer:MASK:INPut <discrete> 7-12
:SOURce:DATA:TELEcom:JITTer:TRANsfer:MASK:INPut:A1 <numeric> 7-12
:SOURce:DATA:TELEcom:JITTer:TRANsfer:MASK:INPut:A2 <numeric> 7-12
:SOURce:DATA:TELEcom:JITTer:TRANsfer:MASK:INPut:F1 <numeric> 7-13
:SOURce:DATA:TELEcom:JITTer:TRANsfer:MASK:INPut:F2 <numeric> 7-13
:SOURce:DATA:TELEcom:JITTer:TRANsfer:MASK:INPut:F3 <numeric> 7-13
:SOURce:DATA:TELEcom:JITTer:TRANsfer:MASK:INPut:F4 <numeric> 7-13
:SOURce:DATA:TELEcom:JITTer:TRANsfer:MASK:PASS <discrete> 7-14
:SOURce:DATA:TELEcom:JITTer:TRANsfer:MODE <discrete> 7-10
:SOURce:DATA:TELEcom:JITTer:TRANsfer:POINts <numeric> 7-11
:SOURce:DATA:TELEcom:JITTer:WANDer:AMPLitude <numeric> 7-16
:SOURce:DATA:TELEcom:JITTer:WANDer:FREQuency <numeric> 7-15
:SOURce:DATA:TELEcom:JITTer:WANDer:MASK <discrete> 7-15
:SOURce:DATA:TELEcom:PDH:BINary:POLarity:CLOCK <discrete> 3-15
:SOURce:DATA:TELEcom:PDH:BINary:POLarity:DATA <discrete> 3-15
:SOURce:DATA:TELEcom:PDH:BINary:THReshold:CLOCK <discrete> 3-14
:SOURce:DATA:TELEcom:PDH:BINary:THReshold:DATA <discrete> 3-15
:SOURce:DATA:TELEcom:PDH:ERRor:RATE <discrete> 3-14
:SOURce:DATA:TELEcom:PDH:PAYLoad:PATTern <discrete> 3-13
:SOURce:DATA:TELEcom:PDH:PAYLoad:UWORD <string> 3-14
:SOURce:DATA:TELEcom:SDH:ALARm <discrete> 4-41
:SOURce:DATA:TELEcom:SDH:ALARm:SOOFrAmE 4-42
:SOURce:DATA:TELEcom:SDH:AU:TYPE <discrete> 4-11
:SOURce:DATA:TELEcom:SDH:AU3 <numeric> 4-12
:SOURce:DATA:TELEcom:SDH:AU3:BACKground:PAYLoad:PATTern:UWORD <numeric>, <string> 4-19

Command Index

:SOURCE:DATA:TELEcom:SDH:AU3:BACKground:PAYLoad:TYPE <numeric>, <discrete> 4-18
:SOURCE:DATA:TELEcom:SDH:ERRor:MSPThreshold:EINTerval <discrete> 4-40
:SOURCE:DATA:TELEcom:SDH:ERRor:MSPThreshold:NERRors <numeric> 4-40
:SOURCE:DATA:TELEcom:SDH:ERRor:RATE <discrete> 4-37
:SOURCE:DATA:TELEcom:SDH:ERRor:TYPE <discrete> 4-36
:SOURCE:DATA:TELEcom:SDH:IDCC <discrete> 4-60
:SOURCE:DATA:TELEcom:SDH:IDCC:POLarity <discrete> 4-60
:SOURCE:DATA:TELEcom:SDH:MAPPing <discrete> 4-13
:SOURCE:DATA:TELEcom:SDH:MSPMessages:ARCHitecture <discrete> 4-56
:SOURCE:DATA:TELEcom:SDH:MSPMessages:BRIDge <string> 4-56
:SOURCE:DATA:TELEcom:SDH:MSPMessages:CHANnel <numeric> 4-55
:SOURCE:DATA:TELEcom:SDH:MSPMessages:DNODE <string> 4-58
:SOURCE:DATA:TELEcom:SDH:MSPMessages:DOWNload 4-60
:SOURCE:DATA:TELEcom:SDH:MSPMessages:PCODE <discrete> 4-59
:SOURCE:DATA:TELEcom:SDH:MSPMessages:RCODE <discrete> 4-57
:SOURCE:DATA:TELEcom:SDH:MSPMessages:REQuest <discrete> 4-54
:SOURCE:DATA:TELEcom:SDH:MSPMessages:REServed <numeric> 4-57
:SOURCE:DATA:TELEcom:SDH:MSPMessages:SCODE <discrete> 4-59
:SOURCE:DATA:TELEcom:SDH:MSPMessages:SNODE <string> 4-59
:SOURCE:DATA:TELEcom:SDH:MSPMessages:TOPology <discrete> 4-54
:SOURCE:DATA:TELEcom:SDH:OBERTest <discrete> 4-62
:SOURCE:DATA:TELEcom:SDH:OBERTest:CHANnel <discrete> 4-61
:SOURCE:DATA:TELEcom:SDH:OBERTest:CHANnel:SElect <numeric> 4-62
:SOURCE:DATA:TELEcom:SDH:OBERTest:COLumn <numeric> 4-61
:SOURCE:DATA:TELEcom:SDH:OVERhead:DATA <numeric>, <numeric>, <discrete>, <string> 4-23
:SOURCE:DATA:TELEcom:SDH:OVERhead:DATA:HEXadecimal <numeric>, <numeric>, <discrete>, <string> 4-24
:SOURCE:DATA:TELEcom:SDH:OVERhead:DEFault 4-23
:SOURCE:DATA:TELEcom:SDH:OVERhead:J0 <string> 4-29
:SOURCE:DATA:TELEcom:SDH:OVERhead:J0:HEXadecimal? 4-29
:SOURCE:DATA:TELEcom:SDH:OVERhead:J0:PATtern <discrete> 4-28
:SOURCE:DATA:TELEcom:SDH:OVERhead:SBYTE <discrete> 4-34
:SOURCE:DATA:TELEcom:SDH:PAYLoad <discrete> 4-12
:SOURCE:DATA:TELEcom:SDH:PAYLoad:OFFSet <numeric> 4-17
:SOURCE:DATA:TELEcom:SDH:PAYLoad:PATtern <discrete> 4-16
:SOURCE:DATA:TELEcom:SDH:PAYLoad:STRucture <discrete> 4-15
:SOURCE:DATA:TELEcom:SDH:PAYLoad:TYPE <discrete> 4-15
:SOURCE:DATA:TELEcom:SDH:PAYLoad:UWORD <string> 4-17
:SOURCE:DATA:TELEcom:SDH:PDHPayload:ERRor:RATE <discrete> 4-39

Command Index

:SOURCE:DATA:TELEcom:SDH:PDHPayload:ERROR:RATE:USER <numeric> 4-39
:SOURCE:DATA:TELEcom:SDH:PDHPayload:ERROR:TYPE <discrete> 4-38
:SOURCE:DATA:TELEcom:SDH:POINter <discrete> 4-42
:SOURCE:DATA:TELEcom:SDH:POINter:ACTion 4-43
:SOURCE:DATA:TELEcom:SDH:POINter:ADJust 4-45
:SOURCE:DATA:TELEcom:SDH:POINter:DIRection <discrete> 4-42
:SOURCE:DATA:TELEcom:SDH:POINter:G783 <discrete> 4-46
:SOURCE:DATA:TELEcom:SDH:POINter:G783:INTerval <numeric>,<suffix> 4-48
:SOURCE:DATA:TELEcom:SDH:POINter:G783:PATTern <discrete> 4-47
:SOURCE:DATA:TELEcom:SDH:POINter:G783:POLarity <discrete> 4-48
:SOURCE:DATA:TELEcom:SDH:POINter:G783:SEQuence <discrete> 4-49
:SOURCE:DATA:TELEcom:SDH:POINter:G783:SINGle <discrete> 4-47
:SOURCE:DATA:TELEcom:SDH:POINter:IDECrement <numeric> 4-43
:SOURCE:DATA:TELEcom:SDH:POINter:NPOinter <discrete> 4-45
:SOURCE:DATA:TELEcom:SDH:POINter:OFFSet <discrete> 4-45
:SOURCE:DATA:TELEcom:SDH:POINter:OFFSet:RATE <numeric>,<suffix> 4-45
:SOURCE:DATA:TELEcom:SDH:POINter:TRANsmitted? 4-43
:SOURCE:DATA:TELEcom:SDH:POINter:TYPE <discrete> 4-42
:SOURCE:DATA:TELEcom:SDH:POINter:VALue <numeric> 4-44
:SOURCE:DATA:TELEcom:SDH:POVerhead:DATA <discrete>,<string> 4-25
:SOURCE:DATA:TELEcom:SDH:POVerhead:H4Sequence <discrete> 4-34
:SOURCE:DATA:TELEcom:SDH:POVerhead:J1 <string> 4-27
:SOURCE:DATA:TELEcom:SDH:POVerhead:J1:CRC7 <string> 4-27
:SOURCE:DATA:TELEcom:SDH:POVerhead:J1:HEXadecimal? 4-28
:SOURCE:DATA:TELEcom:SDH:POVerhead:J1:PATTern <discrete> 4-26
:SOURCE:DATA:TELEcom:SDH:POVerhead:SLABel <discrete> 4-26
:SOURCE:DATA:TELEcom:SDH:PRBS:POLarity <discrete> 4-17
:SOURCE:DATA:TELEcom:SDH:PRIMary:BACKground:PAYLoad:PATTern <discrete> 4-20
:SOURCE:DATA:TELEcom:SDH:SEQuence <discrete> 4-49
:SOURCE:DATA:TELEcom:SDH:SEQuence:CHANnel <discrete> 4-50
:SOURCE:DATA:TELEcom:SDH:SEQuence:CHANnel:SElect <numeric> 4-51
:SOURCE:DATA:TELEcom:SDH:SEQuence:COLumn <numeric> 4-51
:SOURCE:DATA:TELEcom:SDH:SEQuence:DATA <discrete>,<string> 4-51
:SOURCE:DATA:TELEcom:SDH:SEQuence:FCOUNT <numeric>,<numeric> 4-52
:SOURCE:DATA:TELEcom:SDH:SEQuence:MODE <discrete> 4-49
:SOURCE:DATA:TELEcom:SDH:SEQuence:OHBYte <discrete> 4-50
:SOURCE:DATA:TELEcom:SDH:SEQuence:ORder <discrete>,<discrete>,<discrete>,<discrete>,<discrete> 4-52
:SOURCE:DATA:TELEcom:SDH:STESt:BLENght <numeric> 4-53

Command Index

:SOURCE:DATA:TELEcom:SDH:STESt:SPATtern <discrete> 4-53
:SOURCE:DATA:TELEcom:SDH:TFUNction:TYPE <discrete> 4-36
:SOURCE:DATA:TELEcom:SDH:THRumode <discrete> 4-9
:SOURCE:DATA:TELEcom:SDH:THRumode:COVerwrite <boolean> 4-10
:SOURCE:DATA:TELEcom:SDH:THRumode:POVerwrite <payload> 4-9
:SOURCE:DATA:TELEcom:SDH:TRIButary <numeric> 4-14
:SOURCE:DATA:TELEcom:SDH:TRIButary:CONCatenate <numeric>, <numeric> 4-18
:SOURCE:DATA:TELEcom:SDH:TRIButary:MAPPING <discrete> 4-13
:SOURCE:DATA:TELEcom:SDH:TRIButary:POINter:TRANsmitted? 4-44
:SOURCE:DATA:TELEcom:SDH:TRIButary:POINter:VALue <numeric> 4-44
:SOURCE:DATA:TELEcom:SDH:TRIButary:POVerhead:C2:SLABel <discrete> 4-32
:SOURCE:DATA:TELEcom:SDH:TRIButary:POVerhead:DATA <discrete>, <string> 4-28
:SOURCE:DATA:TELEcom:SDH:TRIButary:POVerhead:J1 <string> 4-30
:SOURCE:DATA:TELEcom:SDH:TRIButary:POVerhead:J1:CRc7 <string> 4-30
:SOURCE:DATA:TELEcom:SDH:TRIButary:POVerhead:J1:HEXadecimal? 4-31
:SOURCE:DATA:TELEcom:SDH:TRIButary:POVerhead:J1:PATTern <discrete> 4-29
:SOURCE:DATA:TELEcom:SDH:TRIButary:POVerhead:J2 <string> 4-31
:SOURCE:DATA:TELEcom:SDH:TRIButary:POVerhead:J2:FIXed <string> 4-32
:SOURCE:DATA:TELEcom:SDH:TRIButary:POVerhead:J2:HEXadecimal? 4-32
:SOURCE:DATA:TELEcom:SDH:TRIButary:POVerhead:J2:PATTern <discrete> 4-31
:SOURCE:DATA:TELEcom:SDH:TRIButary:POVerhead:V5:SLABel <numeric> 4-32
:SOURCE:DATA:TELEcom:SDH:TUG2 <numeric> 4-14
:SOURCE:DATA:TELEcom:SDH:TUG3 <numeric> 4-14
:SOURCE:DATA:TELEcom:SDH:TUG3:BACKground:PAYLoad:PATTern <numeric> <discrete> 4-20
:SOURCE:DATA:TELEcom:SDH:TUG3:BACKground:PAYLoad:PATTern:UWORD <numeric>
<string> 4-21
:SOURCE:DATA:TELEcom:SDH:VC4 <numeric> 4-11
:SOURCE:DATA:TELEcom:SDH:VC4:BACKground <discrete> 4-20
:SOURCE:DATA:TELEcom:SONet:ALARm <discrete> 5-37
:SOURCE:DATA:TELEcom:SONet:ALARm:SSEFrame 5-38
:SOURCE:DATA:TELEcom:SONet:APSMessages:ARCHitecture <discrete> 5-52
:SOURCE:DATA:TELEcom:SONet:APSMessages:BRIDge <string> 5-51
:SOURCE:DATA:TELEcom:SONet:APSMessages:CHANnel <numeric> 5-50
:SOURCE:DATA:TELEcom:SONet:APSMessages:DNODE <string> 5-53
:SOURCE:DATA:TELEcom:SONet:APSMessages:DOWNload 5-55
:SOURCE:DATA:TELEcom:SONet:APSMessages:PCODE <discrete> 5-54
:SOURCE:DATA:TELEcom:SONet:APSMessages:RCODE <discrete> 5-53
:SOURCE:DATA:TELEcom:SONet:APSMessages:REQuest <discrete> 5-49
:SOURCE:DATA:TELEcom:SONet:APSMessages:REServed <numeric> 5-52

Command Index

:SOURCE:DATA:TELEcom:SONet:APSMessages:SCODE <discrete> 5-55
:SOURCE:DATA:TELEcom:SONet:APSMessages:SNODE <string> 5-54
:SOURCE:DATA:TELEcom:SONet:APSMessages:TOPology <discrete> 5-49
:SOURCE:DATA:TELEcom:SONet:ERROR:APSThreshold:EINTerval <discrete> 5-37
:SOURCE:DATA:TELEcom:SONet:ERROR:APSThreshold:NERRors <numeric> 5-36
:SOURCE:DATA:TELEcom:SONet:ERROR:RATE <discrete> 5-33
:SOURCE:DATA:TELEcom:SONet:ERROR:TYPE <discrete> 5-32
:SOURCE:DATA:TELEcom:SONet:IDCC <discrete> 5-55
:SOURCE:DATA:TELEcom:SONet:IDCC:POLarity <discrete> 5-56
:SOURCE:DATA:TELEcom:SONet:MAPPING <discrete> 5-13
:SOURCE:DATA:TELEcom:SONet:OBERTest <discrete> 5-57
:SOURCE:DATA:TELEcom:SONet:OBERTest:CHANnel <discrete> 5-56
:SOURCE:DATA:TELEcom:SONet:OBERTest:STS1 <numeric> 5-56
:SOURCE:DATA:TELEcom:SONet:OBERTest:STS3:SElect <numeric> 5-57
:SOURCE:DATA:TELEcom:SONet:OVERhead:DATA <numeric>, <numeric>, <discrete>, <string> 5-21
:SOURCE:DATA:TELEcom:SONet:OVERhead:DATA:HEXadecimal <numeric>, <numeric>, <discrete>, <string> 5-22
:SOURCE:DATA:TELEcom:SONet:OVERhead:DEFault 5-21
:SOURCE:DATA:TELEcom:SONet:OVERhead:J0 <string> 5-26
:SOURCE:DATA:TELEcom:SONet:OVERhead:J0:HEXadecimal? 5-28
:SOURCE:DATA:TELEcom:SONet:OVERhead:J0:PATTern <discrete> 5-26
:SOURCE:DATA:TELEcom:SONet:OVERhead:SBYTE <discrete> 5-30
:SOURCE:DATA:TELEcom:SONet:PAYLoad <discrete> 5-12
:SOURCE:DATA:TELEcom:SONet:PAYLoad:OFFSet <numeric> 5-17
:SOURCE:DATA:TELEcom:SONet:PAYLoad:PATTern <discrete> 5-15
:SOURCE:DATA:TELEcom:SONet:PAYLoad:STRucture <discrete> 5-15
:SOURCE:DATA:TELEcom:SONet:PAYLoad:TYPE <discrete> 5-14
:SOURCE:DATA:TELEcom:SONet:PAYLoad:UWORD <string> 5-16
:SOURCE:DATA:TELEcom:SONet:PDHPayload:ERROR:RATE <discrete> 5-35
:SOURCE:DATA:TELEcom:SONet:PDHPayload:ERROR:RATE:USER <numeric> 5-36
:SOURCE:DATA:TELEcom:SONet:PDHPayload:ERROR:TYPE <discrete> 5-34
:SOURCE:DATA:TELEcom:SONet:POINter <discrete> 5-38
:SOURCE:DATA:TELEcom:SONet:POINter:ACTIon 5-40
:SOURCE:DATA:TELEcom:SONet:POINter:ADJust 5-41
:SOURCE:DATA:TELEcom:SONet:POINter:DIRection <discrete> 5-39
:SOURCE:DATA:TELEcom:SONet:POINter:IDECrement <numeric> 5-39
:SOURCE:DATA:TELEcom:SONet:POINter:NPINter <discrete> 5-41
:SOURCE:DATA:TELEcom:SONet:POINter:OFFSet <discrete> 5-42
:SOURCE:DATA:TELEcom:SONet:POINter:OFFSet:RATE <numeric> <suffix> 5-42

Command Index

:SOURCE:DATA:TELEcom:SONet:POINter:T1105 <discrete> 5-43
:SOURCE:DATA:TELEcom:SONet:POINter:T1105:INTerval <numeric>, <suffix> 5-44
:SOURCE:DATA:TELEcom:SONet:POINter:T1105:PATTern <discrete> 5-43
:SOURCE:DATA:TELEcom:SONet:POINter:T1105:POLarity <discrete> 5-44
:SOURCE:DATA:TELEcom:SONet:POINter:T1105:SEQuence <discrete> 5-45
:SOURCE:DATA:TELEcom:SONet:POINter:TRANsmitted? 5-40
:SOURCE:DATA:TELEcom:SONet:POINter:TYPE <discrete> 5-39
:SOURCE:DATA:TELEcom:SONet:POINter:VALue <numeric> 5-40
:SOURCE:DATA:TELEcom:SONet:POVerhead:DATA <discrete>, <string> 5-23
:SOURCE:DATA:TELEcom:SONet:POVerhead:H4Sequence <discrete> 5-30
:SOURCE:DATA:TELEcom:SONet:POVerhead:J1 <string> 5-24
:SOURCE:DATA:TELEcom:SONet:POVerhead:J1:CRC7 <string> 5-25
:SOURCE:DATA:TELEcom:SONet:POVerhead:J1:HEXadecimal? 5-25
:SOURCE:DATA:TELEcom:SONet:POVerhead:J1:PATTern <discrete> 5-24
:SOURCE:DATA:TELEcom:SONet:POVerhead:SLABel <discrete> 5-23
:SOURCE:DATA:TELEcom:SONet:PRBS:POLarity <discrete> 5-16
:SOURCE:DATA:TELEcom:SONet:PRIMary:BACKground:PAYLoad:PATTern <discrete> 5-19
:SOURCE:DATA:TELEcom:SONet:SEQuence <discrete> 5-45
:SOURCE:DATA:TELEcom:SONet:SEQuence:DATA <discrete>, <string> 5-47
:SOURCE:DATA:TELEcom:SONet:SEQuence:FCOUNT <numeric>, <numeric> 5-48
:SOURCE:DATA:TELEcom:SONet:SEQuence:MODE <discrete> 5-45
:SOURCE:DATA:TELEcom:SONet:SEQuence:OHBYte <discrete> 5-46
:SOURCE:DATA:TELEcom:SONet:SEQuence:ORDER <discrete>, <discrete>, <discrete>, <discrete>, <discrete> 5-47
:SOURCE:DATA:TELEcom:SONet:SEQuence:STS1 <numeric> 5-46
:SOURCE:DATA:TELEcom:SONet:SEQuence:STS3:SElect <numeric> 5-46
:SOURCE:DATA:TELEcom:SONet:SPE:TYPE <discrete> 5-11
:SOURCE:DATA:TELEcom:SONet:STESt:BLENght <numeric> 5-48
:SOURCE:DATA:TELEcom:SONet:STESt:SPATtern <discrete> 5-48
:SOURCE:DATA:TELEcom:SONet:STS1 <numeric> 5-12
:SOURCE:DATA:TELEcom:SONet:STS1:BACKground:PAYLoad:PATTern:UWORD <numeric>, <string> 5-19
:SOURCE:DATA:TELEcom:SONet:STS1:BACKground:PAYLoad:TYPE <numeric>, <discrete> 5-18
:SOURCE:DATA:TELEcom:SONet:STS3 <numeric> 5-11
:SOURCE:DATA:TELEcom:SONet:STS3:BACKground <discrete> 5-19
:SOURCE:DATA:TELEcom:SONet:TFUNction:TYPE <discrete> 5-32
:SOURCE:DATA:TELEcom:SONet:THRumode <discrete> 5-9
:SOURCE:DATA:TELEcom:SONet:THRumode:COVerwrite <boolean> 5-10
:SOURCE:DATA:TELEcom:SONet:THRumode:POVerwrite <payload> 5-9

Command Index

:SOURce:DATA:TELEcom:SONet:TRIButary <numeric> 5-14
:SOURce:DATA:TELEcom:SONet:TRIButary:CONCatenate <numeric>, <numeric> 5-17
:SOURce:DATA:TELEcom:SONet:TRIButary:MAPPing <discrete> 5-13
:SOURce:DATA:TELEcom:SONet:TRIButary:POINter:TRANsmitted? 5-40
:SOURce:DATA:TELEcom:SONet:TRIButary:POINter:VALue <numeric> 5-41
:SOURce:DATA:TELEcom:SONet:TRIButary:POVerhead:DATA <discrete>, <string> 5-25
:SOURce:DATA:TELEcom:SONet:TRIButary:POVerhead:J2 <string> 5-28
:SOURce:DATA:TELEcom:SONet:TRIButary:POVerhead:J2:FIXed <string> 5-29
:SOURce:DATA:TELEcom:SONet:TRIButary:POVerhead:J2:HEXadecimal? 5-29
:SOURce:DATA:TELEcom:SONet:TRIButary:POVerhead:J2:PATTern <discrete> 5-28
:SOURce:DATA:TELEcom:SONet:TRIButary:POVerhead:V5:SLABel <numeric> 5-29
:SOURce:DATA:TELEcom:SONet:VTGRoup <numeric> 5-13
:SOURce:DATA:TELEcom:SOURce <discrete> 2-11
:SOURce:DATA:TELEcom:SPDH:BINary:POLarity:CLOCK <discrete> 3-26
:SOURce:DATA:TELEcom:SPDH:BINary:POLarity:DATA <discrete> 3-27
:SOURce:DATA:TELEcom:SPDH:BINary:THReshold:CLOCK <discrete> 3-26
:SOURce:DATA:TELEcom:SPDH:BINary:THReshold:DATA <discrete> 3-27
:SOURce:DATA:TELEcom:SPDH:DS1:ALARm <discrete> 3-45
:SOURce:DATA:TELEcom:SPDH:DS3:ALARm <discrete> 3-44
:SOURce:DATA:TELEcom:SPDH:ERRor:EXZ:NUMBer <numeric> 3-40
:SOURce:DATA:TELEcom:SPDH:ERRor:FRAME:NERRored <discrete> 3-39
:SOURce:DATA:TELEcom:SPDH:ERRor:MFRame:NERRored <discrete> 3-39
:SOURce:DATA:TELEcom:SPDH:ERRor:RATE <discrete> 3-37
:SOURce:DATA:TELEcom:SPDH:ERRor:RATE:USER <numeric> 3-38
:SOURce:DATA:TELEcom:SPDH:ERRor:TYPE <discrete> 3-37
:SOURce:DATA:TELEcom:SPDH:FEAC <discrete> 3-40
:SOURce:DATA:TELEcom:SPDH:FEAC:BURSt <numeric> 3-40
:SOURce:DATA:TELEcom:SPDH:FEAC:CODE <string> 3-41
:SOURce:DATA:TELEcom:SPDH:FEAC:LOOPback:ACTion <discrete> 3-41
:SOURce:DATA:TELEcom:SPDH:FEAC:LOOPback:BURSt <numeric>, <numeric> 3-42
:SOURce:DATA:TELEcom:SPDH:FEAC:LOOPback:MESSAge <numeric> 3-41
:SOURce:DATA:TELEcom:SPDH:M140:ALARm <discrete> 3-42
:SOURce:DATA:TELEcom:SPDH:M140:SPARe <string> 3-45
:SOURce:DATA:TELEcom:SPDH:M2:ALARm <discrete> 3-44
:SOURce:DATA:TELEcom:SPDH:M2:CASMfm <string> 3-49
:SOURce:DATA:TELEcom:SPDH:M2:CASMfm? 3-49
:SOURce:DATA:TELEcom:SPDH:M2:NFAS <string> 3-47
:SOURce:DATA:TELEcom:SPDH:M2:SASequence <boolean> 3-48
:SOURce:DATA:TELEcom:SPDH:M2:SASequence:BIT <numeric> 3-48

Command Index

:SOURce:DATA:TELEcom:SPDH:M2:SASequence:BIT? 3-49
:SOURce:DATA:TELEcom:SPDH:M2:SASequence:PATtern <string> 3-48
:SOURce:DATA:TELEcom:SPDH:M2:SI <string> 3-46
:SOURce:DATA:TELEcom:SPDH:M2:SIE <string> 3-47
:SOURce:DATA:TELEcom:SPDH:M34:ALARm <discrete> 3-43
:SOURce:DATA:TELEcom:SPDH:M34:SPARe <string> 3-46
:SOURce:DATA:TELEcom:SPDH:M8:ALARm <discrete> 3-43
:SOURce:DATA:TELEcom:SPDH:M8:SPARe <string> 3-46
:SOURce:DATA:TELEcom:SPDH:PATtern <discrete> 3-23
:SOURce:DATA:TELEcom:SPDH:PAYLoad:STRUcture <discrete> 3-25
:SOURce:DATA:TELEcom:SPDH:PAYLoad:TYPE <discrete> 3-24
:SOURce:DATA:TELEcom:SPDH:PRBS:POLarity <discrete> 3-24
:SOURce:DATA:TELEcom:SPDH:TFUNction:TYPE <discrete> 3-36
:SOURce:DATA:TELEcom:SPDH:TSIGnal:BACKground <discrete> 3-33
:SOURce:DATA:TELEcom:SPDH:TSIGnal:PAYLoad <discrete> 3-28
:SOURce:DATA:TELEcom:SPDH:TSIGnal:RATE <discrete> 3-28
:SOURce:DATA:TELEcom:SPDH:TSIGnal:TRIButary:DS1 <discrete> 3-30
:SOURce:DATA:TELEcom:SPDH:TSIGnal:TRIButary:DS2 <discrete> 3-31
:SOURce:DATA:TELEcom:SPDH:TSIGnal:TRIButary:M2 <discrete> 3-30
:SOURce:DATA:TELEcom:SPDH:TSIGnal:TRIButary:M34 <discrete> 3-29
:SOURce:DATA:TELEcom:SPDH:TSIGnal:TRIButary:M8 <discrete> 3-29
:SOURce:DATA:TELEcom:SPDH:TSIGnal:TSLot:DS1:K56 <numeric> 3-31
:SOURce:DATA:TELEcom:SPDH:TSIGnal:TSLot:DS1:K56XN <string> 3-33
:SOURce:DATA:TELEcom:SPDH:TSIGnal:TSLot:DS1:K64 <numeric> 3-31
:SOURce:DATA:TELEcom:SPDH:TSIGnal:TSLot:DS1:K64XN <string> 3-33
:SOURce:DATA:TELEcom:SPDH:TSIGnal:TSLot:M2:K64 <numeric> 3-32
:SOURce:DATA:TELEcom:SPDH:TSIGnal:TSLot:M2:K64XN <string> 3-32
:SOURce:DATA:TELEcom:SPDH:TSLot:SIGNaling:DATA:DS1:D4 <string> 3-34
:SOURce:DATA:TELEcom:SPDH:TSLot:SIGNaling:DATA:DS1:ESF <string> 3-34
:SOURce:DATA:TELEcom:SPDH:TSLot:SIGNaling:DATA:DS1:SLC96 <string> 3-35
:SOURce:DATA:TELEcom:SPDH:TSLot:SIGNaling:DATA:M2 <string> 3-26
:SOURce:DATA:TELEcom:SPDH:UWORd <string> 3-24
:SOURce:DATA:TELEcom:TFUNction <discrete> 2-12
:SOURce:DATA:TELEcom:TFUNction:SDISruption <boolean> 3-36
:STATus:<Status Register>:CONDition? 2-46
:STATus:<Status Register>:ENABle <numeric> 2-45
:STATus:<Status Register>:EVENt? 2-45
:STATus:<Status Register>:HISTory? 2-46
:STATus:<Status Register>:NTRansition <numeric> 2-45

Command Index

:STATus:<Status Register>:NTRansition? 2-45
:STATus:<Status Register>:PTRansition <numeric> 2-45
:STATus:CHIStory 2-44
:STATus:PRESet 2-44
:SYSTem:BEEPer:STATe <boolean> 2-60
:SYSTem:COMMunicate:SERial:BAUD <rate> 2-58
:SYSTem:COMMunicate:SERial:MODE <type> 2-58
:SYSTem:COMMunicate:SERial:PARity <type> 2-59
:SYSTem:COMMunicate:SERial:SBITs <numeric> 2-59
:SYSTem:COMMunicate:SERial:XON <type> 2-59
:SYSTem:CONF <block> 2-48
:SYSTem:DATE <year>,<month>,<day> 2-47
:SYSTem:DISK:CD <string> 2-58
:SYSTem:DISK:DIRectory:CREate <filename> 2-57
:SYSTem:DISK:DIRectory? <extension>,<format> 2-57
:SYSTem:DISK:FILE:COPY:SMG <store>,<directory>,<filename>,<overwrite> 2-56
:SYSTem:DISK:FILE:COPY:SMG:FORMat <type> 2-56
:SYSTem:DISK:FILE:DELeTe <filename> 2-56
:SYSTem:DISK:FILE:REName <from_filename>,<to_dir>,<filename>,<overwrite> 2-57
:SYSTem:DISK:FILE:COPY:CNF <to>,<store>,<directory>,<filename>,<overwrite> 2-55
:SYSTem:DISK:FORMat 2-54
:SYSTem:DISK:FREE? 2-58
:SYSTem:DISK:Label <string> 2-54
:SYSTem:DISK:PWD? 2-57
:SYSTem:DISK:RECall <extension>,<filename>,<confirm> 2-55
:SYSTem:DISK:SAVE <extension>,<filename>,<overwrite> 2-54
:SYSTem:DISK:SAVE:MODE <discrete> 2-54
:SYSTem:ERRor? 2-49
:SYSTem:KLOCK <boolean> 2-48
:SYSTem:LOCAL 2-48
:SYSTem:LOGGing:DEVice <type> 2-53
:SYSTem:PRESet 2-48
:SYSTem:PRINt 2-49
:SYSTem:PRINt:AUTO <boolean> 2-49
:SYSTem:PRINt:CONTent <content> 2-51
:SYSTem:PRINt:DEMAND:MODE <mode> 2-53
:SYSTem:PRINt:ESEConds <boolean> 2-52
:SYSTem:PRINt:MODE <mode> 2-52
:SYSTem:PRINt:PERiod <period> 2-49

Command Index

:SYSTem:PRINt:RESults <type> 2-50
:SYSTem:PRINt:SPAN <content> 2-51
:SYSTem:PRINt:UPERiod <numeric>,<discrete> 2-50
:SYSTem:PRINt:WHEN <select> 2-52
:SYSTem:REMote 2-48
:SYSTem:SERial? 2-48
:SYSTem:SSETting:LABel <numeric>,<title> 2-60
:SYSTem:SSETting:LOCK <boolean> 2-60
:SYSTem:TELEcom:PDH:MODE <discrete> 2-61
:SYSTem:TIME <hour>,<minute>,<second> 2-47
:SYSTem:VERSion? 2-49
:SYSTem:WINDow<type> 2-47

Hewlett-Packard Sales and Service Offices

If you need technical assistance with a Hewlett-Packard test and measurement product or application please contact the Hewlett-Packard office or distributor in your country.

Asia Pacific:

Hong Kong:

Tel: (852) 2599 7889

India:

Tel: (91-11) 682-6000

Japan:

Hewlett-Packard Japan Ltd.
Measurement Assistance Center
9-1, Takakura-Cho, Hachioji-Shi,
Tokyo 192, Japan

Tel: (81) 426-56-7832

Fax: (81) 426-56-7840

Korea:

Tel: (82-2) 769 0800

Malaysia:

Tel: (60-3) 291 0213

Philippines:

Tel: (63-2) 894 1451

People's Republic of China:

Tel: (86-10) 6505 0149

Singapore:

Tel: (1800) 292 8100

Taiwan:

Tel: (886-3) 492 9666

Thailand:

Tel: (66-2) 661 3900

For countries in Asia Pacific not listed, contact:

Hewlett-Packard Asia Pacific Ltd
17-21/F Shell Tower, Times Square,
1 Matheson Street
Causeway Bay
Hong Kong
Tel: (852) 2599 7777
Fax: (852) 2506 9285

Australia/New Zealand:

Hewlett-Packard Australia Ltd.
31-41 Joseph Street
Blackburn, Victoria 3130
Australia
Tel: 1 800 629 485

Canada:

Hewlett-Packard Canada Ltd.
5150 Spectrum Way
Mississauga, Ontario
L4W 5G1
Tel: (905) 206 4725

Europe, Africa and Middle East:

Austria:

Tel: (0)1 25000-0

Belgium and Luxembourg:

Tel: (02) 778 3417

Baltic Countries:

Tel: (358) 08872 2100

Czech Republic:

Tel: (0042) 2-4743111

Denmark:

Tel: 45 99 10 00

Hewlett-Packard Sales and Service Offices (cont'd)

Finland:

Tel: (90) 88 721

France:

Tel: (0)1 69.82.60.60

Germany:

Tel: (0180) 532 62-33

Greece:

Tel: (1) 7264045

Hungary:

Tel: (1) 252 4705

Ireland:

Tel: (01) 284 4633

Israel:

Tel: (03) 5380 333

Italy:

Tel: 02 - 92 122 241

Netherlands:

Tel: (020) 547 6669

Norway:

Tel: (22) 73 57 50

Poland:

Tel: (22) 608 7700

Portugal:

Tel: (11) 482 85 00

Russia:

Tel: (7/095) 928 6885

Fax: (7/095) 916 9844

South Africa:

Tel: (011) 806 1000

Spain:

Tel: (34) 1 631 1323

Sweden:

Tel: (08) 444 22 77

Switzerland:

Tel: (01) 735 7111

Turkey:

Tel: (212) 224 59 25

United Kingdom:

Tel: (01344) 366 666

***For countries in Europe/Middle East
and Africa not listed, contact:***

Hewlett-Packard
International Sales Europe
Geneva, Switzerland
Tel: +41-22-780-4111
Fax: +41-22-780-4770

Latin America:

Hewlett-Packard
Latin American Region Headquarters
5200 Blue Lagoon Drive
9th Floor
Miami, Florida 33126
U.S.A.
Tel: (305) 267-4245
Tel: (305) 267-4220
Fax: (305) 267-4288

United States:

Hewlett-Packard Company
Test and Measurement Organization
5301 Stevens Creek Blvd.
Bldg. 51L-SC
Santa Clara, CA 95052-8059
Tel: 1 800 452 4844

Edition History

Edition 1 of the 37717C Remote Control manual used part number 37717-90404. It documented the product as of March 1998.

Edition dates are as follows:
1st Edition, 03/98,
2nd Edition 11/98

About This Edition

This is the 2nd edition of the 37717C Remote Control manual. It documents the product as of November 1998, and is a direct replacement for edition 1.

© Copyright Hewlett-Packard Ltd. 1998. All rights reserved. Reproduction, adaption, or translation without prior written permission is prohibited, except as allowed under the copyright laws.

In This Book

This book contains the information required for remote control of the HP 37717C Communications Performance Analyzer.

